

Détail P  
Echelle : 1:5

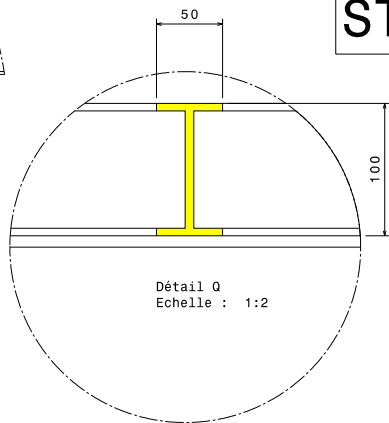

Détail Q  
Echelle : 1:2

# STRUCTURE

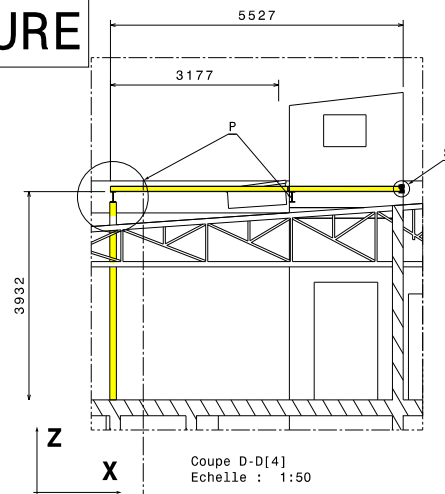

Coupe D-D[4]  
Echelle : 1:50

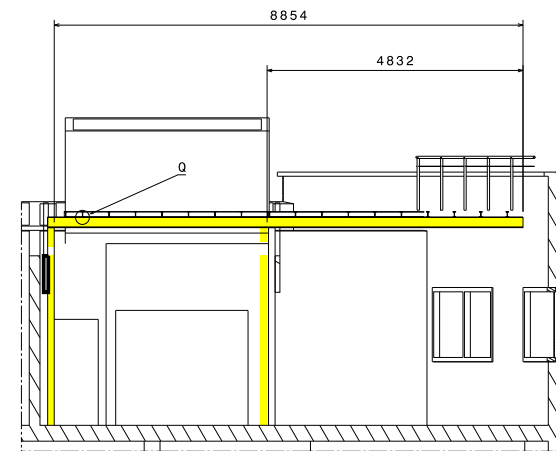

Coupe J-J[2]  
Echelle : 1:50

PROFIL	LONGUEUR mm	Qt	tarif /m	Tarif total	Kg/m	Masse totale	
IPE 200	8976	1				228	
	3521	1				89	
<b>tot IPE200</b>	<b>12.5 m</b>		<b>119</b>	<b>1492</b>	<b>25.41</b>	<b>317</b>	
IPE 100	3378	9				31	
	6577	5				60	
	6401	1				58	
	4533	1					
	3328	1					
	1862	1					
<b>tot IPE100</b>	<b>85 m</b>		<b>35</b>	<b>2975</b>	<b>9.13</b>	<b>776</b>	
UPE 100	3850	1				46	
	2926	2					
	2150	1					
<b>tot UPE100</b>	<b>12 m</b>		<b>47</b>	<b>564</b>	<b>11.88</b>	<b>143</b>	
CARRE 120x120x3	3950	2				48	
<b>tot CARRE</b>	<b>7,9 m</b>		<b>47</b>	<b>357</b>	<b>12</b>	<b>96</b>	
<b>TOTAL</b>				<b>5388</b>		<b>1333 Kg</b>	

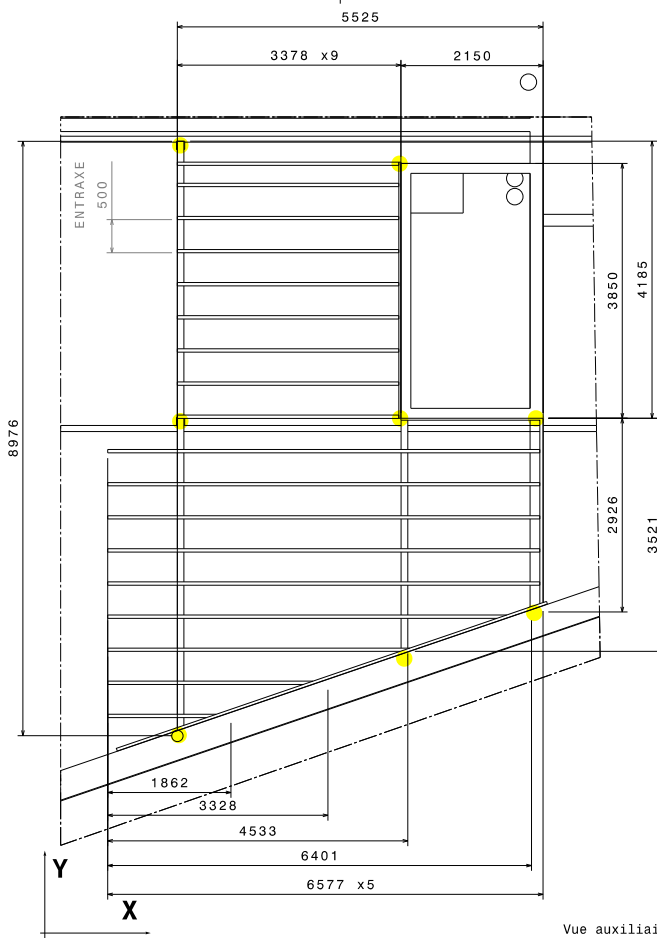

Vue auxiliaire O  
Echelle : 1:40

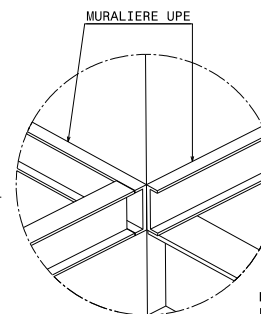

Détail R  
Echelle : 1:5

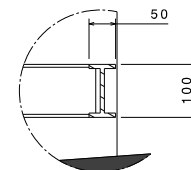

Détail S  
Echelle : 1:5

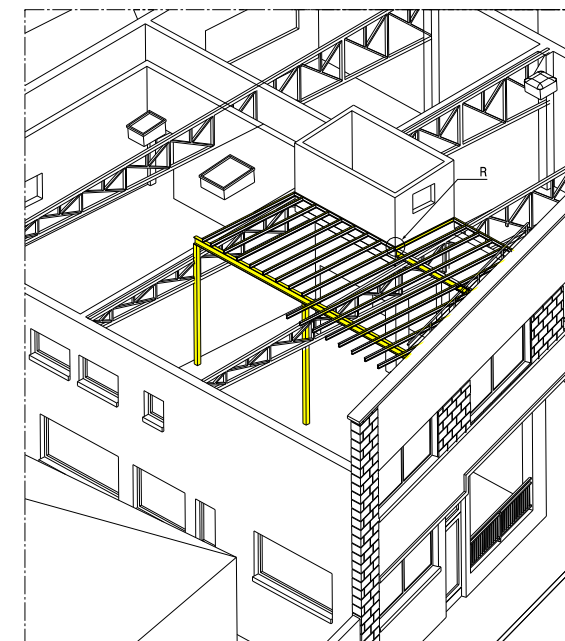

Vue isométrique[3]  
Echelle : 1:70