

41 8227

17 8469

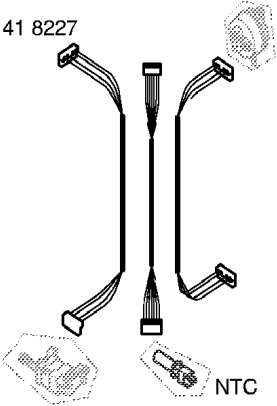

17 8470

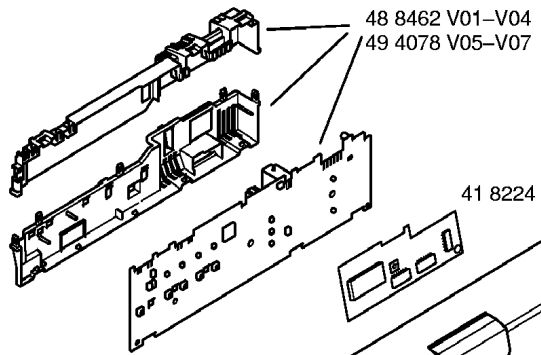

41 8224

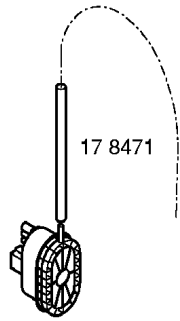
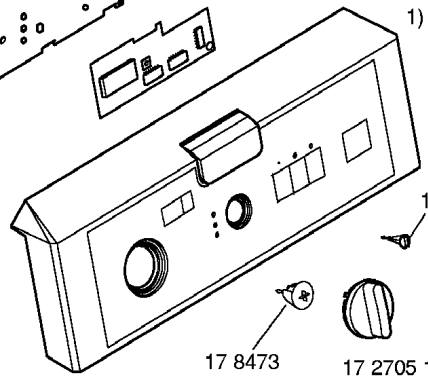

18 9707

17 8471

