

TA-1140

GEP and NEP Model

INTEGRATED STEREO AMPLIFIER

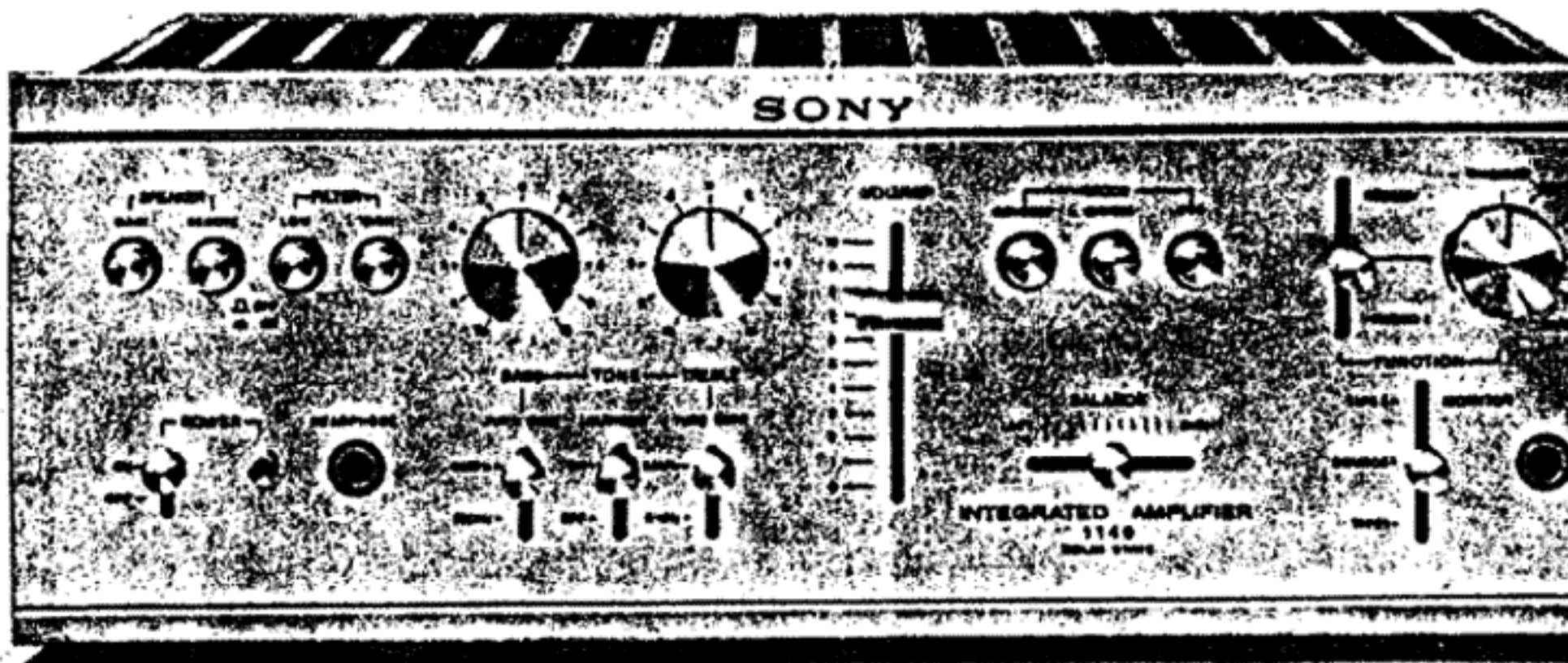

SONY®
SERVICE MANUAL

TABLE OF CONTENTS

	<u>Title</u>	<u>Page</u>
SECTION 1.	TECHNICAL DESCRIPTION	
1-1.	Technical Specifications	1
1-2.	Detailed Circuit Analysis	2 ~ 6
1-3.	Block Diagram	7
1-4.	Level Diagram	8
SECTION 2.	DISASSEMBLY AND REPLACEMENT PROCEDURES	
2-1.	Tools Required	9
2-2.	Hardware Identification Guide	9
2-3.	Top Cover and Front Panel Removal	9
2-4.	Front Subchassis Removal	10
2-5.	Rear Panel Removal	10
2-6.	Control and Switch Replacement	11
2-7.	Printed Circuit Board Removal	12
2-8.	Power Transistor Replacement	13
2-9.	Chassis Layout	13
SECTION 3.	ADJUSTMENTS	
3-1.	Dc Bias Adjustment	14
SECTION 4.	DIAGRAMS	
4-1.	Schematic Diagram – Preamplifier Section –	15 ~ 16
4-2.	Schematic Diagram – Power Amplifier Section –	17 ~ 18
4-3.	Mounting Diagram – Volume/Loudness Control Board –	19
4-4.	Mounting Diagram – Preamplifier/Power Supply Board –	20 ~ 21
4-5.	Mounting Diagram – Equalizer Amplifier Board –	22 ~ 23
4-6.	Mounting Diagram – Power Amplifier/Power Supply Board –	24 ~ 25
4-7.	Mounting Diagram – Speaker Switch Board –	26
SECTION 5.	REPACKING	27
SECTION 6.	EXPLODED VIEWS	28 ~ 29
SECTION 7.	ELECTRICAL PARTS LIST	30 ~ 32

SECTION 1

TECHNICAL DESCRIPTION

1-1. TECHNICAL SPECIFICATIONS

Technical specifications for the TA-1140 are listed in Table 1-1.

TABLE 1-1.
TA-1140 TECHNICAL SPECIFICATIONS

Power Amplifier Section	
Dynamic power:	190 watts, both channels operating, 4 ohms 120 watts, both channels operating, 8 ohms
RMS power:	50 watts per channel, both channels operating, 4 ohms 40 watts, per channel, both channels operating, 8 ohms
Rated output:	35 watts per channel, both channels operating, 8 ohms
Power bandwidth:	6 Hz to 35 kHz, IHF
Harmonic distortion: (20 Hz ~ 20 kHz)	Less than 0.1% at rated output
IM distortion:	Less than 0.1% at rated output
Input impedance:	100 k ohms
Input sensitivity: (for rated output)	0.85 V
Signal-to-noise ratio:	greater than 110 dB (shorted input)
Residual noise:	Less than 0.05 μ W (8 ohm)

Preamplifier Section

Frequency response:	PHONO-1, -2: R1AA curve ± 0.5 dB TUNER, AUX-1, -2, } 15 Hz to TAPE-1, -2 } 80 kHz. REC/PB (input) } ± 2 dB
Input sensitivity and impedance:	PHONO-1, -2: 1.2 mV 47 k ohms TUNER, AUX-1, -2, } 130 mV TAPE-1, -2 } 100 k REC/PB (input) } ohms

Signal output and output impedance:	REC OUT: 130 mV 10 k ohms PRE OUT: 1V 3 k ohms REC/PB (output): 30 mV 80 k ohms
Signal-to-noise ratio:	PHONO-1, -2: greater than 70 dB (weighting network "B") TUNER, AUX-1, -2 } greater than TAPE-1, -2 } 90 dB REC/PB } (weighting network "A")
Tone controls:	BASS ± 10 dB at 50 Hz (TURNOVER FREQ. 250 Hz) ± 10 dB at 100 Hz (TURNOVER FREQ. 500 Hz) TREBLE ± 10 dB at 10 kHz (TURNOVER FREQ. 2.5 kHz) ± 10 dB at 20 kHz (TURNOVER FREQ. 5 kHz)
Loudness control:	10 dB up at 50 Hz 3 dB up at 10 kHz (VOLUME-control attenuation: 30 dB)
Filters:	LOW: 6 dB/oct, below 70 Hz HIGH: 6 dB/oct, above 5 kHz

General

Power consumption:	200 watts
Power requirement:	100, 120, 220, 240 V, ac, 50/60 Hz
Dimensions:	400 mm (width) x 149 mm (height) x 316 mm (depth) 15 $\frac{3}{4}$ " (width) x 5 $\frac{13}{16}$ " (height) x 12 $\frac{7}{16}$ " (depth)
Net weight:	9.8 kg (21 lb 9 oz)
Shipping weight:	12.5 kg (27 lb 7 oz)

1-2. DETAILED CIRCUIT ANALYSIS

The following describes the function or operation of all stages and controls. The text sequence follows signal paths. Stages are listed by transistor reference designation at the left margin; major components are also listed in a similar manner. Refer to the block diagram on page 7 and the schematic diagrams on page 15 to 18.

Stage/Control

Function

Preamplifier Section

Equalizer
Amplifier
Q101, Q102

This direct-coupled two-stage amplifier (PNP-NPN) amplifies the small signal provided by the phono cartridge to the level required at the input of the following flat amplifier. A PNP type transistor is employed as it generates less noise than conventional NPN type transistors.

Bias circuit

Dc bias voltage for Q101 is extracted from R114 in the emitter circuit of Q102, divided by R106 and R105, and then fed back to the base of Q101 through R104 and R103. This dc negative feedback technique provides stable operation.

Equalization
circuit

RIAA equalization is achieved by the negative-feedback loop containing R110, R111, R112, C105 and C106. Be sure to use replacement components with the exact same values. R116 (R216) in the output circuit prevents interaction between left and right channel equalization when the MODE switch is set to L+R.

Stage/Control

Function

FUNCTION switch All input signals are routed to the FUNCTION-1 or FUNCTION-2 switches. Note that the TAPE-TO-TAPE positions of the FUNCTION-1 switch are provided for tape duplication as noted in Table 1-2.

TABLE 1-2.

FUNCTION-1 position	Tape Recorder-1	Tape Recorder-2
TAPE-TO-TAPE 1-2	Playback	Recording
TAPE-TO-TAPE 2-1	Recording	Playback

MONITOR
switch S3

In the TAPE-1 position, input signals connected to either the TAPE-1 terminal or REC/PB connector is selected. In the TAPE-2 position, the input program connected to the TAPE-2 terminal is selected. In the SOURCE position, all other program sources are selected.

MODE switch
S4, S6, (S5)

Select the desired mode of operation. Three push switches are provided to obtain the proper mode of operation. Notice that S5 acts as a dummy switch, therefore it is omitted from the schematic diagram. Only S4 and S6 deal with mode switch functions. These switches may also be used for test purposes. The relation between the positions of the MODE switch and outputs of the set are summarized in Table 1-3.

TABLE 1-3.

MODE Switch position	CENTER CHANNEL OUT	HEADPHONE OUT		REC OUT-1, 2 REC/PB OUT		OUTPUT	
		L-CH	R-CH	L-CH	R-CH	L-CH	R-CH
REVERSE	L+R	R	L	L	R	R	L
STEREO	L+R	L	R	L	R	L	R
L+R	L+R	L+R	L+R	L+R	L+R	L+R	L+R

Stage/Control

BALANCE control R301 (R401)

Function

Input signal is routed to the BALANCE control through MODE switches S4 and S6. This is done to optimize stereo reproduction. To eliminate insertion loss at the mechanical center of movement, a special potentiometer having a conductive coating over half its element length is used.

VOLUME control R302 (R402)

The balanced input signals from BALANCE control R301 is fed to VOLUME control R302, which regulates the signal applied to the following tone-control circuit or output circuit.

LOUDNESS switch S8

This switch and R303, C301, R304 and C302 compensate for the characteristics of the human ear which vary according to the loudness of the sound being heard. When this switch is set to ON, and the VOLUME control is set for 30 dB attenuation, the overall frequency response is increased 10 dB at 50 Hz and 3 dB at 10 kHz with reference to the level at 1 kHz.

Flat amplifier Q301, Q302

This two-stage amplifier has a basically flat response, and provides about 17 dB voltage gain to compensate for tone-control insertion loss. It also isolates the volume-control and tone-control circuits to eliminate mutual interference. The input signals are amplified by Q301 and Q302, and then applied to the tone control circuit.

Bias circuit

Bias voltage for Q301 is extracted from R312 in the emitter circuit of Q302 and divided by R308 and R307, and then fed back to the base of Q301 through R306.

Note that R311 in the collector circuit of Q302 works as both load resistor and negative feedback component.

Stage/Control

Tone-control circuit Q303

Function

Fig. 1-1 shows the simplified circuit of tone control incorporated with the treble and bass turnover switches.

This circuit is a modified negative-feedback type tone-control. Note that the output generated at the collector circuit of Q303 is fed back to the base circuit of Q303 through the treble and bass tone-control network.

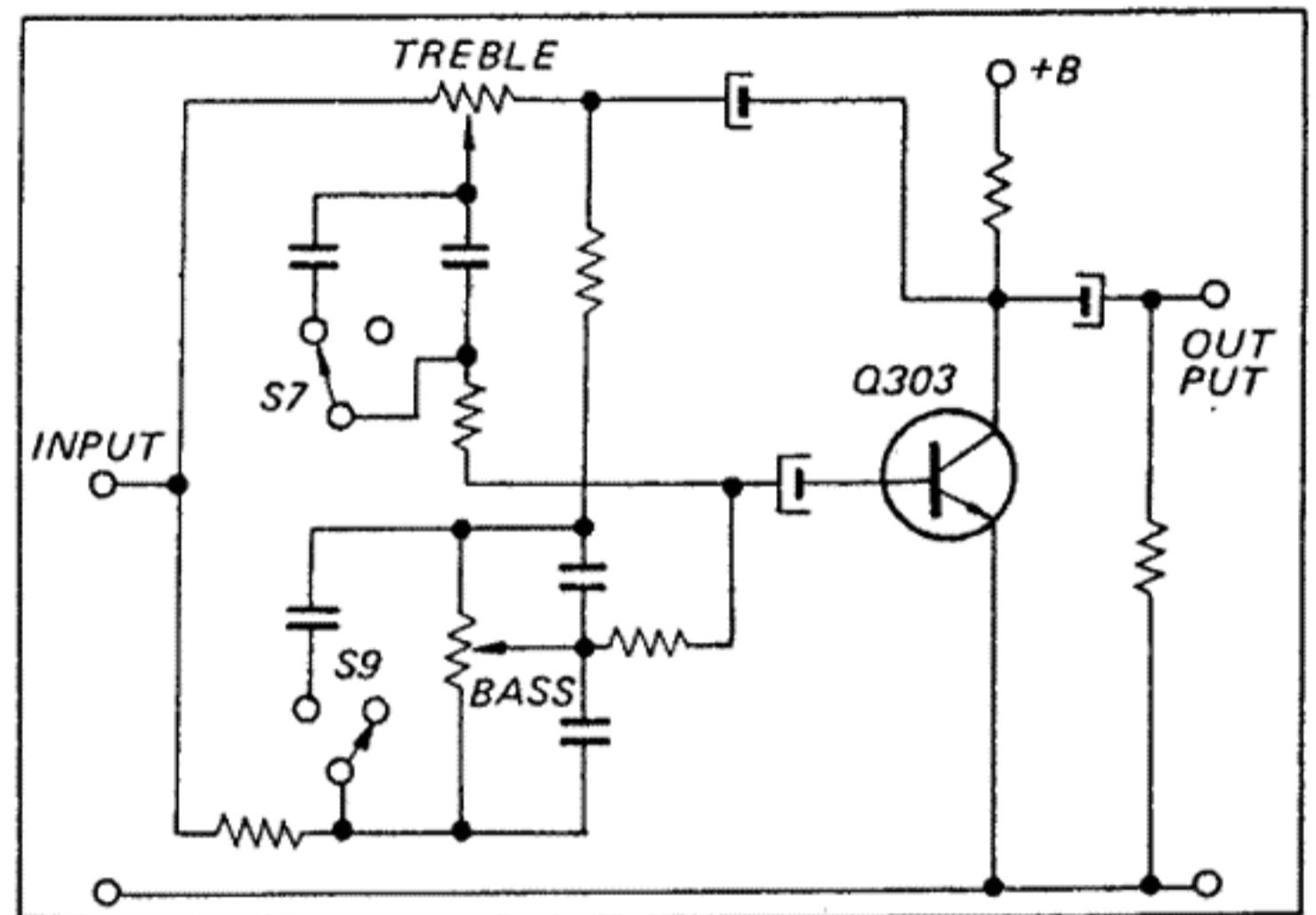

Fig. 1-1. Simplified tone control circuit

TREBLE control R317

Decreases or increases the amount of negative feedback voltage by means of R317. Each step of this control represents a change in the treble response of approximately 2 dB at the specified turnover frequencies.

TREBLE TURN-OVER FREQUENCY switch S7

S7 selects the specified turnover frequencies (2.5 kHz or 5 kHz). Refer to Fig. 1-2.

BASS control R318

Decreases or increases the amount of negative feedback voltage by means of R318. Each step of this control represents a change in the bass response of approximately 2dB at the specified turnover frequencies.

<i>Stage/Control</i>	<i>Function</i>
BASS TURNOVER FREQUENCY switch S9	S9 selects the specified turnover frequencies (500 Hz or 250 Hz). Refer to the Fig. 1-2. (tone control response).
HIGH FILTER switch S10	The high-cut filter (R322 and C317) cuts out unwanted high frequency components (5 kHz and higher) from the input signal when this switch is ON. Refer to Fig. 1-3.
LOW FILTER switch S11	The low-cut filter (C318, R324 and C319) eliminates unwanted

<i>Stage/Control</i>	<i>Function</i>
PREAMP/POWER AMP switch S12	low-frequency components (70 Hz and lower) from the input signal when this switch is ON. Refer to Fig. 1-3.
	In NORMAL, the output of the preamplifier section is fed to the power amplifier section through S12. In SEPARATE, the output of the preamplifier section is disconnected from the power amplifier's input terminal, allowing you to use the sections separately.

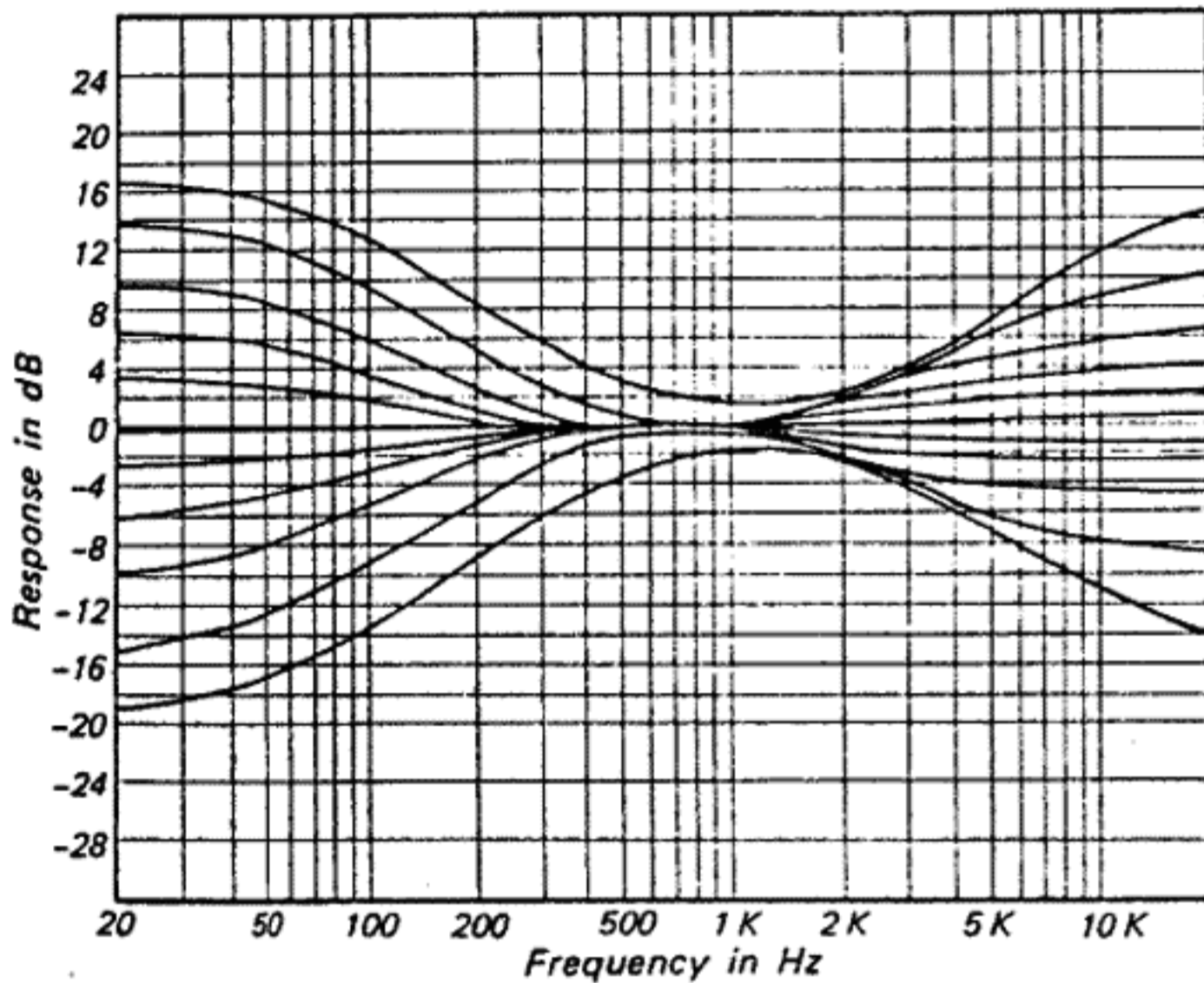

TURNOVER FREQUENCY: BASS 500 Hz
TREBLE 2.5 kHz

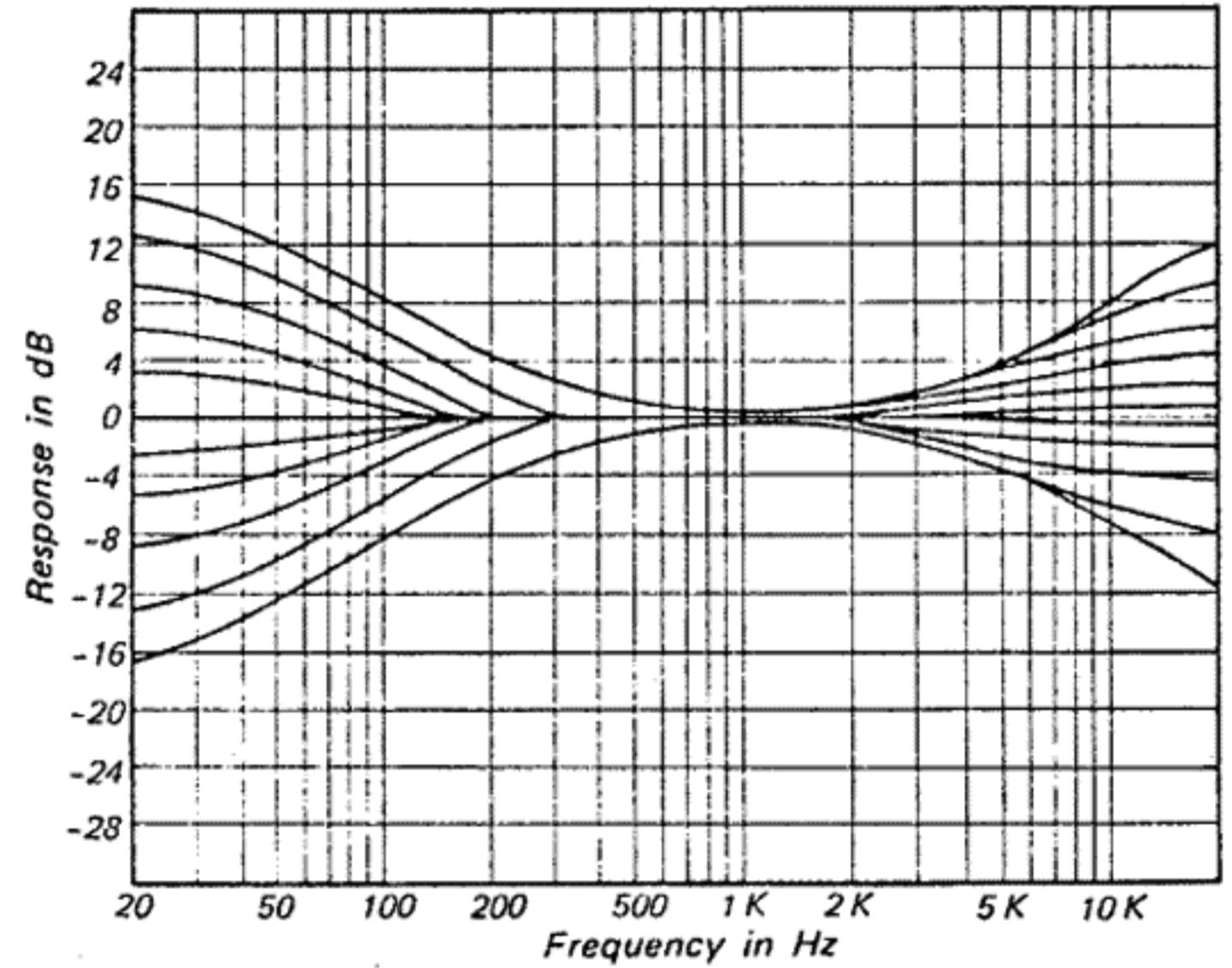

TURNOVER FREQUENCY: BASS 250 Hz
TREBLE 5 kHz

Fig. 1-2. Tone control frequency response

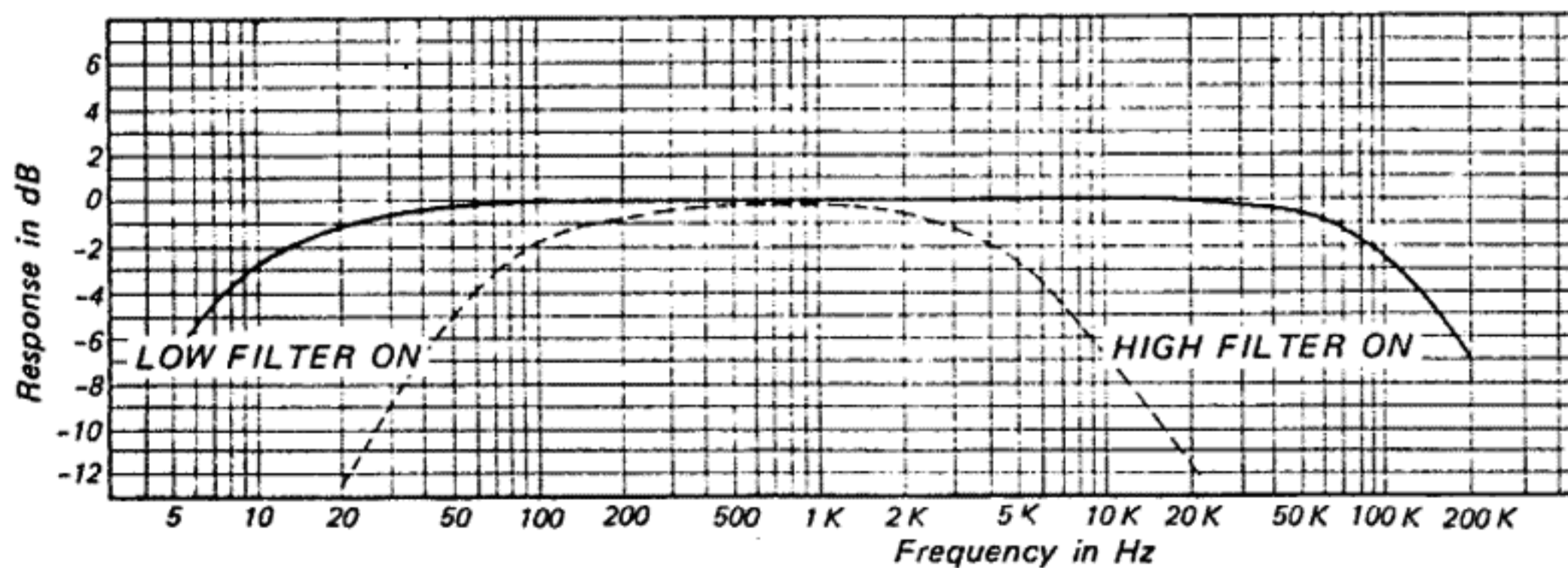

Fig. 1-3. Filter response

<i>Stage/Control</i>	<i>Function</i>	<i>Stage/Control</i>	<i>Function</i>
Power Amplifier Section			
Preamplifier Q501, Q502, Q503	Q501, Q502 and Q503 form a modified paraphase amplifier but output signal is extracted from the emitter circuit of Q502. Note that Q501 and Q502 are in a Darlington configuration. This circuit has various advantages in a direct-coupling system. One is high stability despite temperature variation and another is high input impedance without reducing the amplifier's gain. The ac output appears across load resistor R507 (R607) in the emitter circuit of Q502. A decoupling circuit formed by the emitter-base resistance of Q503, C503 and R510 is essentially a frequency-selective ac bypass circuit to reduce the amplifier's gain at very low frequencies. Common emitter-resistor R509 keeps the dc current flow constant in Q501, Q502 and Q503, thus increasing the dc stability.	Thermal dc bias compensator D501	stable operation even at high power output levels. The negative temperature coefficient of diode D501 provides thermal compensation for the idling current in the complementary and power amplifier stages. D501 (D601) is attached to the power transistor's heat sink to detect temperature increases in the power transistors.
Pre-driver Q504	Though this stage is a conventional flat amplifier, it determines the output voltage swings, because the following stages are basically emitter-followers. Note that the ac load for Q504 is the collector-emitter impedance of Q506.	Complementary (Driver) Q507, Q508	These transistors operate as emitter-followers to provide the current swings demanded of the output stages and also provide the necessary phase inversion to drive the power-output stages in push-pull. Phase inversion is performed by using PNP and NPN type transistors.
Constant current source Q506	Q506 also acts as a constant-current source, enabling effective drive for the following stages.	Power transistor Q509, Q510	The output transistor Q509 and Q510 are connected directly to a power supply of about ± 40 V. Q509 supplies power to the load during positive half cycles and Q510 operates during negative half cycles. As all the stages are directly coupled and designed to obtain zero potential at the output terminal, the large coupling capacitor at the output (which may cause power loss or distortion at low frequencies) is eliminated.
Dc bias adj. (idling current) Q505, R514	Q505 is biased into heavy conduction and operates as a small resistance providing the necessary forward bias on the two cascaded emitter-followers. R514 controls the base bias of Q505, determining its emitter-collector impedance and thereby controls the dc bias voltage for the following complementary circuit. This circuit has the advantage of	Power transistor protection circuit circuit breaker (CB-1)	To protect overloaded power transistors from destruction, a new circuit breaker which combines a bimetal switch and lamp together is employed. In the event of a short circuit at the output terminals, the excessive current heats the contact points of the bimetal switch, causing the switch open. As the lamp is connected in parallel with the bimetal switch, the current now flows through the lamp. As a result, the breaker lamp lights, and its high resistance limits the excessive

Stage/Control**Function**

current flow down to a low value, thereby protecting the power transistors. When the breaker lamp lights it will be noticed from the outside of the top cover. Note that the lamp lights only when a relatively large signal is applied while speaker terminal shorted.

Power Supply Section**Rectifier D901**

A full-wave bridge rectifier and center-tapped transformer provides positive and negative dc power supplies for the power amplifier.

Ripple filter

Q901,
R901, R903, C907
Q902
R902, R904, C908

These components reduce the ripple voltages in the dc power supply for preamplifier and driver stages of the power amplifier section to an extremely-low value. Q901 and Q902 serve as an electronic filter to supply well

Stage/Control**Function**

filtered dc of about $\pm 38V$ to the preamplifier stages in the power amplifier.

Rectifier D902

A half-wave rectifier D902 provides positive dc power for the preamplifier stages.

**Ripple filter
Q903, R907, C919**

These components reduce the ripple voltages in the dc power supply for preamplifier stages to an extremely low value. Q903 serves as an electronic filter to supply well-filtered dc of about 43 V and 30 V to the preamplifier stages.

**Power switch
S15-1
S15-2**

Note that the power switch S15 has two functions. One is a conventional power line ON-OFF function, the other is muting operation when power switch is turned OFF. Proper muting is performed by discharging filter capacitors C913 and C914 quickly through R910 and S15-2.

1-3. BLOCK DIAGRAM

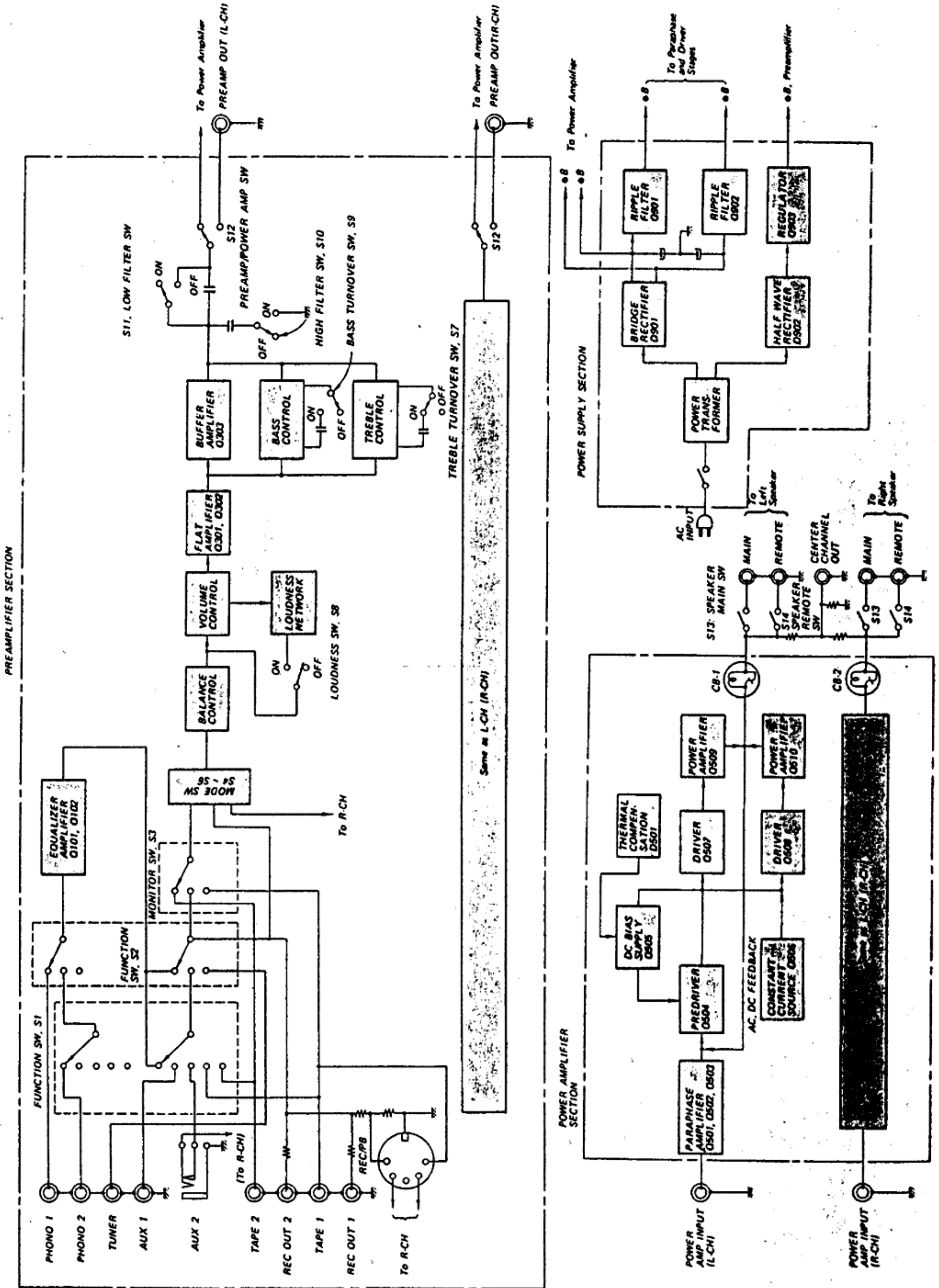

14. LEVEL DIAGRAM

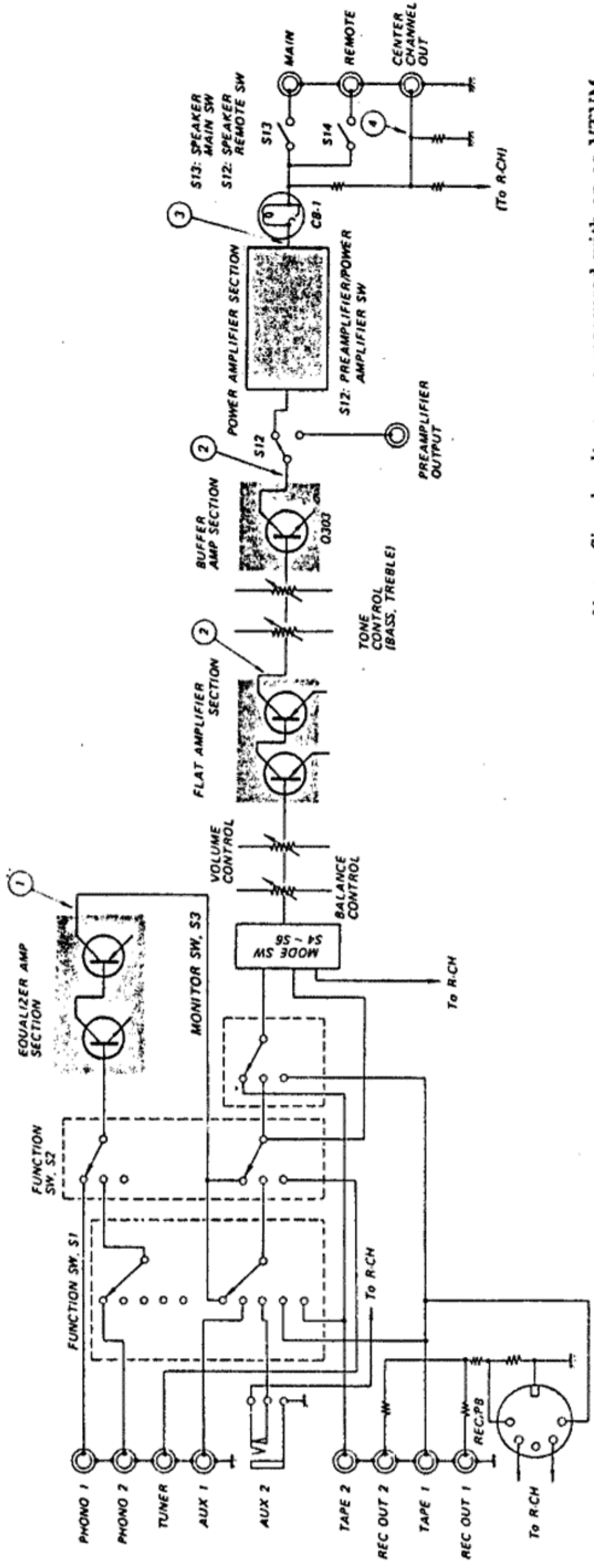
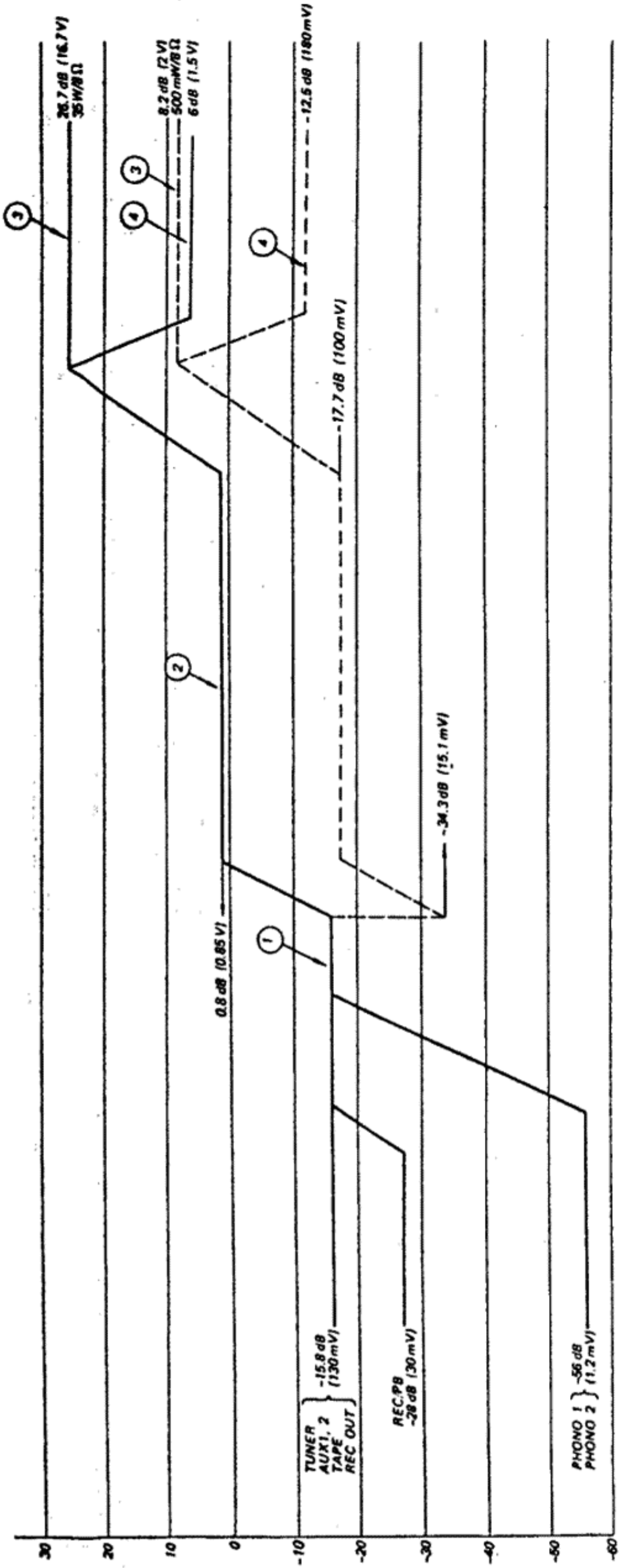

Note: Signal voltages are measured with an ac VTVM and expressed in dB referred to 0.775 V, 1 kHz.

SECTION 2

DISASSEMBLY AND REPLACEMENT PROCEDURES

WARNING

Unplug the ac power cord before starting any disassembly or replacement procedures.

2-1. TOOLS REQUIRED

The following tools are required to perform disassembly and replacement procedures on the TA-1140.

1. Screwdriver, Phillips-head
2. Screwdriver, 3mm (1/8") blade
3. Pliers, long-nose
4. Diagonal cutters
5. Wrench, adjustable
6. Tweezers
7. Electric drill
8. Drill bits
9. Prick punch
10. Hammer, ball-peen
11. Soldering iron, 40 to 50 watts
12. Solder, rosin core
13. Cement solvent
14. Cement, contact
15. Silicone grease

2-2. HARDWARE IDENTIFICATION GUIDE

The following chart will help you to decipher the hardware codes given in this service manual.

Note: All screws in this set are manufactured to the specifications of the International Organization for Standardization (ISO). This means that the new and old screws are not interchangeable because ISO screws have a different number of thread per mm compared to the old ones. The ISO screws have an identification mark on their heads as shown in Fig. 2-1.

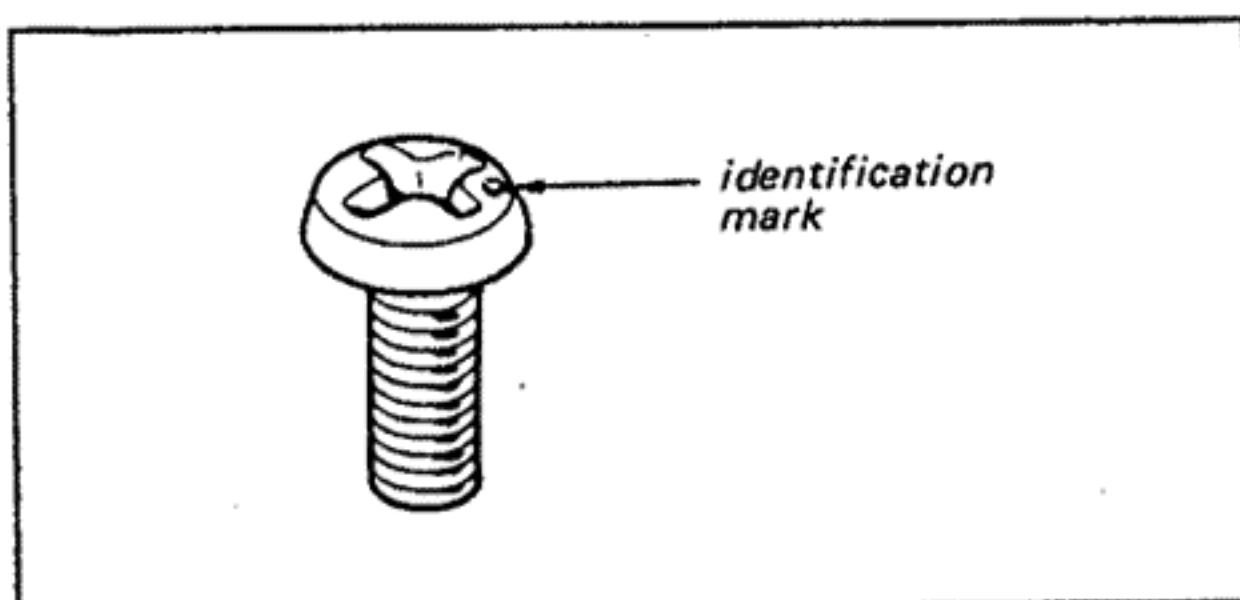
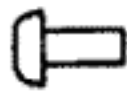
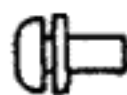
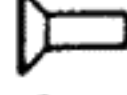

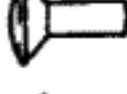
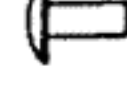
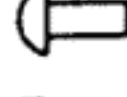
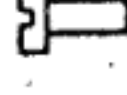
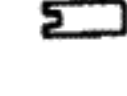
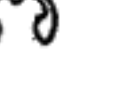

Fig. 2-1. ISO screw

— Hardware Nomenclature —

P	Pan Head Screw	⊕	
PS	Pan Head Screw with Spring Washer	⊕	
K	Flat Countersunk Head Screw	⊕	
B	Binding Head Screw	⊕	
RK	Oval Countersunk Head Screw	⊕	
T	Truss Head Screw	⊕	
R	Round Head Screw	⊕	
F	Flat Fillister Head Screw	⊕	
SC	Set Screw	⊕	
E	Retaining Ring (E Washer)	⊕	
	W	Washer	
	SW	Spring Washer	
	LW	Lock Washer	
	N	Nut	

— Example —

⊕ P 3x10

— Type of Slot

— Length in mm (L)

— Diameter in mm (D)

— Type of Head

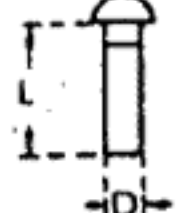
2-3. TOP COVER AND FRONT PANEL REMOVAL

1. Remove the two machine screws at each side of the case, and lift off the top cover.
2. Remove all control knobs and levers except push buttons.
The knobs can be removed by loosening the slotted set screws and pulling the knobs straight out.
The levers are simply pulled off.
3. Remove the three screws (⊕ PSW 4x6) behind the top edge of the front subchassis as shown in Fig. 2-2.
4. Remove the three self-tapping screws (⊕ B 3x6) at the front bottom of the chassis as shown in Fig. 2-3. This frees the front panel.

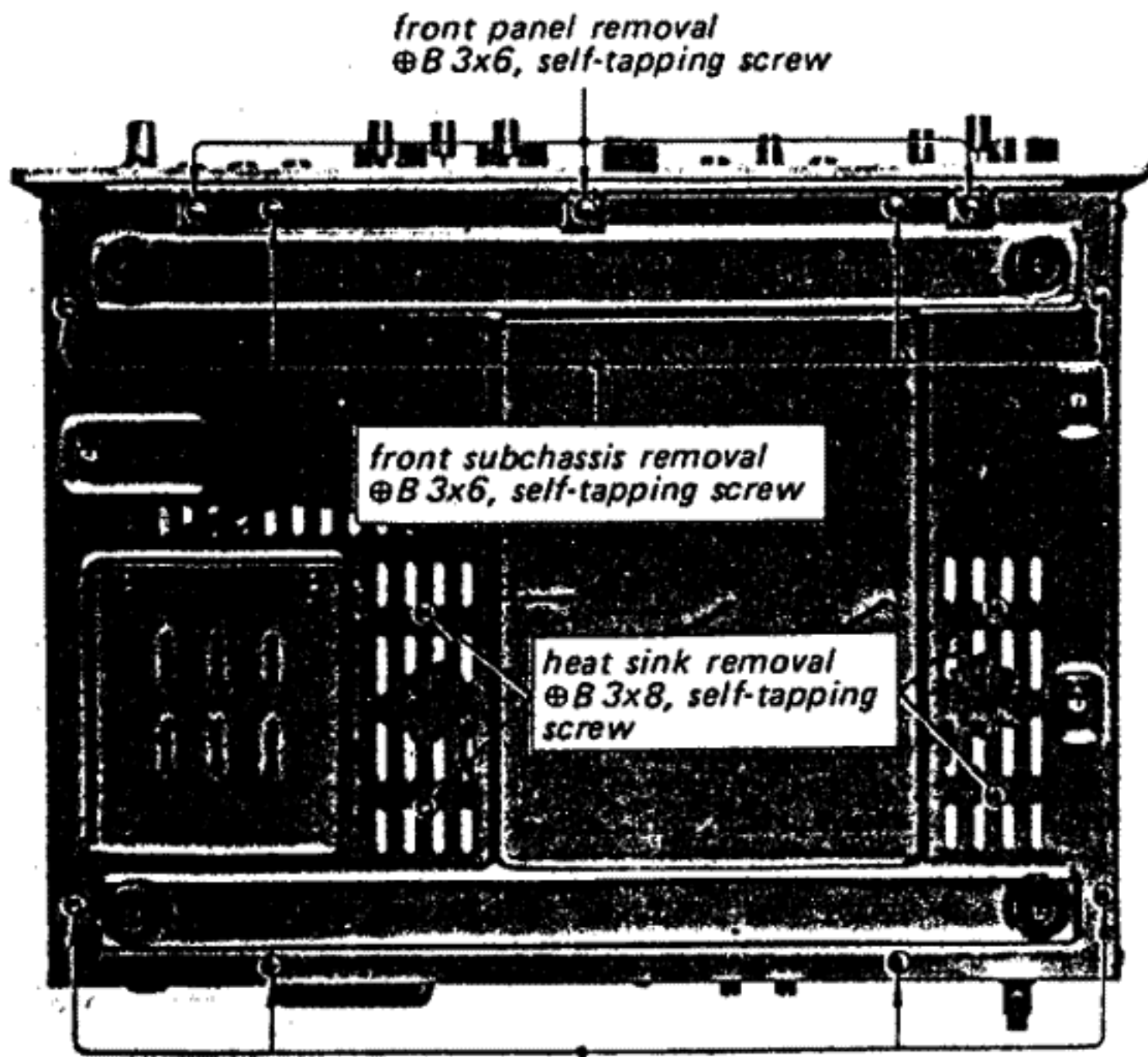

Fig. 2-3. Bottom view

2-4. FRONT SUBCHASSIS REMOVAL

The front subchassis is the vertical member on which all the controls, switches and pilot lamp are attached.

1. Remove the top cover and front panel as described in Procedure 2-3.
2. Remove the two self-tapping screws (⊕ B 3x6) at each side of the chassis (see Fig. 2-4) and four self-tapping screws (⊕ B 3x6) at the front bottom of the chassis as shown in Fig. 2-3. This frees front subchassis.

2-5. REAR PANEL REMOVAL

1. Remove the top cover as described in Procedure 2-3.
2. Remove the two self-tapping screws (⊕ B 3x6) at each side of the chassis (see Fig. 2-4) and four self-tapping screws (⊕ B 3x6) at the rear bottom of the chassis as shown in Fig. 2-3. This frees rear panel.

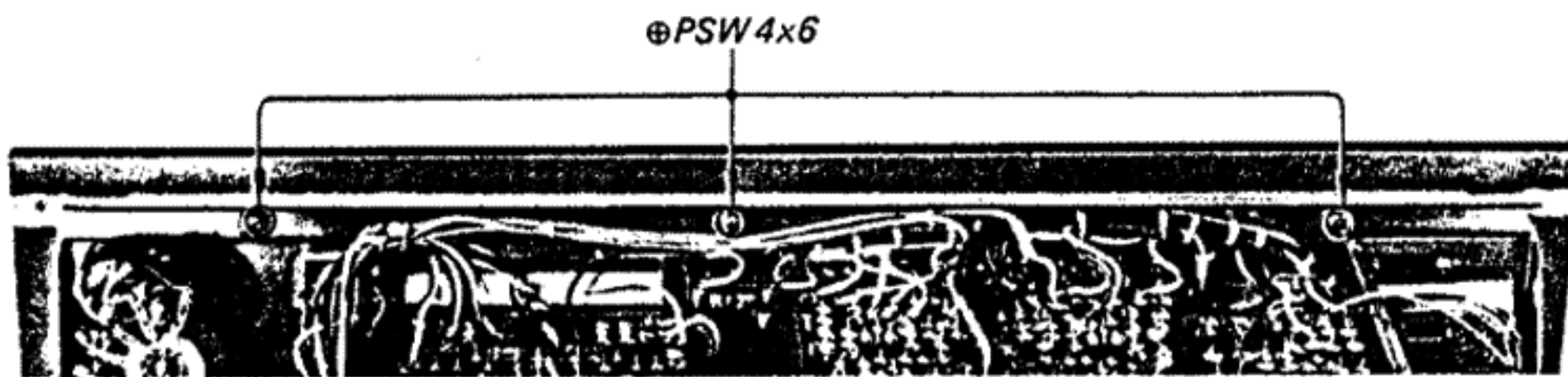

Fig. 2-2. Front panel removal

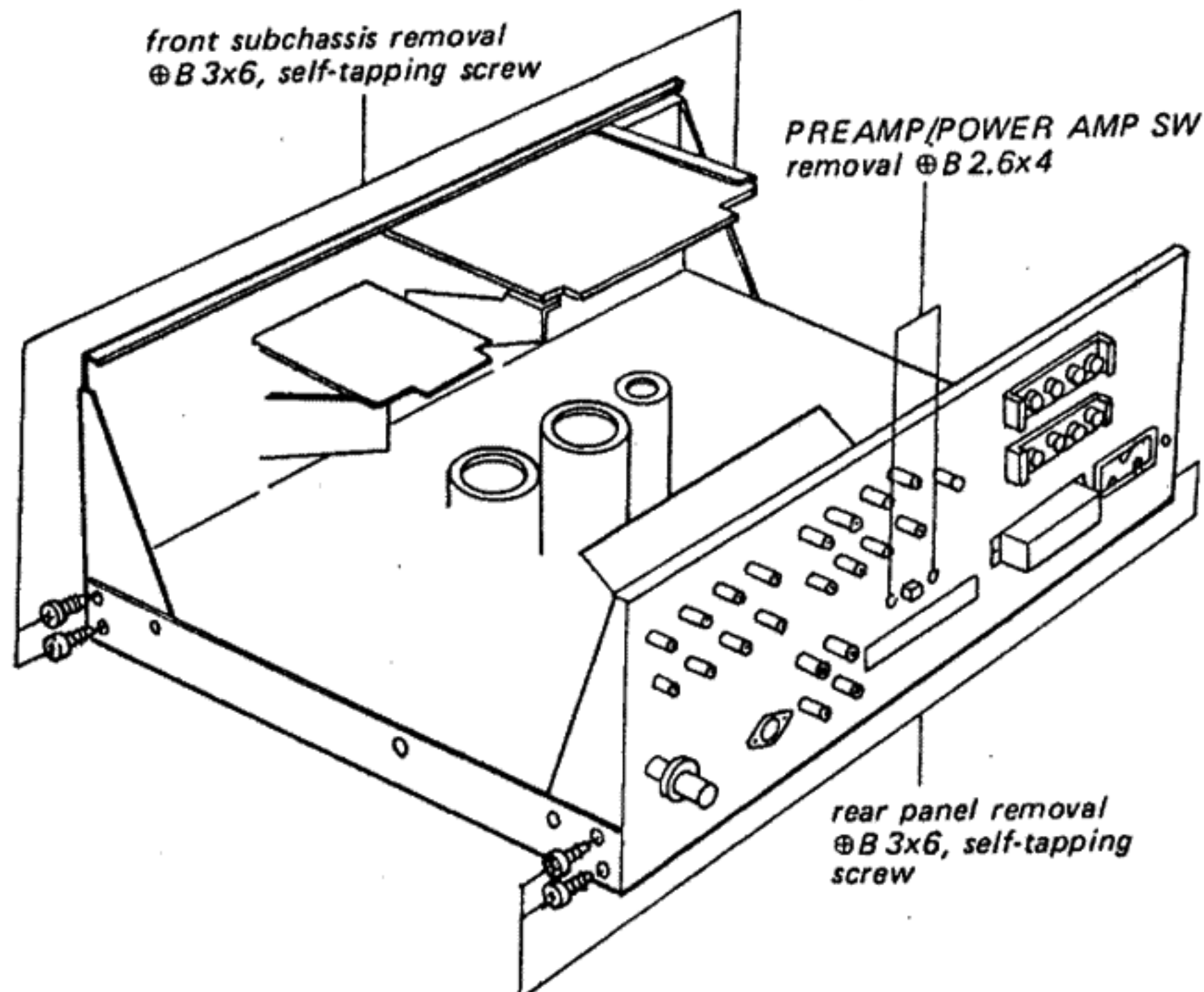

Fig. 2-4. Front subchassis removal

2-6. CONTROL AND SWITCH REPLACEMENT

Prepare for replacing any of the controls or switches by removing the front panel and front subchassis or rear panel as described in Procedure 2-3, 2-4 and 2-5.

POWER, FUNCTION-2 MONITOR, TURNOVER FREQ. and LOUDNESS Switches

1. Remove the two screws securing switches to the front subchassis as shown in Fig. 2-5.
2. Unsolder the lead wires from the defective switch, and then install the replacement switch.

TONE Controls

1. Remove the hex nuts that secure BASS and TREBLE controls to the front subchassis as shown in Fig. 2-5.
2. Remove the two screws (⊕PSW 3x6) securing the Preamplifier/Power Supply circuit board to its mounting bracket as shown in Fig. 2-6.
3. Carefully remove them along with the PCB.
4. Cut each lug of the defective control on the board to remove the part.
5. Unsolder and remove the clipped lugs, and then clean out the holes in the circuit board.

6. Install the replacement control.

FUNCTION-1 Switch

1. Remove the hex nut that secures FUNCTION-1 switch to the front subchassis as shown in Fig. 2-5.
2. Unsolder the lead wires from the defective switch, and then install the replacement switch.

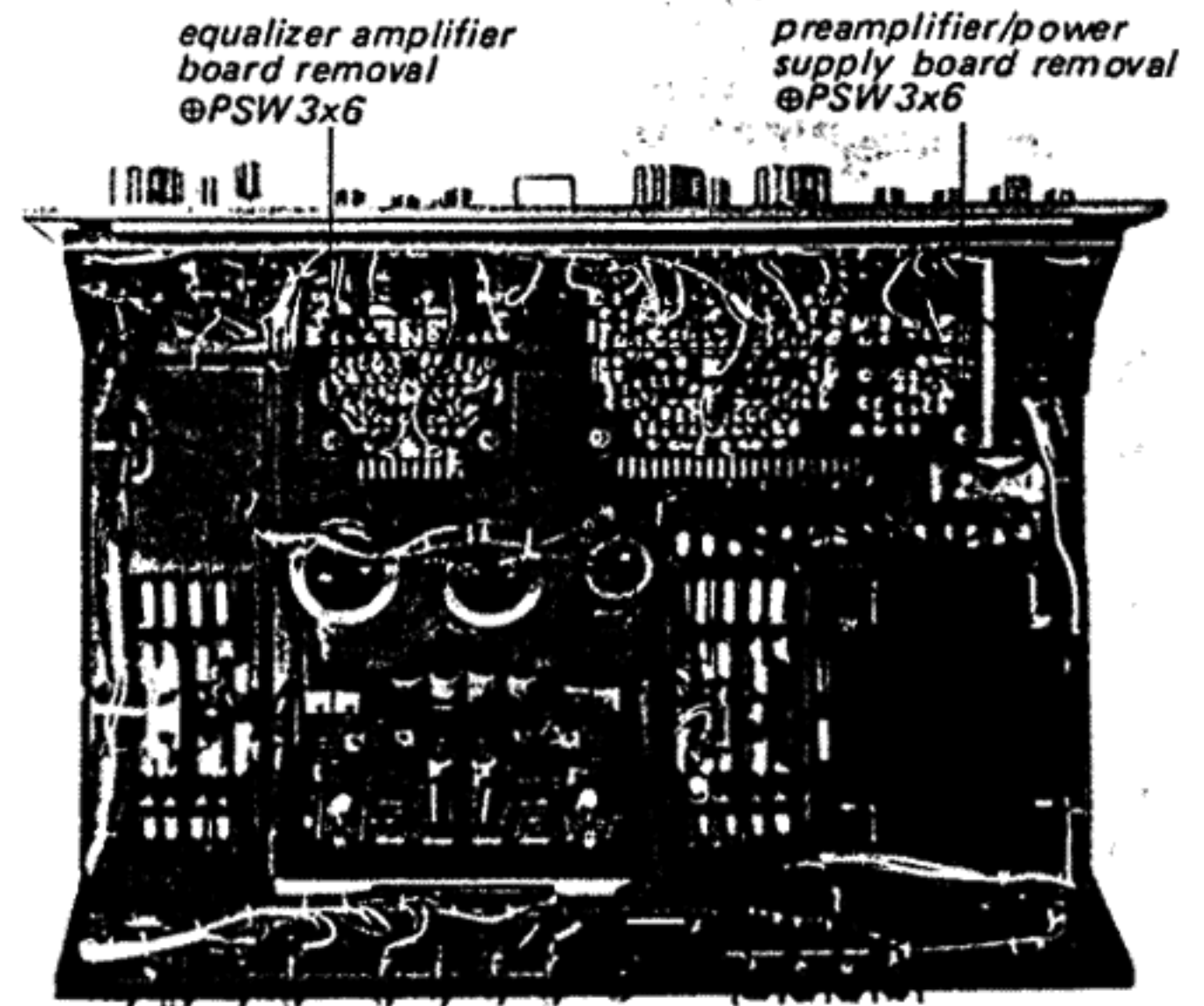

Fig. 2-6. PCB removal

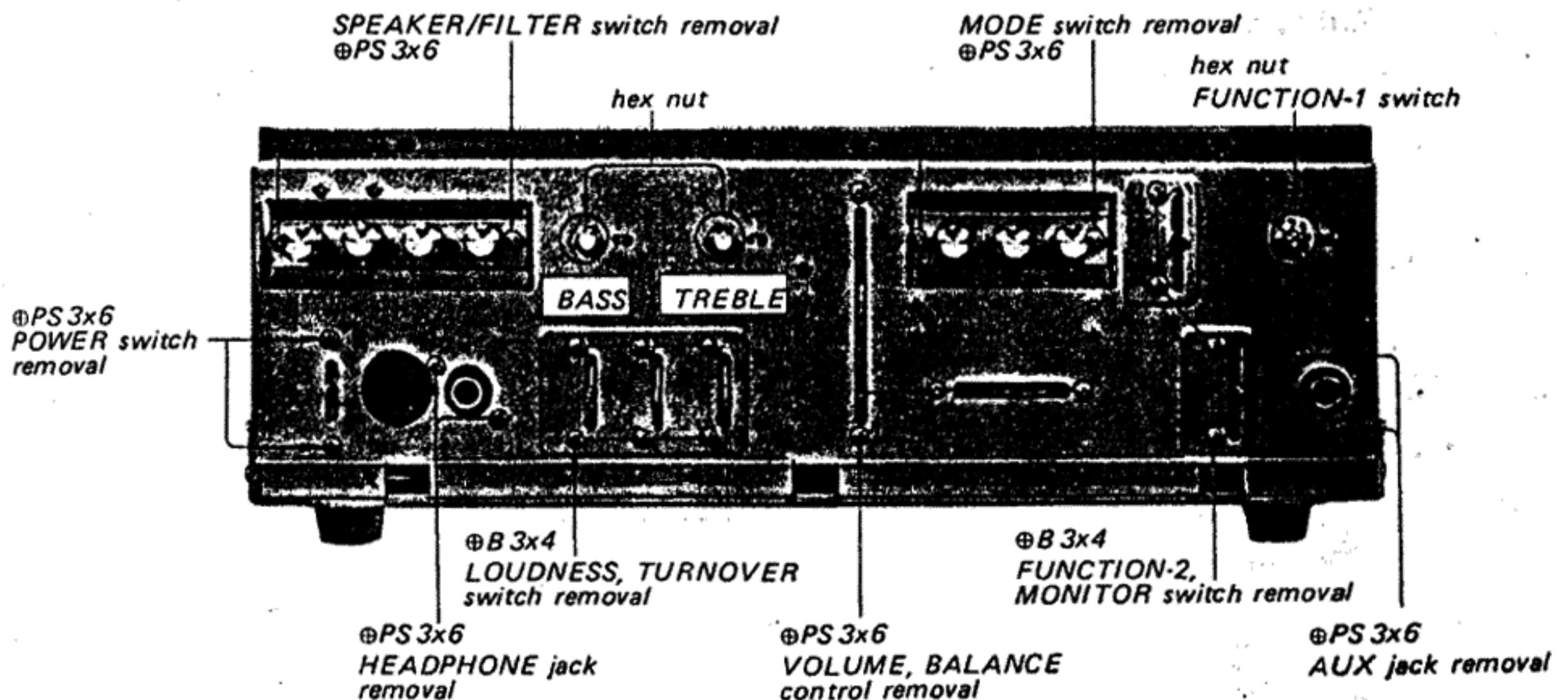

Fig. 2-5. Control and switch replacement

SPEAKER/FILTER Switch

Note: As SPEAKER and FILTER switches are combined with one bracket, whole combination switch should be replaced even one of them becomes defective.

1. Remove the Preamplifier/Power Supply circuit board as previously described.
2. Remove the two screws (⊕ PS 3x6) securing the combination switch to the front subchassis as shown in Fig. 2-5.
3. With a soldering-iron having a solder-sucking tip, clean the solder from each lug of the switches and the printed circuit board. This frees the combination switch.
4. Install the replacement combination switch.

MODE Switch

Note: Three switches are combined with one bracket so whole combination switch should be replaced even one of them becomes defective.

1. Remove the two screws (⊕ PSW 3x6) securing the Equalizer Amplifier Board to its mounting bracket as shown in Fig. 2-6.
2. Remove the two screws (⊕ PS 3x6) securing the combination switch to the front subchassis as shown in Fig. 2-5.
3. With a soldering-iron having a solder-sucking tip, clean the solder from each lug of the switches, and the printed circuit board.
4. Install the replacement switch.

VOLUME Control

1. Remove the two screws (⊕ PS 3x6) securing the control to the front subchassis as shown in Fig. 2-5.
2. Carefully remove it along with Volume/Loudness Control Board.
3. With a soldering iron having a solder-sucking tip, clean the solder from each lug of the

defective control and the printed circuit board.

4. Install the replacement control.

HEADPHONE, AUX Jacks and BALANCE Control

1. Remove the two screws (⊕ PS 3x6) securing the control or jack escutcheon to the front subchassis as shown in Fig. 2-5.
2. Unsolder the lead wires from the defective control or jack and then install the new one.

PREAMP/POWER AMP Switch

1. Remove the rear panel as described in Procedure 2-5.
2. Remove the two screws (⊕ B 2.6x4) securing the switch to the rear panel as shown in Fig. 2-4.
3. Unsolder the lead wires from the defective switch, and then install the replacement switch.

2-7. PRINTED CIRCUIT BOARD REMOVAL

Prepare for removing any of the printed circuit boards, except Power Amplifier Board, by removing front panel as described in Procedure 2-3.

Equalizer Amplifier Board

1. Refer to the MODE switch replacement procedure as described in Procedure 2-6.

Preamplifier/Power Supply Board

1. Refer to the TONE control replacement procedure as described in Procedure 2-6.

Speaker Switch Board

1. Refer to the SPEAKER/FILTER switch replacement procedure as described in Procedure 2-6.

Volume/Loudness Control Board

1. Refer to the VOLUME control replacement procedures as described in Procedure 2-6.

2-8. POWER TRANSISTOR REPLACEMENT

1. Remove the top cover as described in Procedure 2-3.
2. Remove the two self-tapping screws ($\text{B } 3 \times 8$) securing the heat sink to the chassis at the bottom as shown in Fig. 2-3.
3. Remove the two screws ($\text{B } 3 \times 12$) securing the power transistor to the heat sink with its socket as shown in Fig. 2-7.

Remove the defective power transistor, and then install the replacement power transistor.

Note: When replacing the power transistor, apply a coating of a heat-transferring grease to both sides of the insulating mica washer. Any excess grease squeezed out when the mounting bolts are tightened should be wiped off with a clean cloth.

This prevents it from accumulating conductive dust particles that might eventually cause a short.

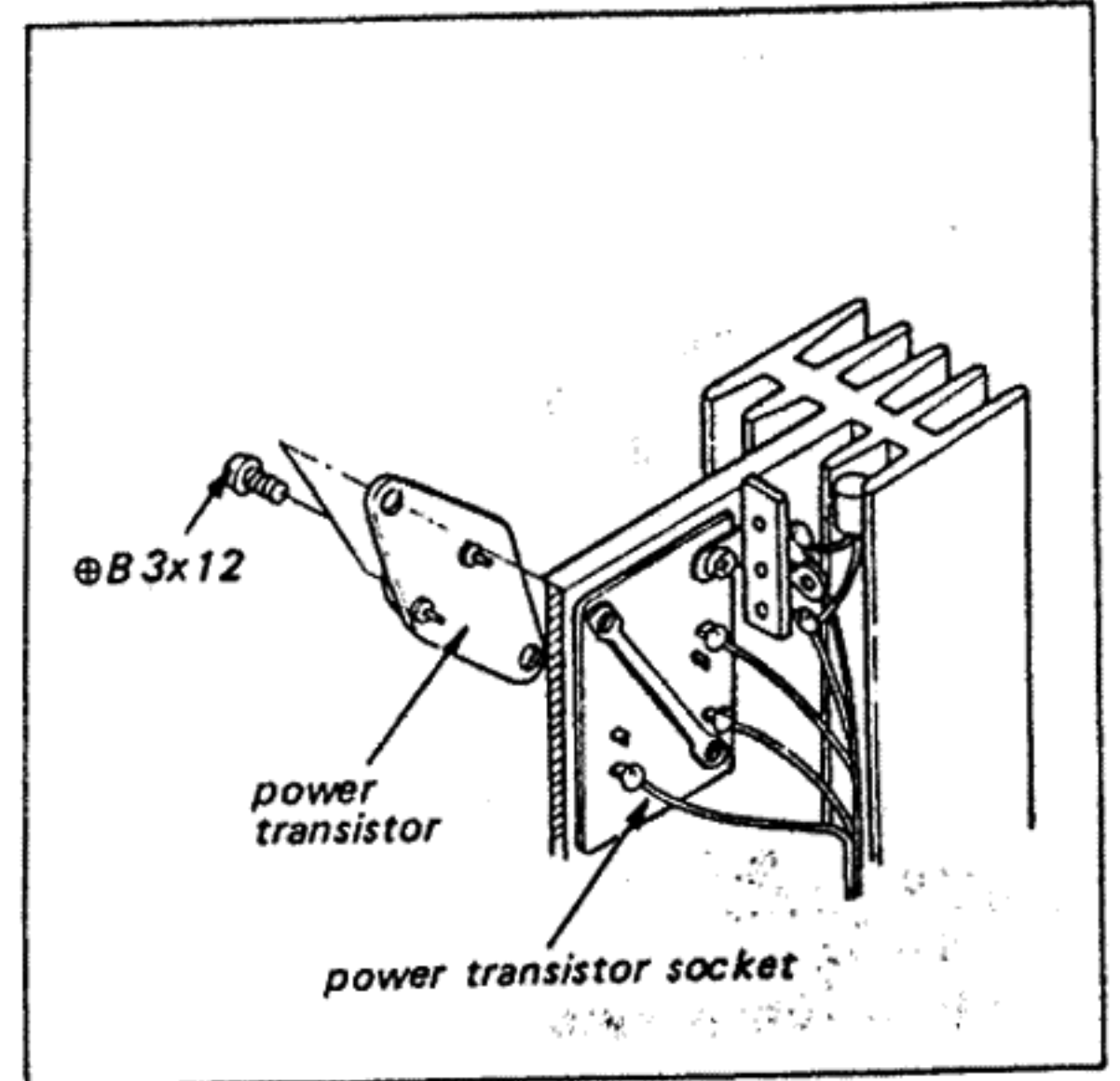
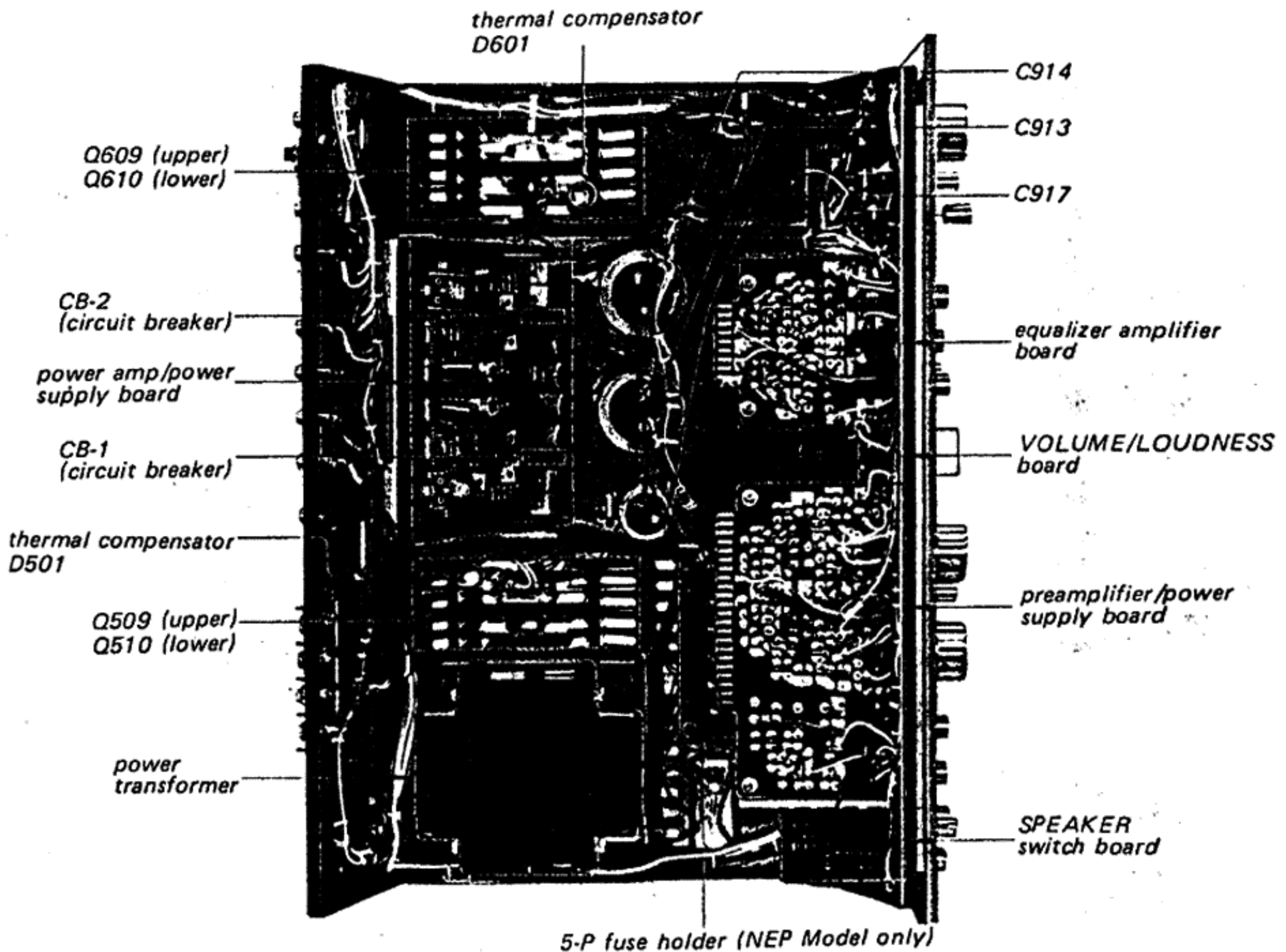

Fig. 2-7. Power transistor replacement

2-9. CHASSIS LAYOUT



SECTION 3 ADJUSTMENTS

3-1. DC BIAS ADJUSTMENT

Note: There are usually two adjustments to be made in the power amplifier. One is dc-bias adjustment and the other is dc-balance adjustment or ac-balance adjustment. These adjustments should be alternately repeated two or three times after replacing any of the power transistors until best operation is obtained. In this case, only the dc-bias adjustment is described as the newly developed circuit made it possible to omit dc-balance adjustment.

CAUTION

To avoid accidental power transistor damage, increase the ac line voltage gradually, using a variable transformer, while measuring the voltage across test points as shown in Fig. 3-1. Check to see that the reading does not exceed 50 mV. If it does, turn off the power as soon as possible, then check and repair the trouble in the power amplifier board.

Test Equipment Required

1. Dc millivoltmeter
Capable of measuring dc voltage of 100mV or less.

2. Variable transformer
3. Screwdriver with 3mm (1/8") blade.

Preparation

1. Remove the top cover as described in Procedure 2-3.
2. Connect the dc millivoltmeter across the test terminal posts as shown in Fig. 3-1.

Procedure

1. Apply a drop of cement solvent to the semi-fixed resistors on the power amplifier board, and then set the semi-fixed resistors (See Fig. 3-1) on the power amplifier board as follows:
R514(L-CH, dc-bias) fully counterclockwise
R614(R-CH, dc-bias) fully counterclockwise
2. Set the variable transformer for minimum output.
3. Turn the power switch to ON, and then increase the line voltage up to the rated value.
4. Adjust R514 and R614 to obtain a 50 mV reading on the meter.

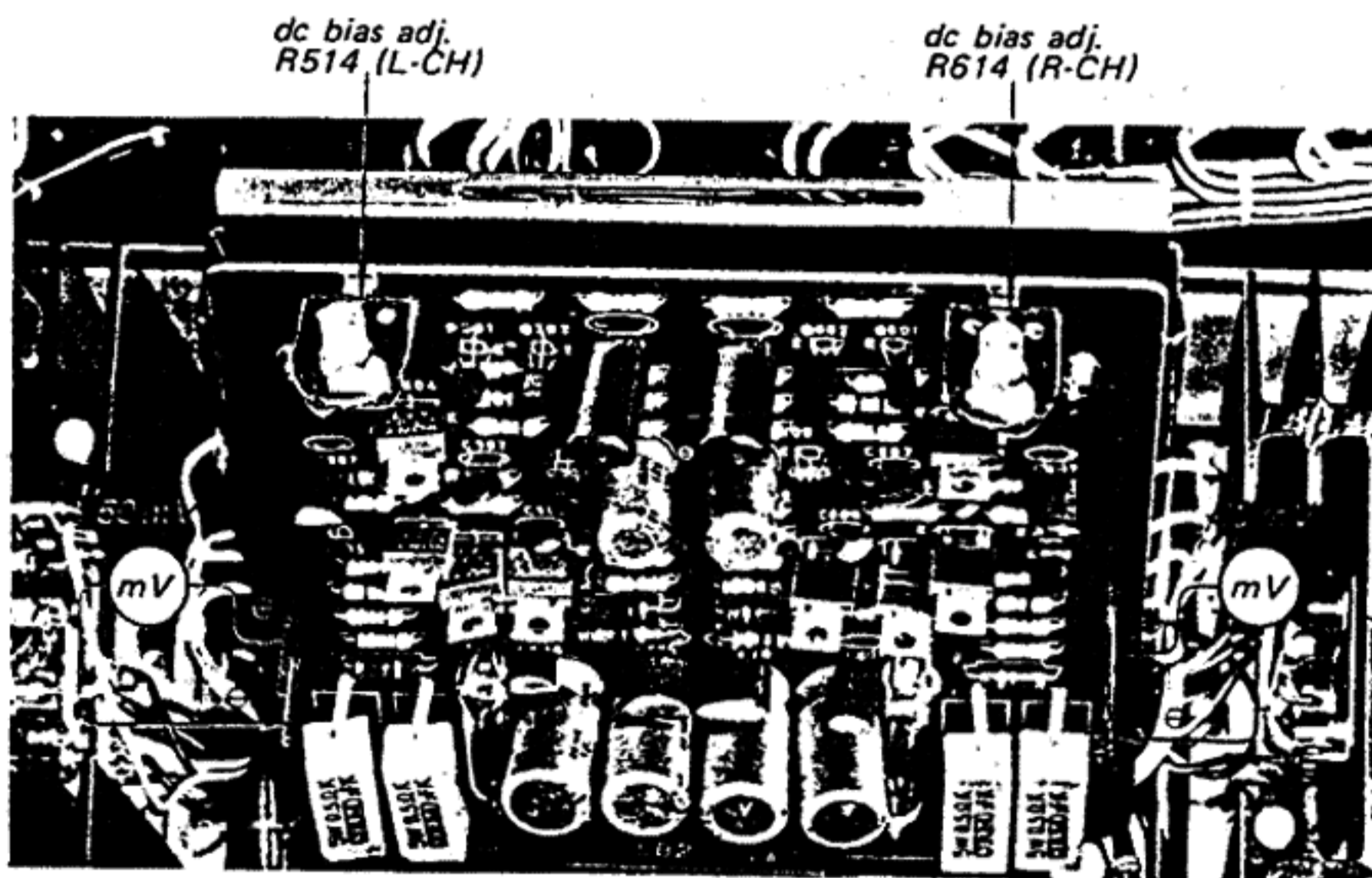


Fig. 3-1. Dc millivoltmeter connection and parts location

SECTION 4 DIAGRAMS

4-1 SCHEMATIC DIAGRAM — Preamplifier Section —



Ref. No.	Description	Position	Ref. No.	Description	Position
S1	FUNCTION(1) SW (PHONO 2-AUX 1-AUX 2-TAPE 1-2-TAPE 2-1)	PHONO 2	S8	LOUDNESS SW (ON-OFF)	ON
S2	FUNCTION(2) SW (TUNER-FUNCTION(1)-PHONO 1)	FUNCTION(1)	S9	BASS TURNOVER SW (500 Hz-250 Hz)	500 Hz
S3	MONITOR SW (TAPE 2-SOURCE-TAPE 1)	SOURCE	S10	HIGH FILTER SW (OFF-ON)	OFF
S4~S6	MODE SW (REVERSE-STEREO-L+R)	STEREO	S11	LOW FILTER SW (OFF-ON)	OFF
S7	TREBLE TURNOVER (2.5 kHz-5 kHz)	2.5 kHz	S12	PREAMP/POWER AMP SW (NORMAL-SEPARATE)	NORMAL

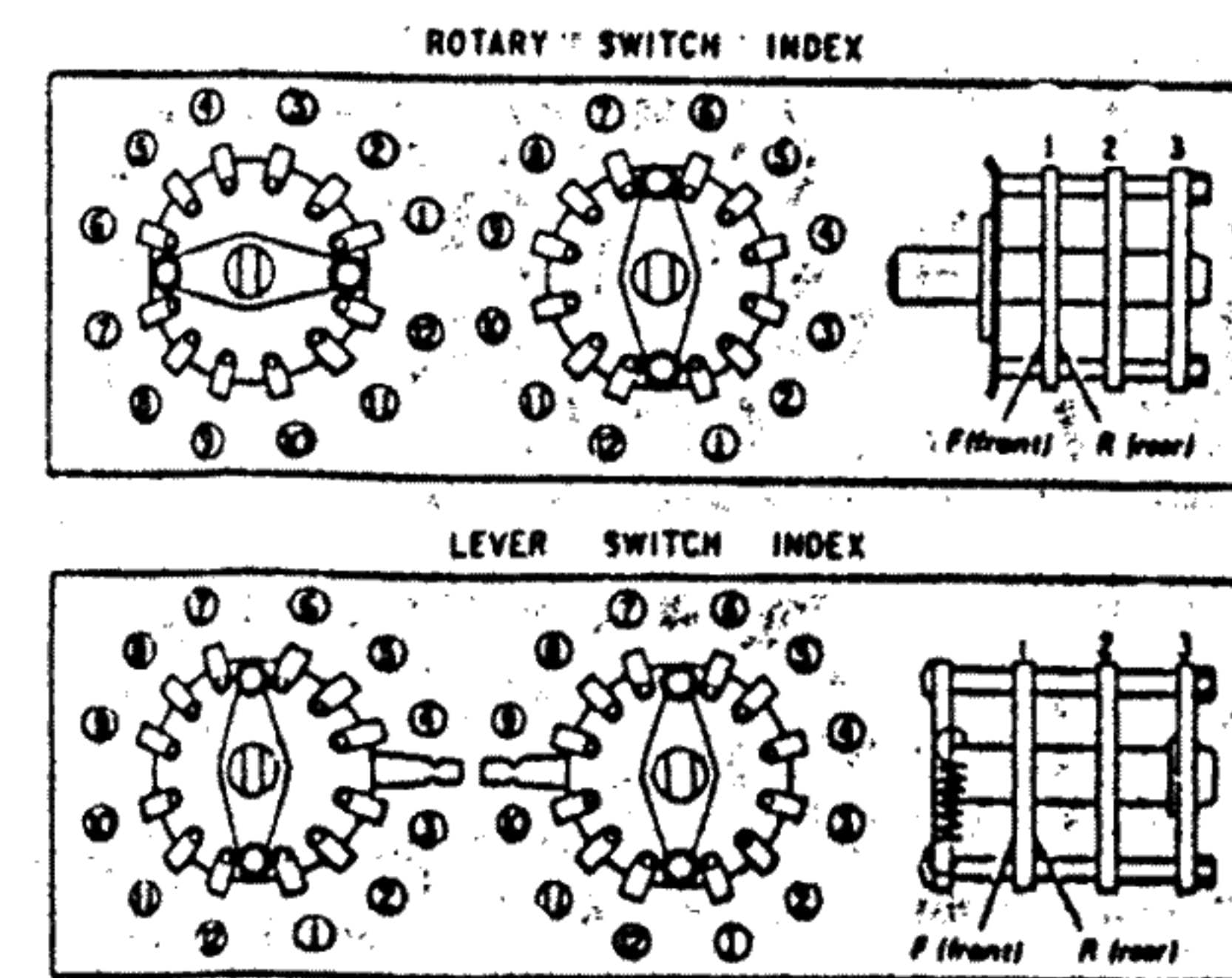

2SC632A
2SA705

Note:

All resistance values are in ohms; k = 1,000, M = 1,000 k.
All capacitance values are in μF except as indicated with p, which means μF .
All voltages represent an average value and should hold within $\pm 20\%$.
All voltages are dc measured with a VOM which has an input impedance of 20k ohms/volt. No signal in.

SONY
TA-1140

© 1971

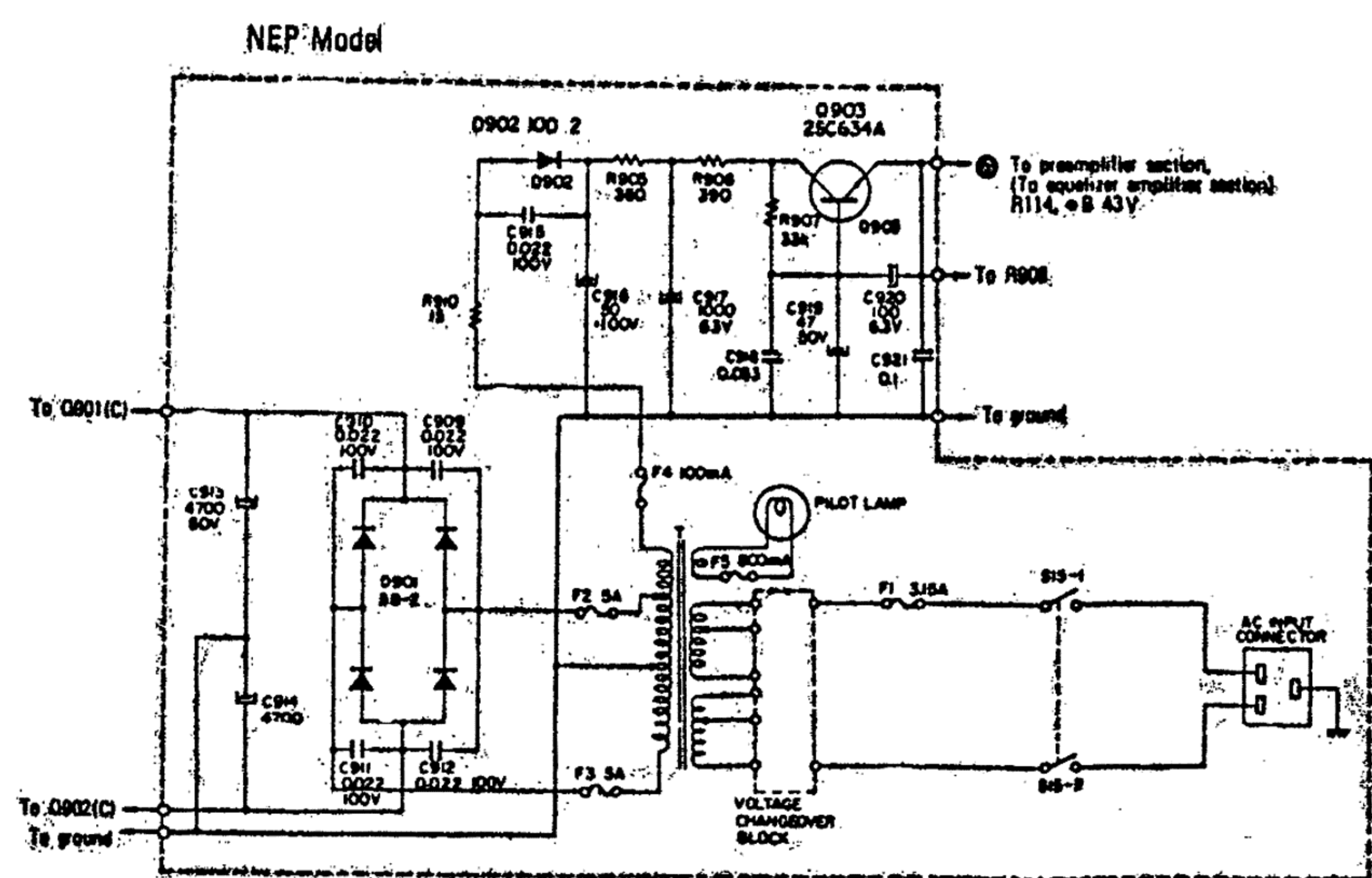
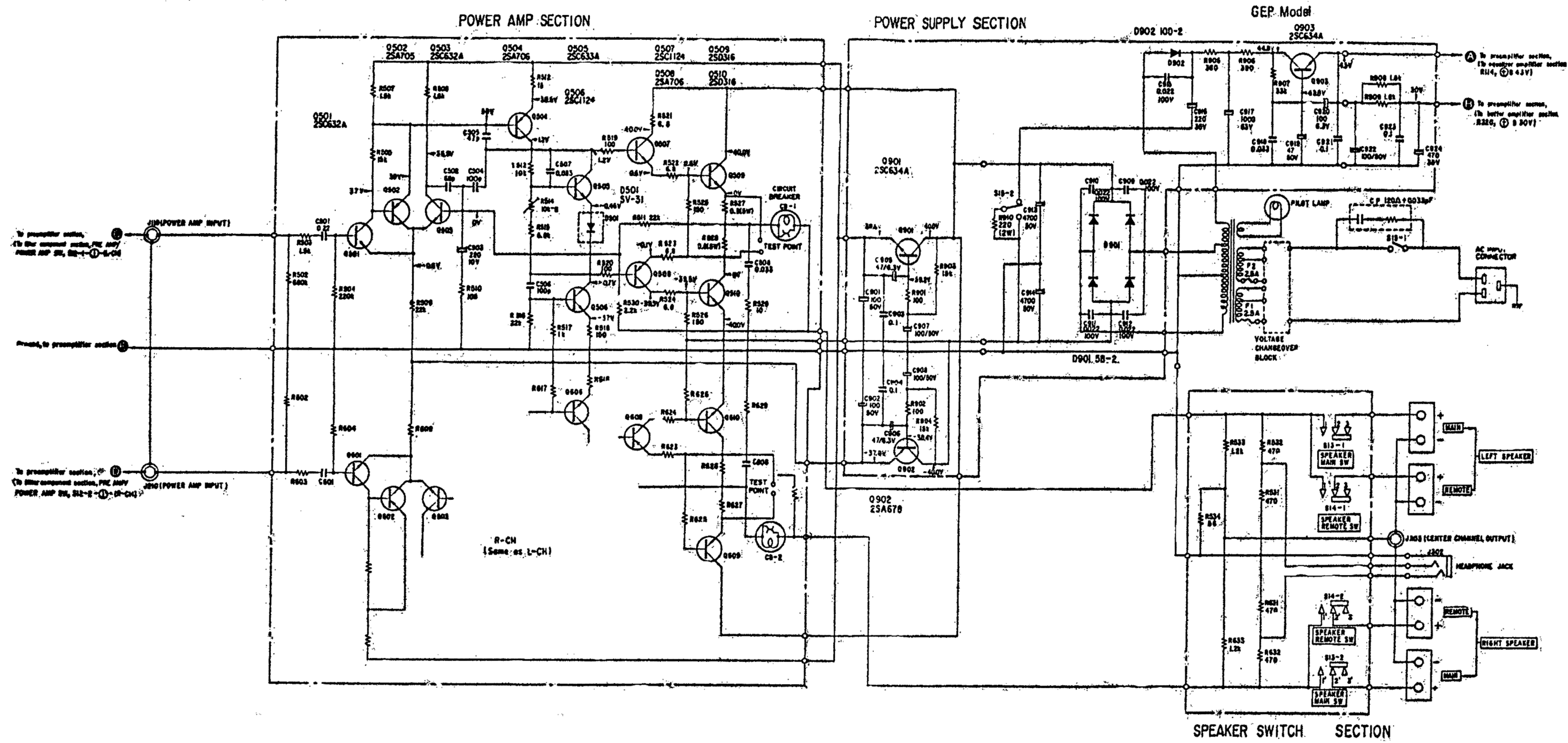

Ref. No.	Description	Position
S13	SPEAKER MAIN SW (ON-OFF)	OFF
S14	SPEAKER REMOTE SW (ON-OFF)	OFF
S15	POWER SW (ON-OFF)	OFF

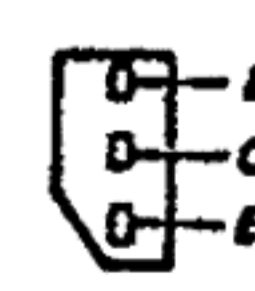

2SA705
2SA678
2SC632A
2SC633A
2SC634A

2SC1124
2SA706

2SD318

Note:

All resistance values are in ohms. k = 1,000, M = 1,000 k.
 All capacitance values are in μ F except as indicated with p, which means μ F.
 All voltages represent an average value and should hold within $\pm 20\%$.
 All voltages are dc measured with a VOM which has an input impedance of 20k ohms/volt. No signal in.

4-3. MOUNTING DIAGRAM – Volume/Loudness Control Board –
 – Conductor Side –

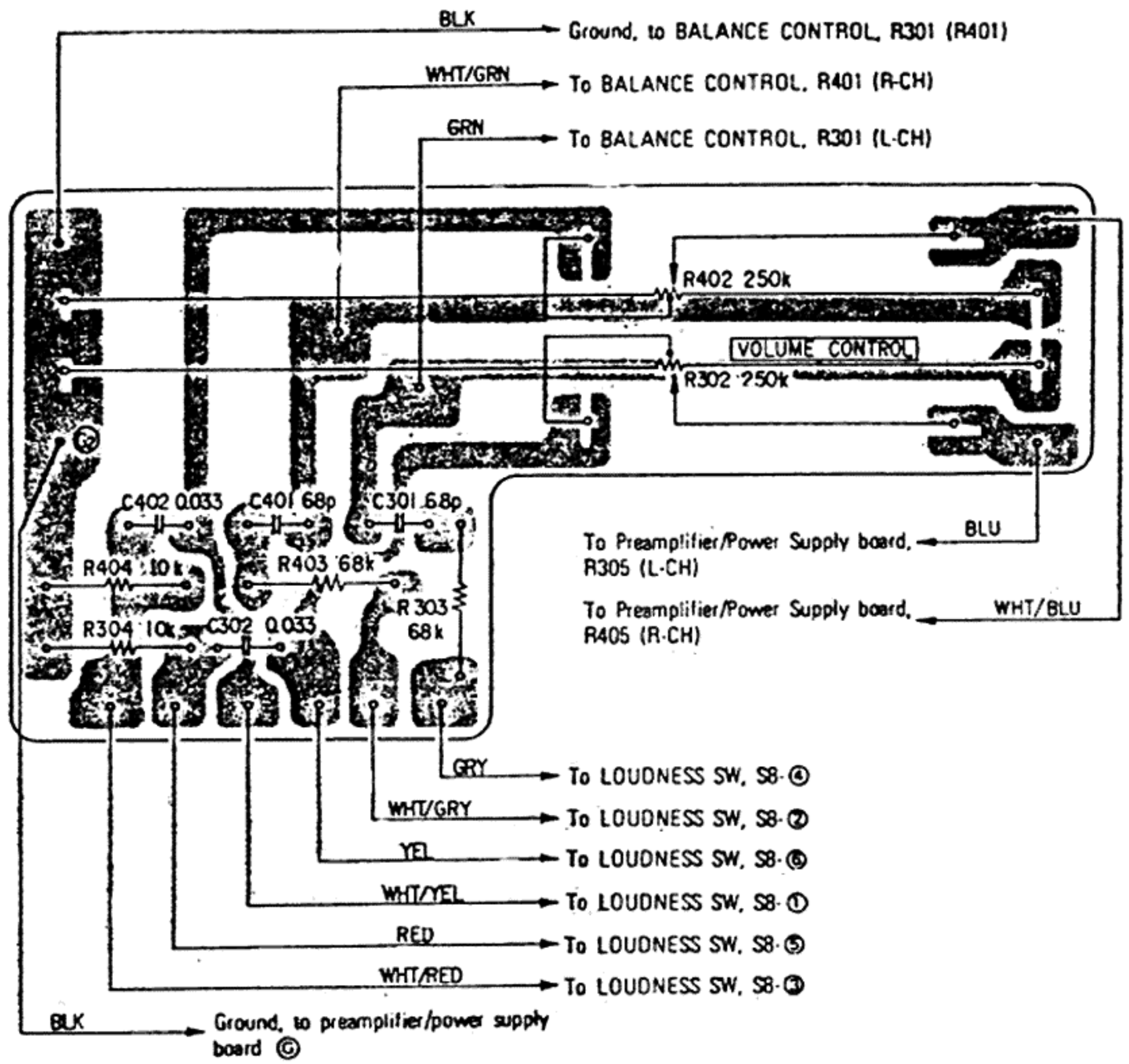

– Component Side –

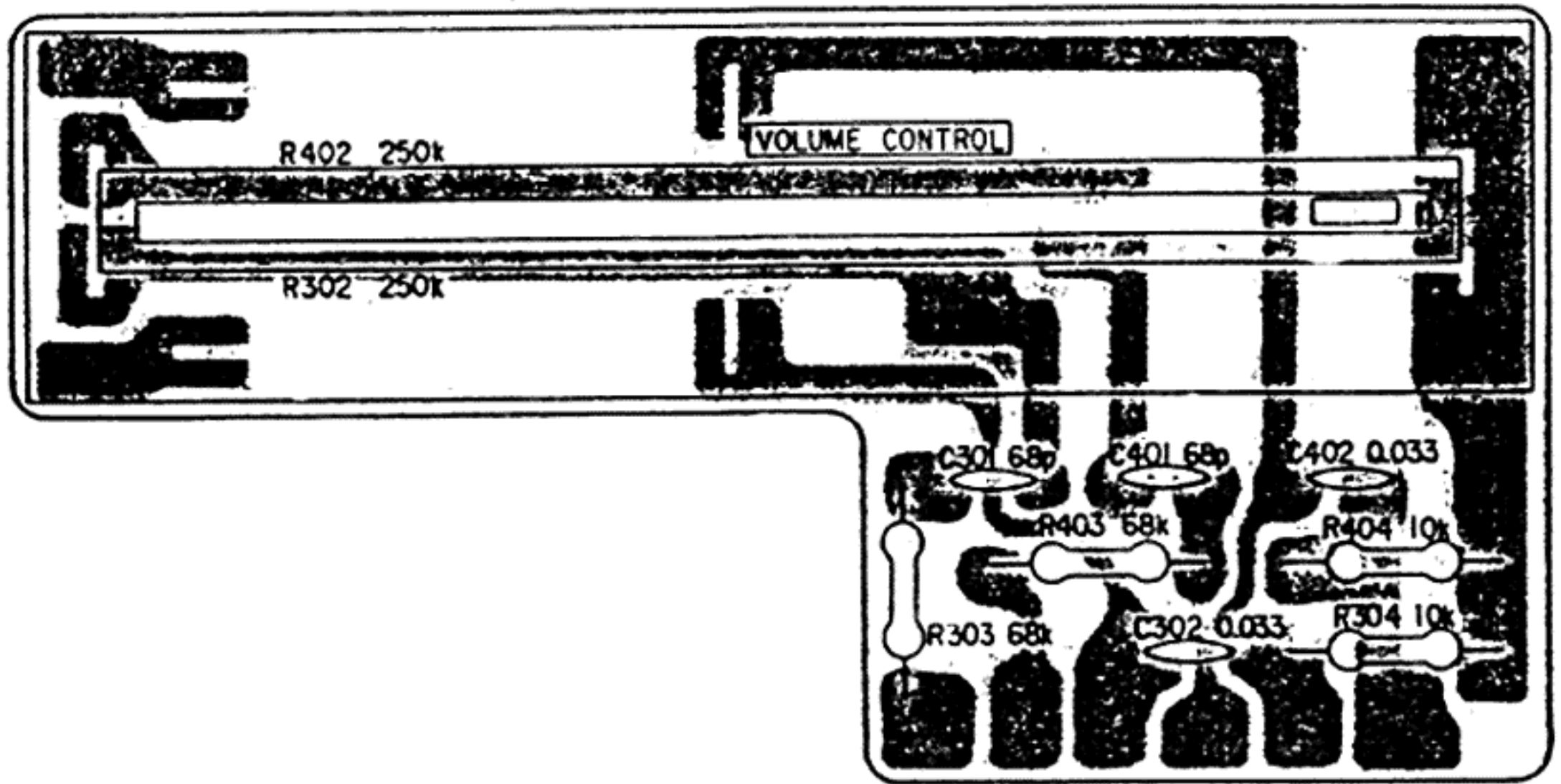

4-4 MOUNTING DIAGRAM — Preamplifier/Power Supply Board —
Conductor Side

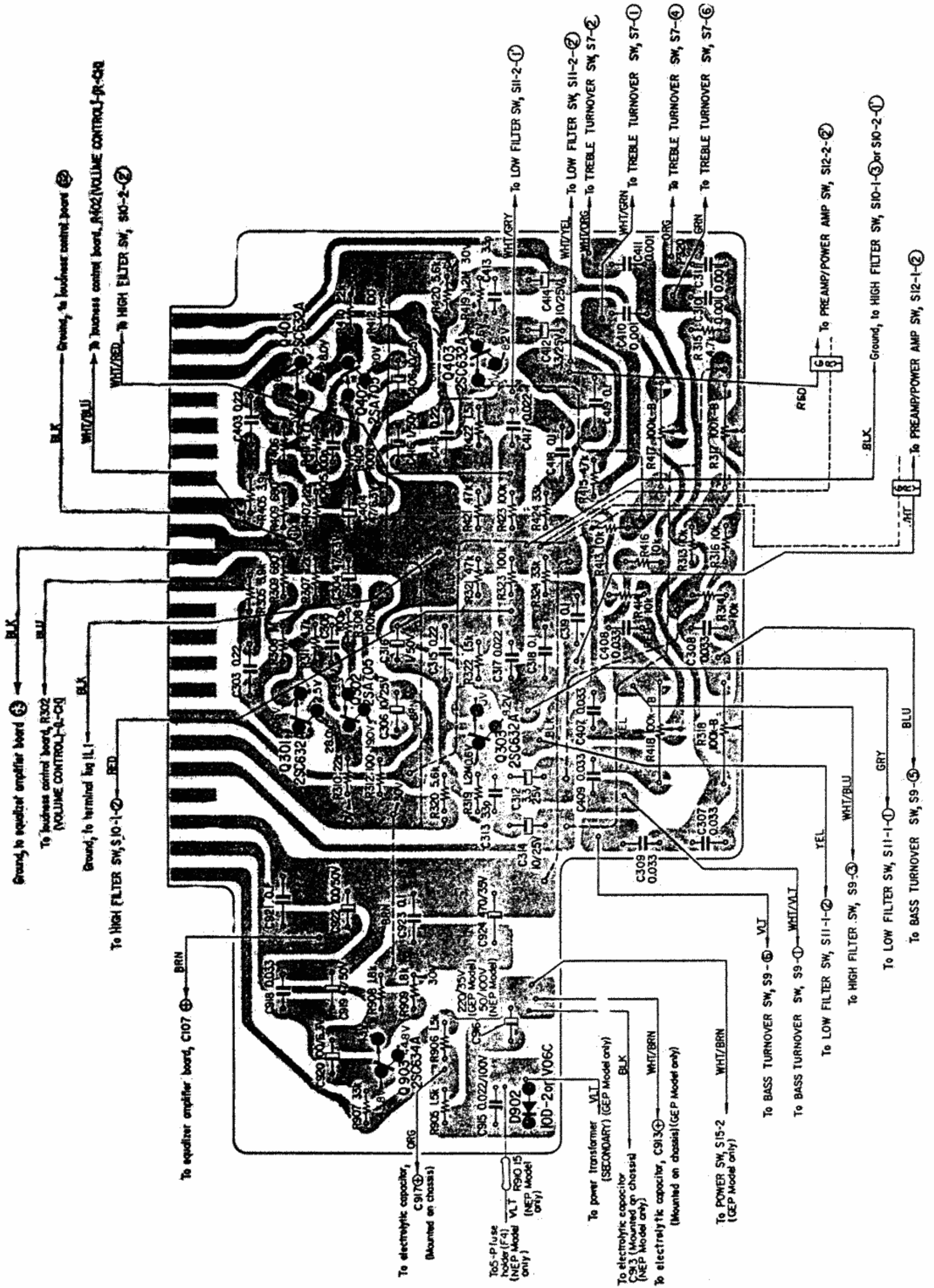

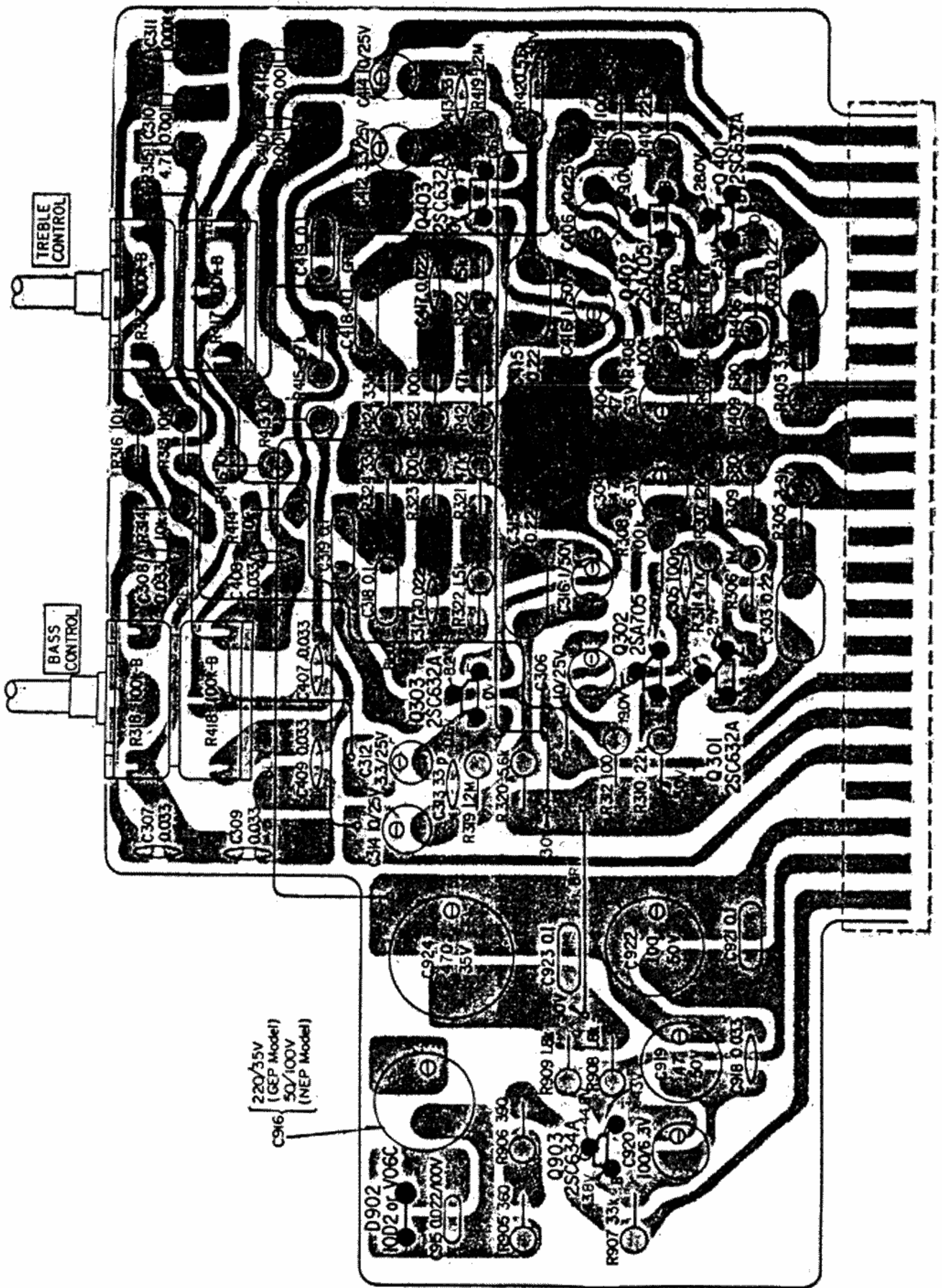

4-5. MOUNTING DIAGRAM — Equalizer Amplifier Board —
 Conductor Side —

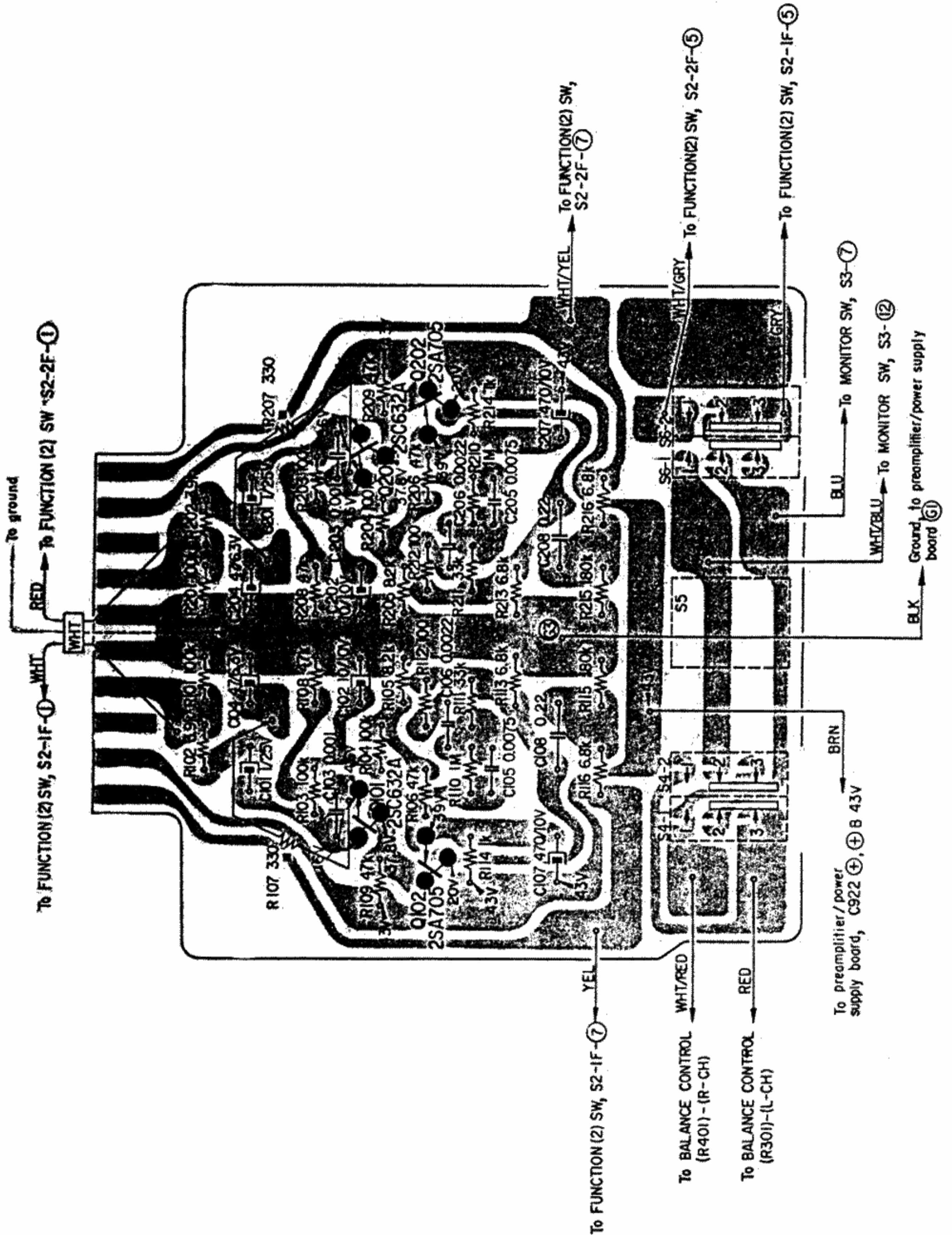

— Component Side —

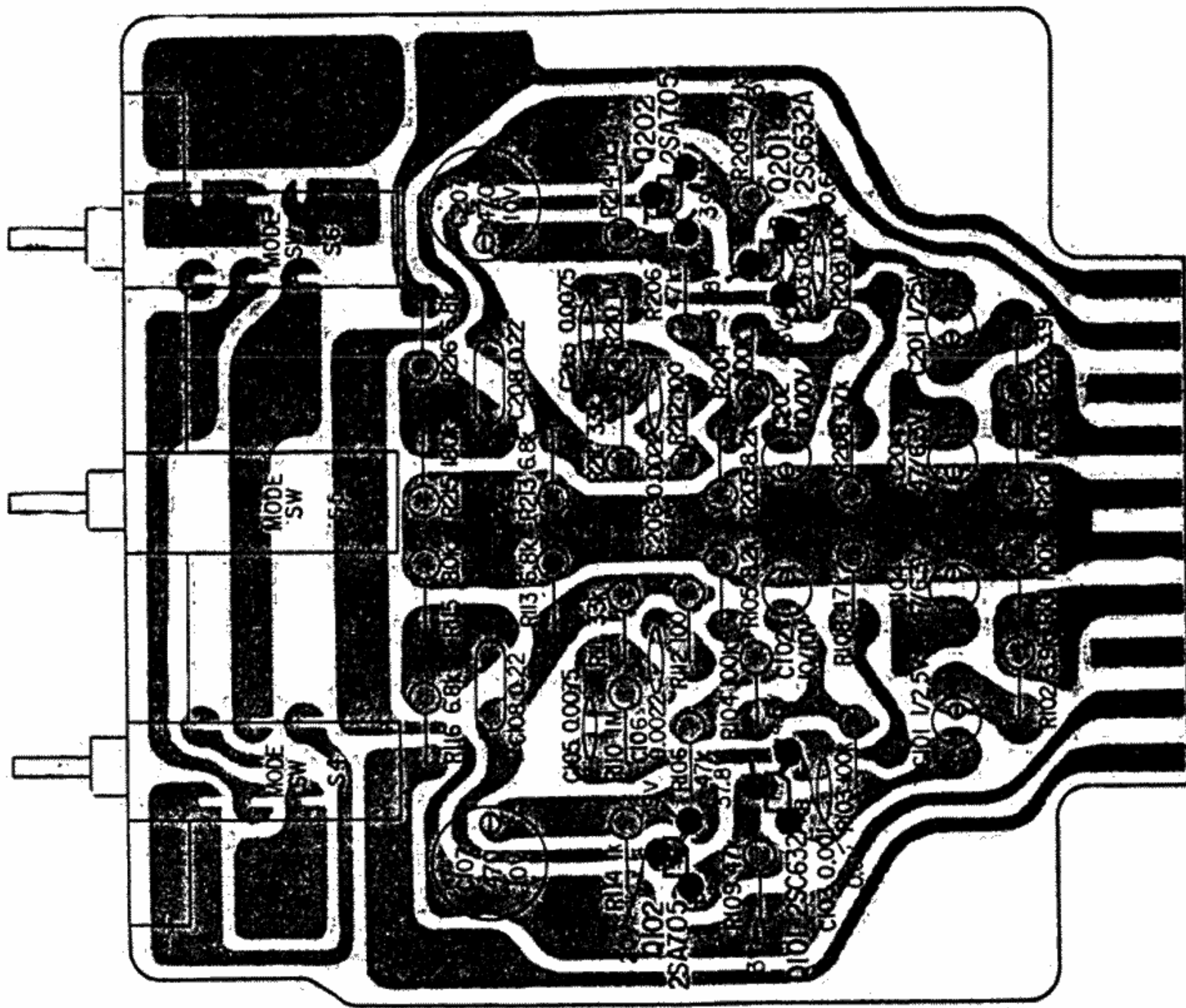

4-6 MOUNTING DIAGRAM — Power Amplifier/Power Supply Board —

— Conductor Side —

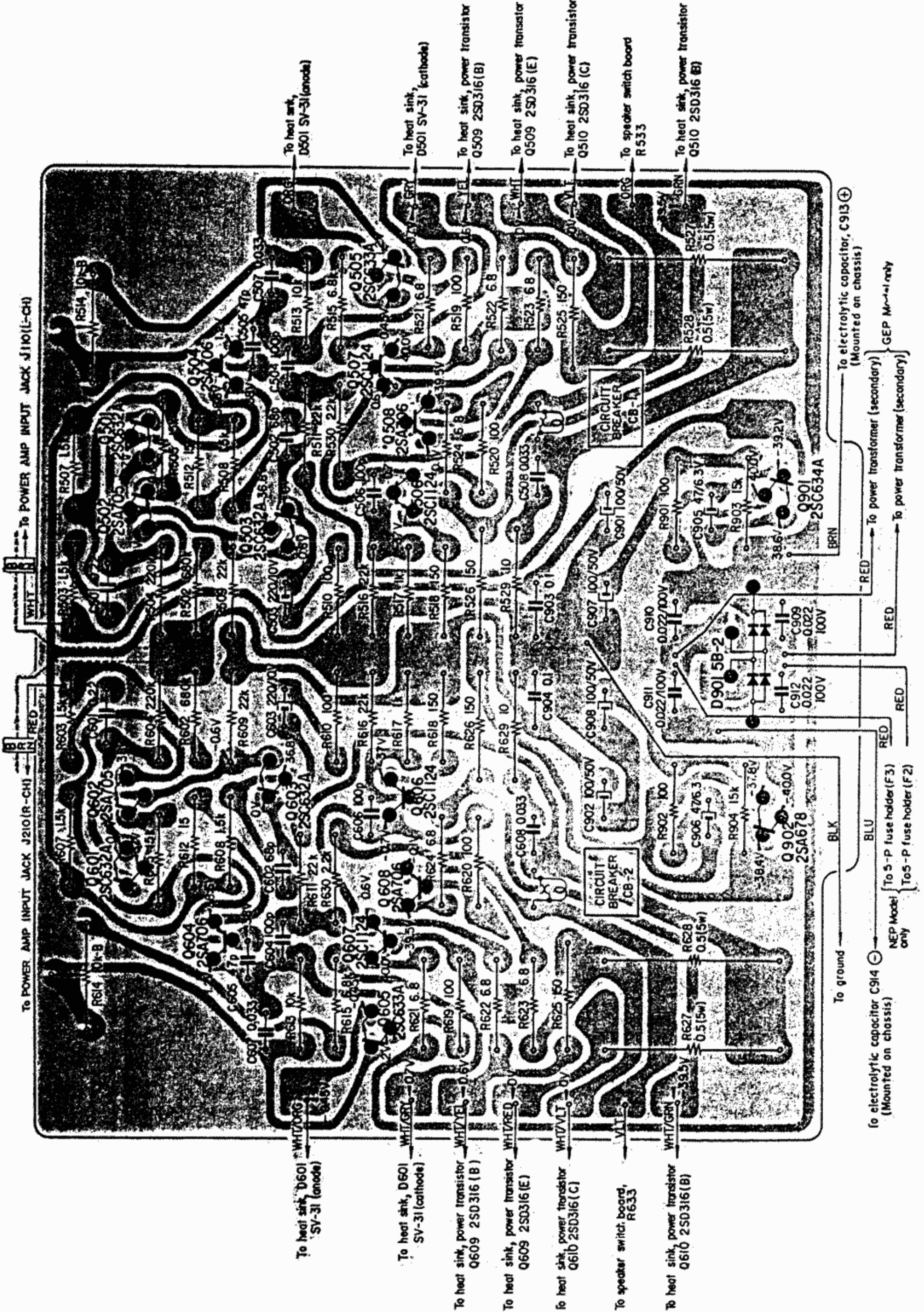

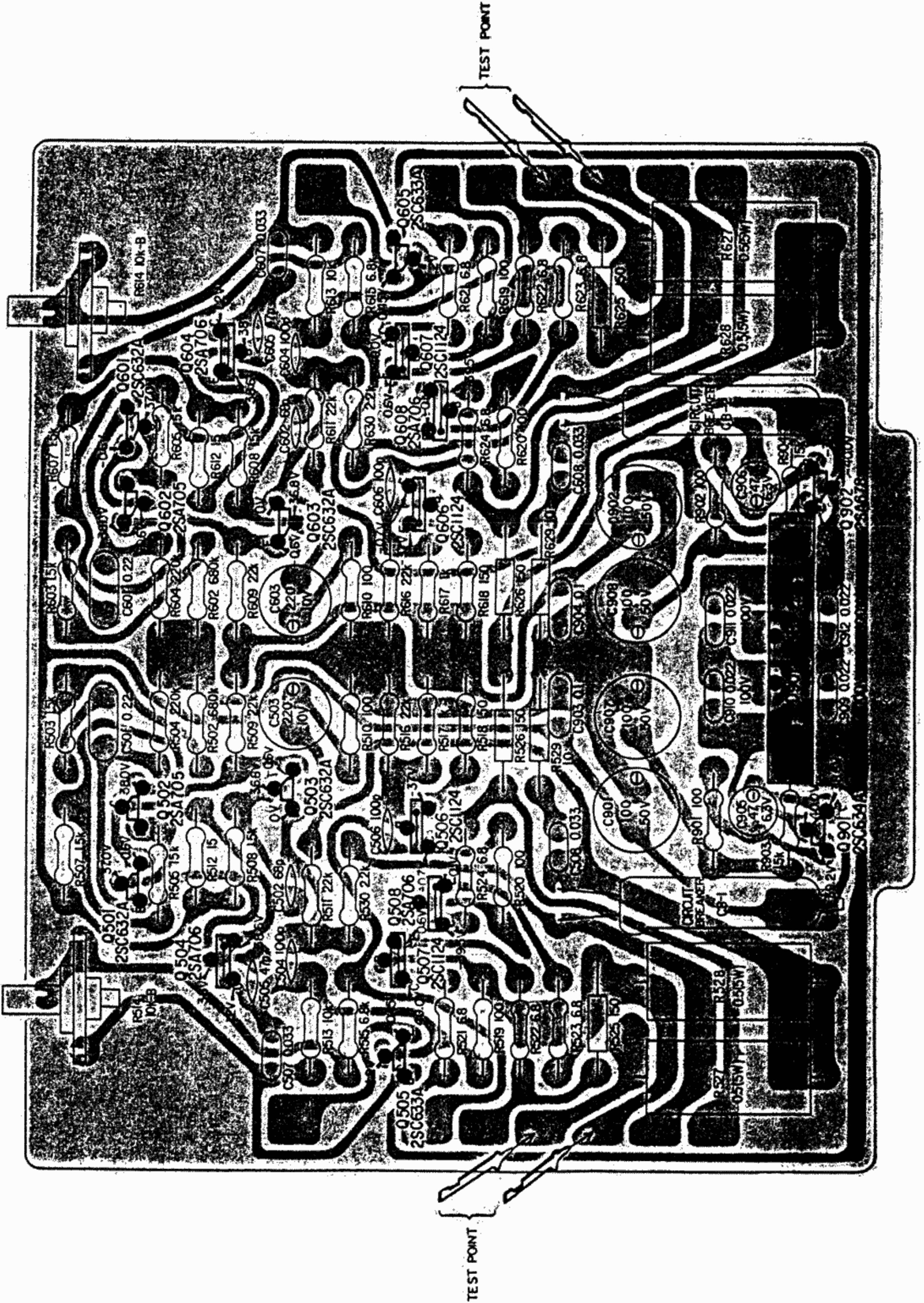

4-7 MOUNTING DIAGRAM — Speaker Switch Board —
 Conductor Side —

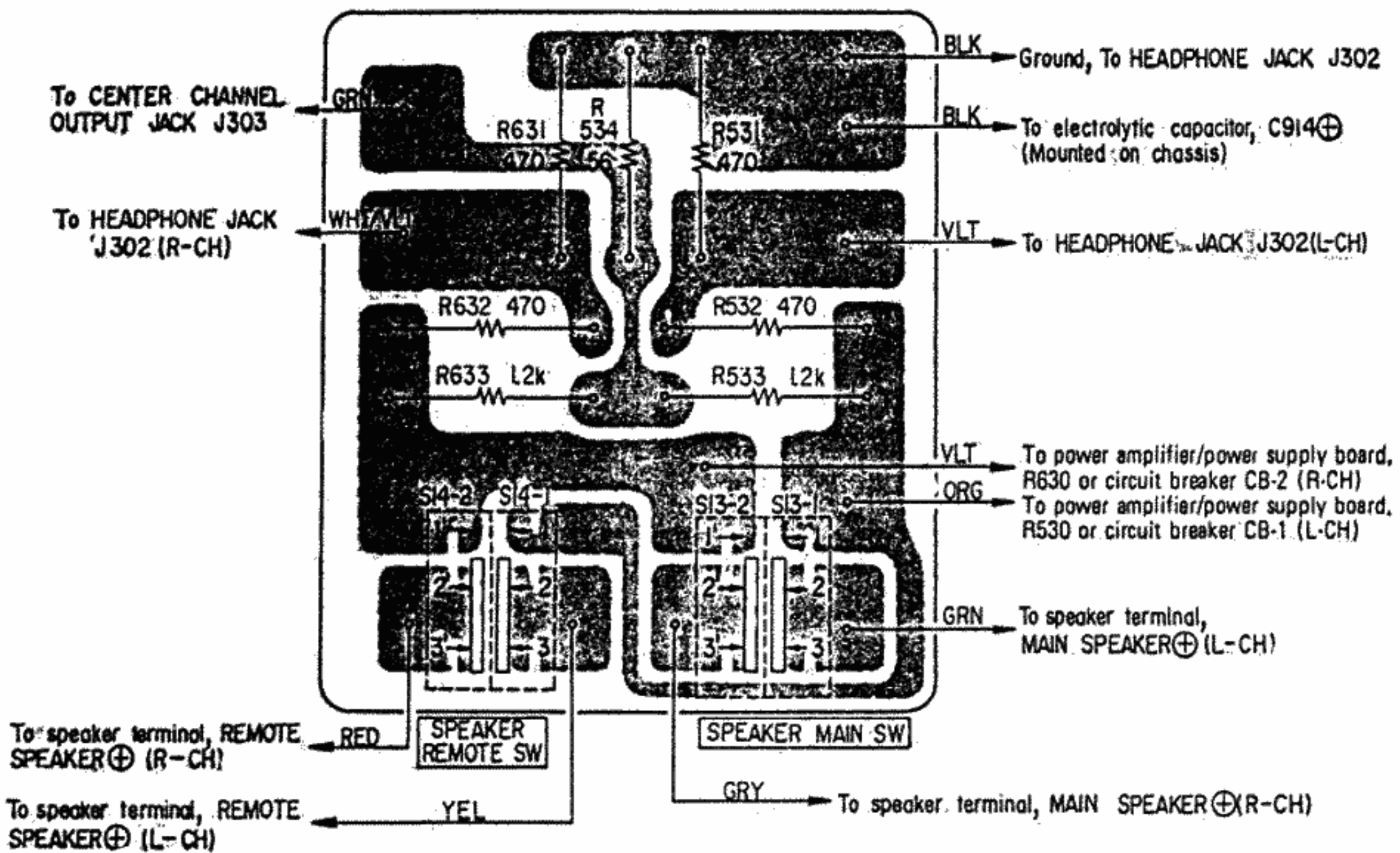

Component Side

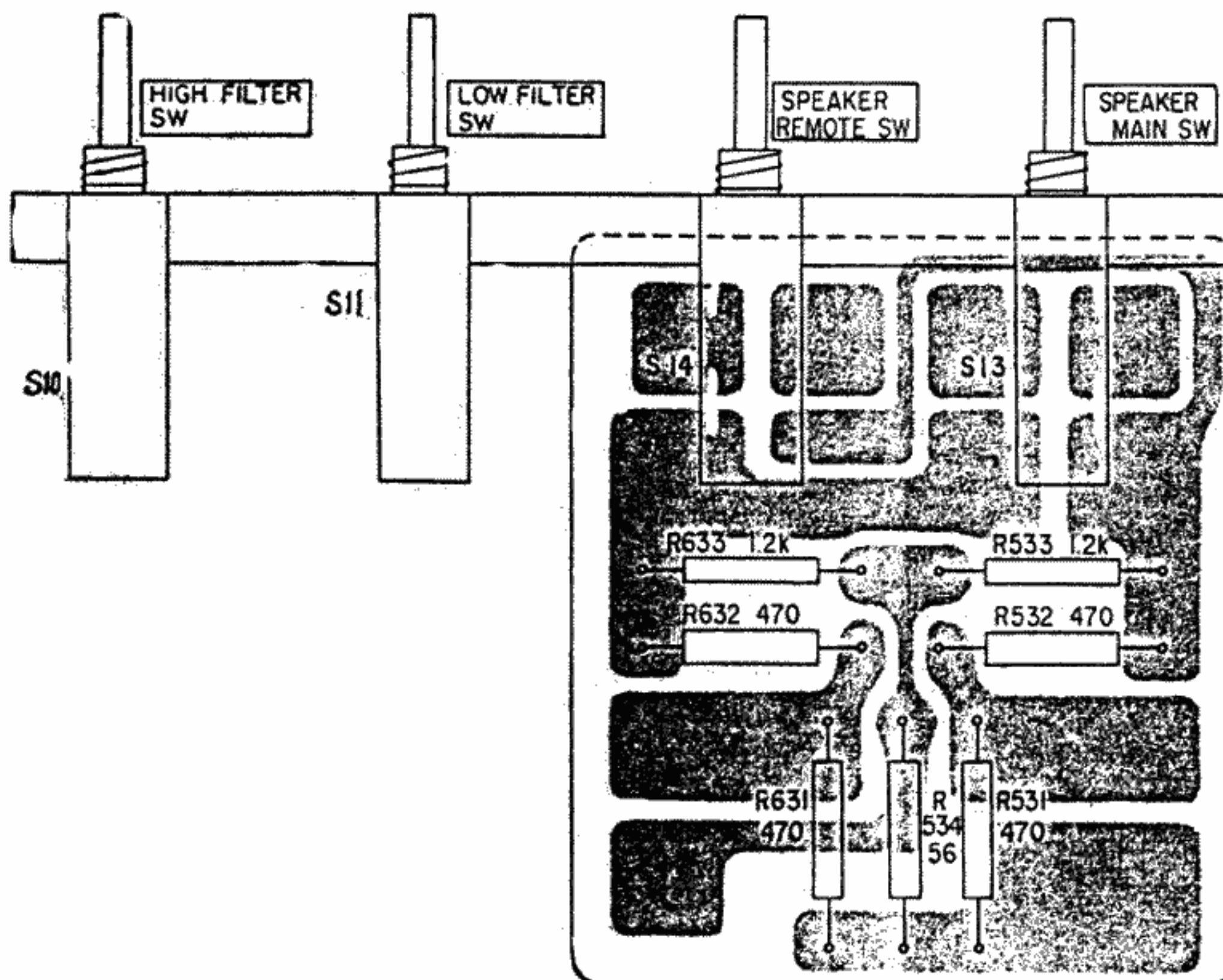

SECTION 5 REPACKING

The TA-1140's original shipping carton and packing materials are the ideal containers for shipping the unit. However to secure the maximum

protection, the TA-1140 must be repacked in these materials precisely as before. The proper repacking procedures are shown in Fig. 5-1

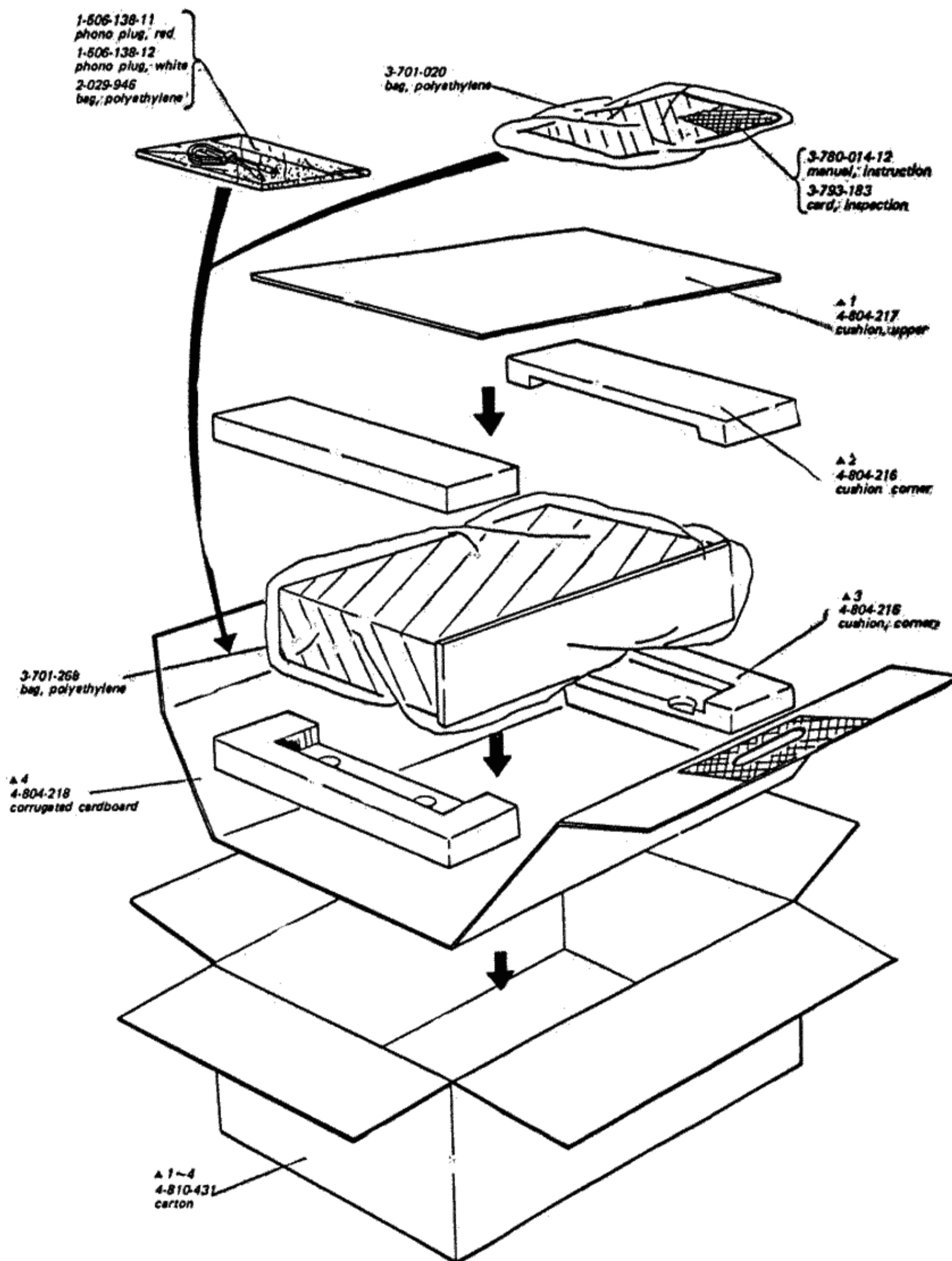

Note: ▲ 1~4 carton ass'y (X-48104-11) includes all the parts marked ▲.

Fig. 5-1. Repacking

SECTION 6 EXPLODED VIEWS

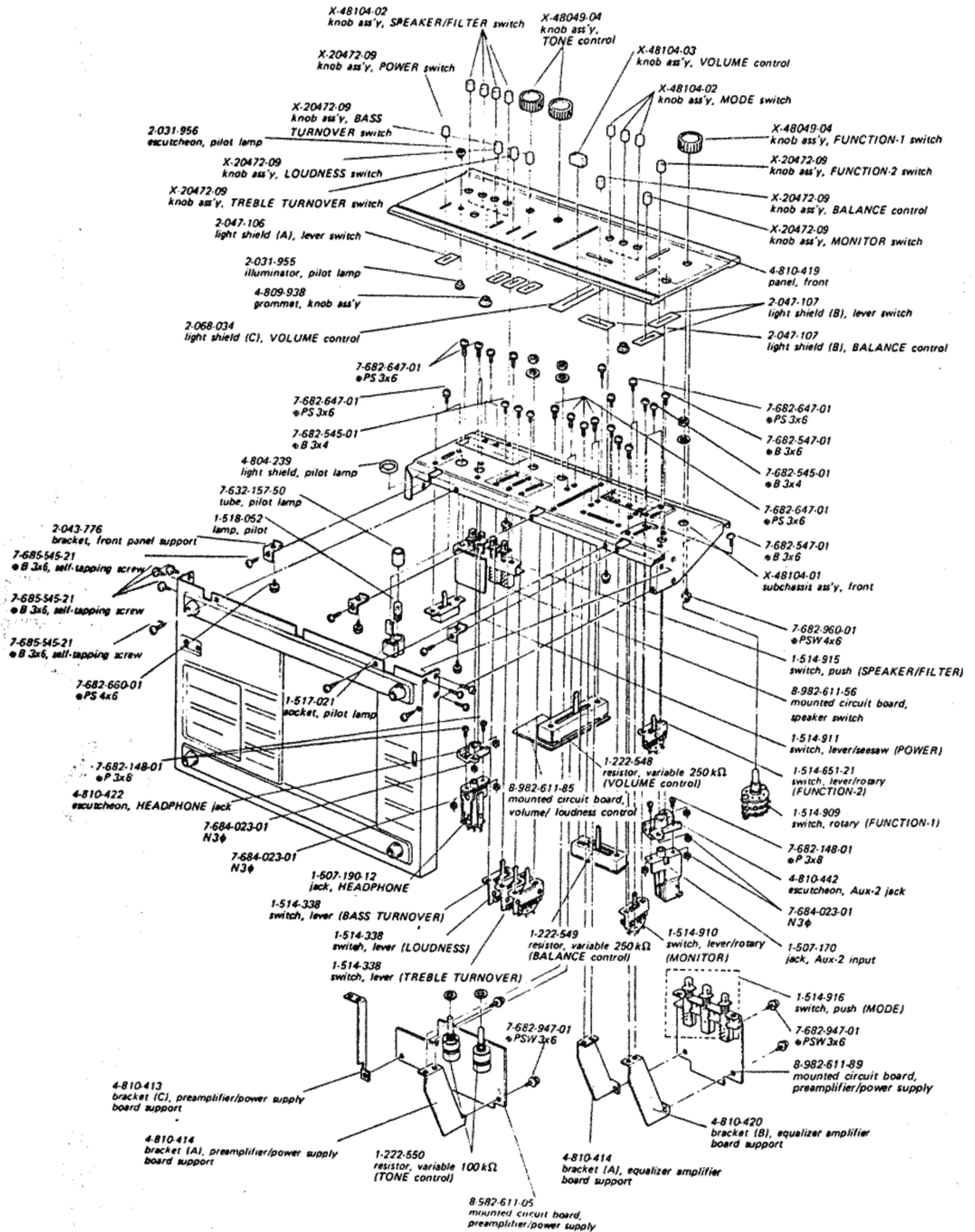

GEP, NEP Model only

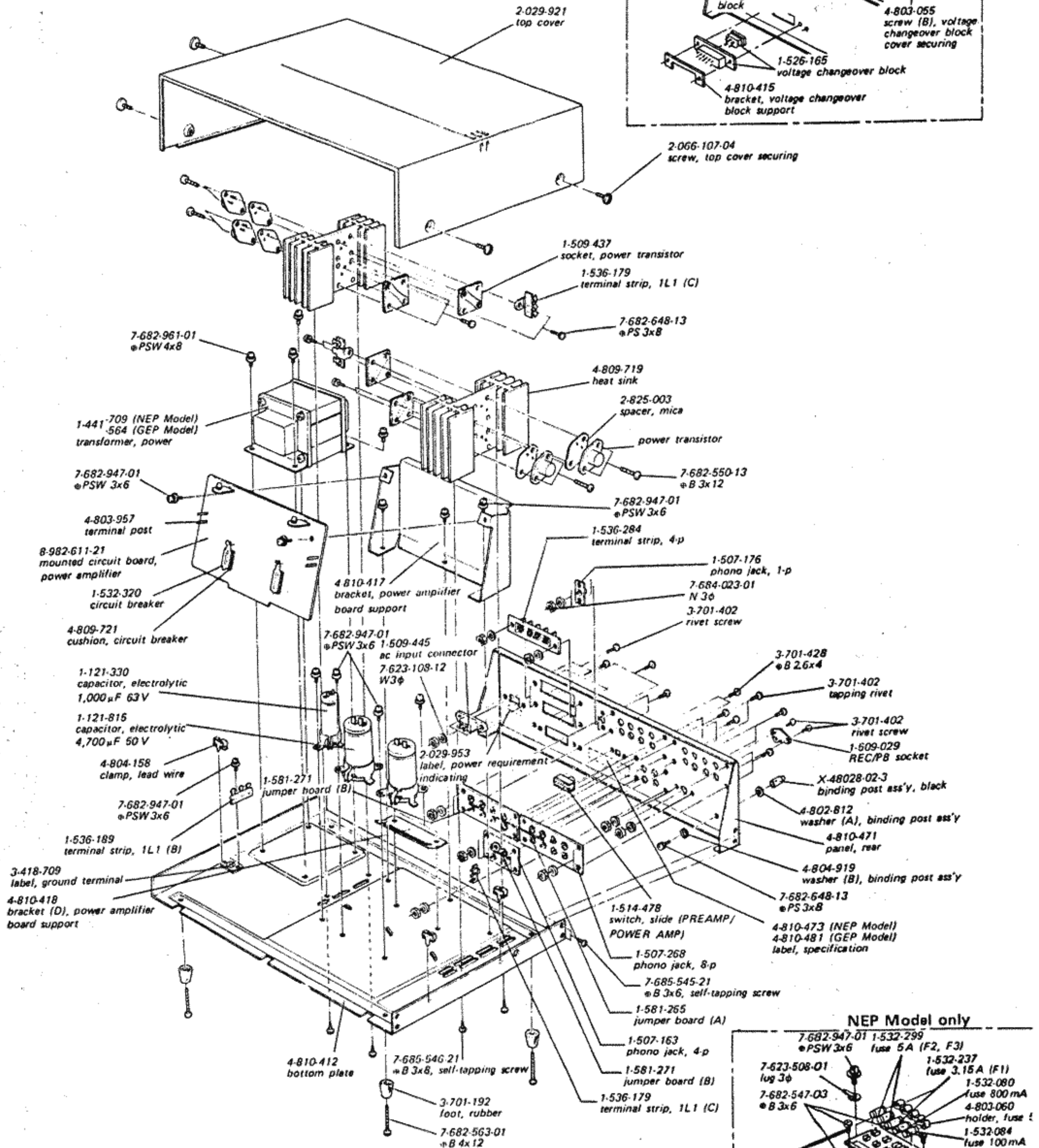
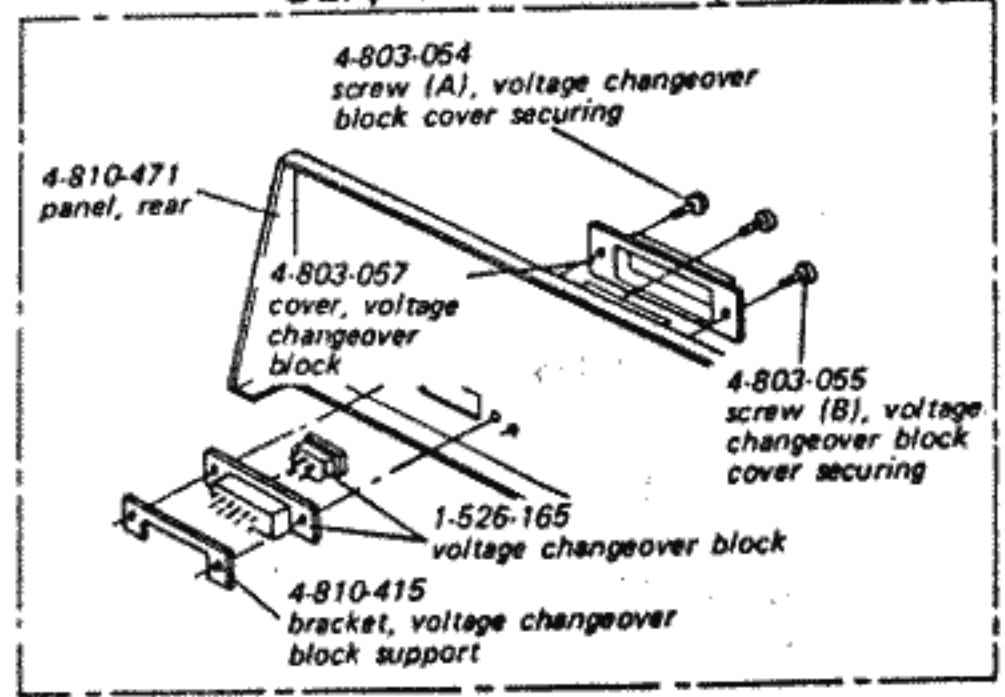

NEP Model only

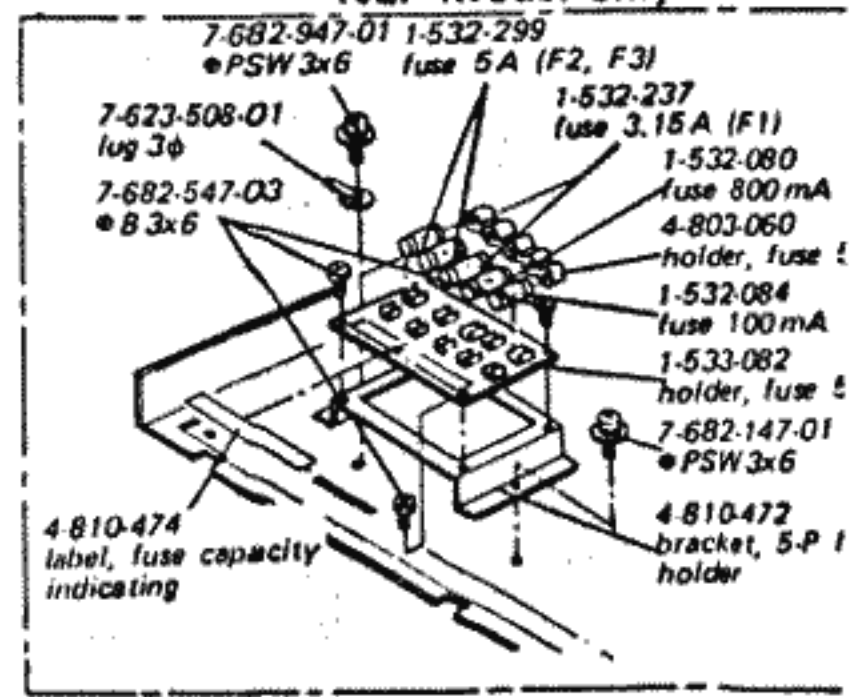

SECTION 7 ELECTRICAL PARTS LIST

<u>Ref. No.</u>	<u>Part No.</u>	<u>Description</u>	<u>Ref. No.</u>	<u>Part No.</u>	<u>Description</u>
MOUNTED CIRCUIT BOARDS			C107 (C207)	1-121-425	470 ±100% 10V electrolytic
8-982-611-05		preamplifier/power supply circuit board	C108 (C208)	1-105-689-12	0.22 ±10% 50V mylar
8-982-611-21		power amplifier/power supply circuit board	C301 (C401)	1-101-888	68p ±5% 50V ceramic
8-982-611-56		speaker switch circuit board	C302 (C402)	1-105-679-12	0.033 ±10% 50V mylar
8-982-611-85		volume/loudness control circuit board	C303 (C403)	1-105-689-12	0.22 ±10% 50V mylar
8-982-611-89		equalizer amplifier circuit board	C304 (C404)	1-121-927	47 ±100% 6.3V electrolytic
SEMICONDUCTORS			C305 (C405)	1-102-973	100p ±5% 50V ceramic
D501 (D601)		varistor SV-31	C306 (C406)	1-121-748	10 ±100% 25V electrolytic
D901		diode 5B-2	C307 (C407)	1-105-679-12	0.033 ±10% 50V mylar
D902		diode 10D-2	C308 (C408)	1-105-679-12	0.033 ±10% 50V mylar
Q101 (Q201)		transistor 2SC632A	C309 (C409)	1-105-679-12	0.033 ±10% 50V mylar
Q102 (Q202)		transistor 2SA705	C310 (C410)	1-105-661-12	0.001 ±10% 50V mylar
Q301 (Q401)		transistor 2SC632A	C311 (C411)	1-105-661-12	0.001 ±10% 50V mylar
Q302 (Q402)		transistor 2SA705	C312 (C412)	1-121-913	3.3 ±150% 25V electrolytic
Q303 (Q403)		transistor 2SC632A	C313 (C413)	1-102-963	33p ±5% 50V ceramic
Q501 (Q601)		transistor 2SC632A	C314 (C414)	1-121-748	10 ±100% 25V electrolytic
Q502 (Q602)		transistor 2SA705	C315 (C415)	1-105-689-12	0.22 ±10% 50V mylar
Q503 (Q603)		transistor 2SC632A	C316 (C416)	1-121-391	1 ±150% 50V electrolytic
Q504 (Q604)		transistor 2SA706	C317 (C417)	1-105-677-12	0.022 ±10% 50V mylar
Q505 (Q605)		transistor 2SC633A	C318 (C418)	1-105-685-12	0.1 ±10% 50V mylar
Q506 (Q606)		transistor 2SC1124	C319 (C419)	1-105-685-12	0.1 ±10% 50V mylar
Q507 (Q607)		transistor 2SC1124	C501 (C601)	1-105-689-12	0.22 ±10% 50V mylar
Q508 (Q608)		transistor 2SA706	C502 (C602)	1-101-888	68p ±5% 50V ceramic
Q509 (Q609)		transistor 2SD316	C503 (C603)	1-121-420	220 ±100% 10V electrolytic
Q510 (Q610)		transistor 2SD316	C504 (C604)	1-102-973	100p ±5% 50V ceramic
Q901		transistor 2SC634A	C505 (C605)	1-101-880	47p ±5% 50V ceramic
Q902		transistor 2SA678	C506 (C606)	1-102-973	100p ±5% 50V ceramic
Q903		transistor 2SC634A	C507 (C607)	1-105-679-12	0.033 ±10% 50V mylar
TRANSFORMER			C508 (C608)	1-105-679-12	0.033 ±10% 50V mylar
T	1-441-564	transformer, power (GEP Model)	C901 (C902)	1-121-417	100 ±100% 50V electrolytic
	1-441-709	transformer, power (NEP Model)	C903 (C904)	1-105-685-12	0.1 ±10% 50V mylar
CAPACITORS			C905 (C906)	1-121-407	47 ±100% 6.3V electrolytic
All capacitance values are in μF except as indicated with p, which means μμF.			C907 (C908)	1-121-417	100 ±100% 50V electrolytic
C101 (C201)	1-131-134	1 ±40% 25V tantalum	C909 (C910)	1-105-717-12	0.022 ±10% 100V mylar
C102 (C202)	1-121-469	10 ±100% 10V electrolytic	C911 (C912)	1-105-717-12	0.022 ±10% 100V mylar
C103 (C203)	1-105-661-12	0.001 ±10% 50V mylar	C913	1-121-815	4,700 ±100% 50V electrolytic
C104 (C204)	1-121-927	47 ±100% 6.3V electrolytic	C914	1-121-815	4,700 ±100% 50V electrolytic
C105 (C205)	1-106-022-12	0.0075 ±5% 50V mylar	C915	1-105-717-12	0.022 ±10% 100V mylar
C106 (C206)	1-106-009-12	0.0022 ±5% 50V mylar	C916	1-121-261	220 ±100% 35V electrolytic
				(GEP Model)	
				1-121-559	50 ±100% 100V electrolytic
				(NEP Model)	
			C917	1-121-330	1,000 ±100% 63V electrolytic
			C918	1-105-679-12	0.033 ±10% 50V mylar
			C919	1-121-411	47 ±100% 50V electrolytic
			C920	1-121-413	100 ±100% 6.3V electrolytic

<u>Ref. No.</u>	<u>Part No.</u>	<u>Description</u>				<u>Ref. No.</u>	<u>Part No.</u>	<u>Description</u>				
C921	1-105-685-12	0.1	±10%	50V	mylar	R323 (R423)	1-242-721	100 k				
C922	1-121-417	100	±100%	50V	electrolytic	R324 (R424)	1-242-701	15 k				
C923	1-105-685-12	0.1	±10%	50V	mylar	R502 (R602)	1-244-741	680 k				
C924	1-121-361	470	±100%	35 V	electrolytic	R503 (R603)	1-244-677	1.5 k				
						R504 (R604)	1-244-729	220 k				
						R505 (R605)	1-244-701	15 k				
						R506 (R606)		— discarded —				
						R507 (R607)	1-244-677	1.5 k				
						R508 (R608)	1-244-677	1.5 k				
						R509 (R609)	1-244-705	22 k				
						R510 (R610)	1-244-649	100				
						R511 (R611)	1-244-705	22 k				
						R512 (R612)	1-244-629	15				
						R513 (R613)	1-244-697	10 k				
						R514 (R614)	1-221-967	10 k (B), semi-fixed				
						R515 (R615)	1-244-693	6.8 k				
						R516 (R616)	1-244-705	22 k				
						R517 (R617)	1-244-673	1 k				
						R518 (R618)	1-244-653	150				
						R519 (R619)	1-242-649	100				
						R520 (R620)	1-244-649	100				
						R521 (R621)	1-244-621	6.8				
						R522 (R622)	1-244-621	6.8				
						R523 (R623)	1-244-621	6.8				
						R524 (R624)	1-244-621	6.8				
						R525 (R625)	1-202-553	150	±10%	½W	compos	
						R526 (R626)	1-202-553	150	±10%	½W	compos	
						R527 (R627)	1-205-803	0.5	±10%	5W	wire-wc	
						R528 (R628)	1-205-803	0.5	±10%	5W	wire-wc	
						R529 (R629)	1-202-525	10	±10%	½W	compos	
						R530 (R630)	1-244-681	2.2 k				
						R531 (R631)	1-202-565	470	±10%	½W	compos	
						R532 (R632)	1-202-565	470	±10%	½W	compos	
						R533 (R633)	1-202-575	1.2 k	±10%	½W	compos	
						R534	1-202-543	56	±10%	½W	compos	
						R801	1-244-735	390 k				
						R802	1-244-735	390 k				
						R803	1-244-719	82 k				
						R804	1-244-719	82 k				
						R805	1-244-697	10 k				
						R806	1-244-697	10 k				
						R807	1-244-697	10 k				
						R808	1-244-697	10 k				
						R901 (R902)	1-244-649	100				
						R903 (R904)	1-244-701	15 k				
						R905	1-202-562	360	±10%	½W	compo	
						R906	1-202-563	390	±10%	½W	compo	

RESISTORS

All resistors are in ohms, ±5%, ¼W and carbon type unless otherwise indicated.

<u>Ref. No.</u>	<u>Part No.</u>	<u>Description</u>	<u>Ref. No.</u>	<u>Part No.</u>	<u>Description</u>
R907	1-242-709	33 k			
R908	1-202-579	1.8 k ±10% ½W composition			
R909	1-202-579	1.8 k ±10% ½W composition			
R910	1-206-059	220 ±10% 2W metal oxide (GEP Model)			
	1-244-629	15 (NEP Model)			
SWITCHES					
S1	1-514-90	switch, rotary (FUNCTION-1)			
S2	1-514-651-21	switch, lever/rotary (FUNCTION-2)			
S3	1-514-910	switch, lever/rotary (MONITOR)			
S4					
S5	1-514-916-11	combination switch, push (MODE)			
S6					
S7	1-513-338	switch, lever (TREBLE TURNOVER)			
S8	1-513-338	switch, lever (LOUDNESS)			
S9	1-513-338	switch, lever (BASS TURNOVER)			
S10	1-514-915	(HIGH FILTER)			
S11		combination (LOW FILTER)			
S13		switch, push (MAIN SPEAKER)			
S14		(REMOTE SPEAKER)			
S12	1-514-478	switch, slide (PREAMP/POWER AMP)			
S15	1-514-911	switch, lever/seesaw (POWER)			
MISCELLANEOUS					
CP	1-231-057	encapsulated component, 120 Ω + 0.33 μF (GEP Model only)			
	1-507-163	phono jack, 4-P			
J301	1-507-170	jack, AUX-2			
	1-507-176	phono jack, 1-P			
J302	1-507-190-12	jack, HEADPHONE			
	1-507-268	phono jack, 8-P			
CNJ2, 3, 4	1-509-341	ac outlet			
	1-509-029	rec/pb connector			
	1-509-437	socket, power transistor			
	1-517-021	socket, pilot lamp			
	1-518-052	lamp, pilot			
	1-526-165	voltage changeover block			
	1-532-320	circuit breaker (CB-1, CB-2)			
	1-534-487	cord, power			
	1-536-179	terminal strip, 1L1 (C)			
	1-536-189	terminal strip, 1L1 (B) (GEP Model only)			
	1-536-284	terminal strip, 4-P			
	1-581-265	jumper board (A)			
	1-581-271	jumper board (B)			
F1, 2	1-532-252	fuse 2.5A (GEP Model only)			
F1	1-532-237	fuse 3.15A			(NEP Model only)
F2, 3	1-532-299	fuse 5A			
F4	1-532-084	fuse 100 mA			
F5	1-532-080	fuse 800 mA			
	1-509-445	ac input connector			
	1-533-082	fuse holder, 5-P			

SONY CORPORATION

© 1971