



# TCA5550

## STEREO SOUND CONTROL SYSTEM

The TCA5550 is a single chip stereo balance, volume, bass and treble control circuit designed for use in car radios, TV, and audio systems. Simple dc inputs allow the control to be effected by four inexpensive potentiometers or a remote control system. The bass and treble responses are defined by a single capacitor per channel.

- Four High Impedance dc Controls — Vol, Bass, Treble, Balance
- A Single External Capacitor Defines Each Tone Control Characteristic
- Low Distortion, 0.1% at Nominal Input Level, Unity Gain with the Tone Controls Flat
- Channel Separation Better Than 45 dB
- Wide Power Supply Tolerance, 10 to 16 Vdc
- $\pm 14$  dB of Tone Control
- More Than 75 dB of Volume Control
- Wide Dynamic Range: 100 mV to 500 mV<sub>rms</sub> Input Signal
- Low Output Impedance

## STEREO SOUND CONTROL SYSTEM

SILICON MONOLITHIC INTEGRATED CIRCUIT



P SUFFIX  
PLASTIC PACKAGE  
CASE 707-02

FIGURE 1 — BLOCK DIAGRAM

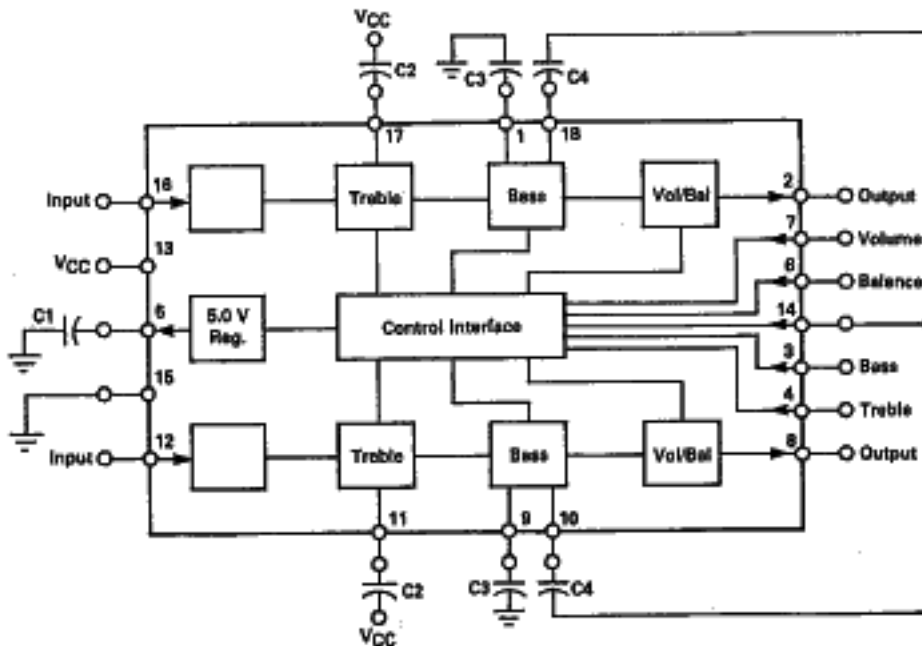

MOTOROLA LINEAR/INTERFACE DEVICES

MAXIMUM RATINGS (T<sub>A</sub> = +25°C)

Rating	Value	Unit
Power Supply Voltage	18	Volts
Power Dissipation (Package Limitation)	1250	mW
Derate above T <sub>A</sub> = +25°C	10	mW/°C
Operating Temperature Range (Ambient)	-40 to +85	°C
Storage Temperature Range	-65 to +150	°C

ELECTRICAL CHARACTERISTICS (T<sub>A</sub> = 25°C, V<sub>CC</sub> = 12 Vdc)

Characteristic	Pin	Min	Typ	Max	Unit
Supply Voltage	13	10	—	18	Vdc
Supply Current I <sub>s</sub>		Min Gain	—	30	mA
		Max Gain	—	15	
Regulated Output Voltage <sup>1</sup>	5	—	5.0	—	V
		Current	—	—	
Input Levels	12, 16	Max Gain	—	100	mV <sub>rms</sub>
		With Reduced Gain <sup>3</sup>	—	—	
Input Impedance	12, 16	—	100	—	kΩ
Output Impedance	2, 8	—	300	—	Ω
Tone Control Range (at 70 Hz & 10 kHz) <sup>2</sup>	3, 4	With Pins 3 & 4 @ 0.5 V	—	-14	dB
		With Pins 3 & 4 @ 2.3 V	—	0	
		With Pins 3 & 4 @ 4.1 V	—	+14	
		—	—	—	
Balance Control Range (Constant Power Link)	6	Min Gain	—	-35	dB
		Max Gain	—	+3.0	
Volume Control Range	7	With Pin 7 @ 0 V	—	80	dB
		With Pin 7 @ 3.1 V	—	+10	
		With Pin 7 @ 4.1 V	—	-20	
		With Pin 7 @ V <sub>PN 5</sub>	—	-70	
Control Input Currents	3, 4, 6, 7	—	—	±1.0	μA
Channel Separation		45	—	—	dB
Distortion (at 1.0 kHz) at 300 mV <sub>rms</sub> Output <sup>3</sup>		—	0.1	—	%
Signal : Noise Ratio		—	70	—	dB
Noise Level		—	90	—	μV <sub>rms</sub>
50 Hz to 15 kHz, Min Gain					

## NOTES:

- The control potentiometers to this point, see Figure 7.
- These figures are functions of the capacitors on Pins 1, 5, 10, 11, 17 & 18. See the application diagram, Figure 7.
- The input level may be increased to 500 mV<sub>rms</sub> but the user controls must be adjusted to ensure that the output level does not exceed 300 mV<sub>rms</sub>.

T-77-05-09

PERFORMANCE CHARACTERISTICS, FIGURES 2-7, TAKEN IN CIRCUIT OF FIGURE 8,  $V_{CC} = 12\text{ V}$

FIGURE 2 — MIDBAND DISTORTION

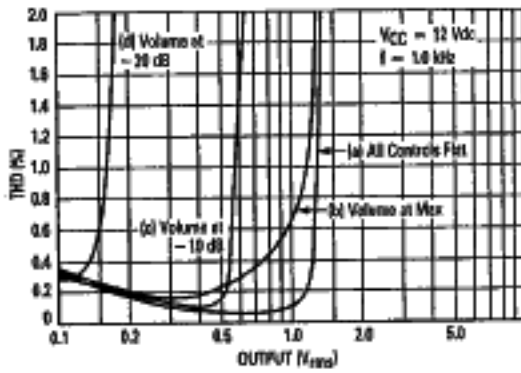

FIGURE 3 — VOLUME CONTROL CHARACTERISTICS

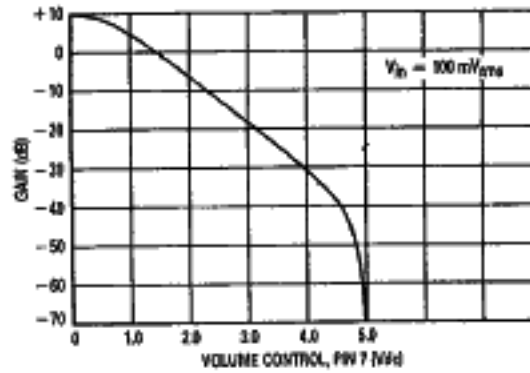

FIGURE 4 — TONE CONTROL CHARACTERISTICS

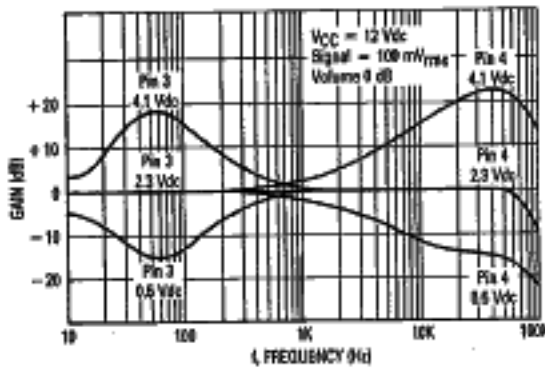

FIGURE 5 — HIGH FREQUENCY DISTORTION

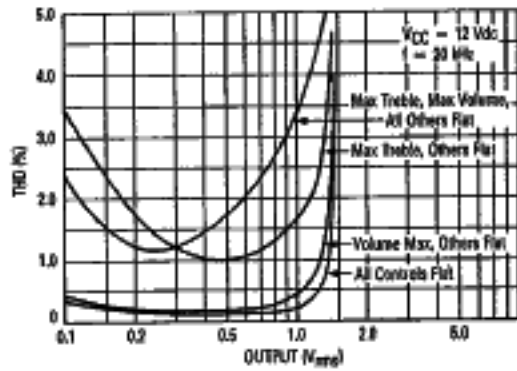

FIGURE 6 — LOW FREQUENCY DISTORTION

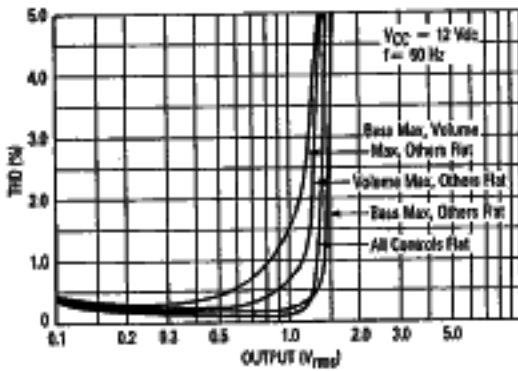
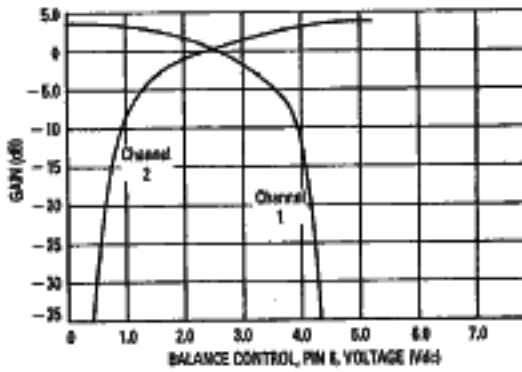
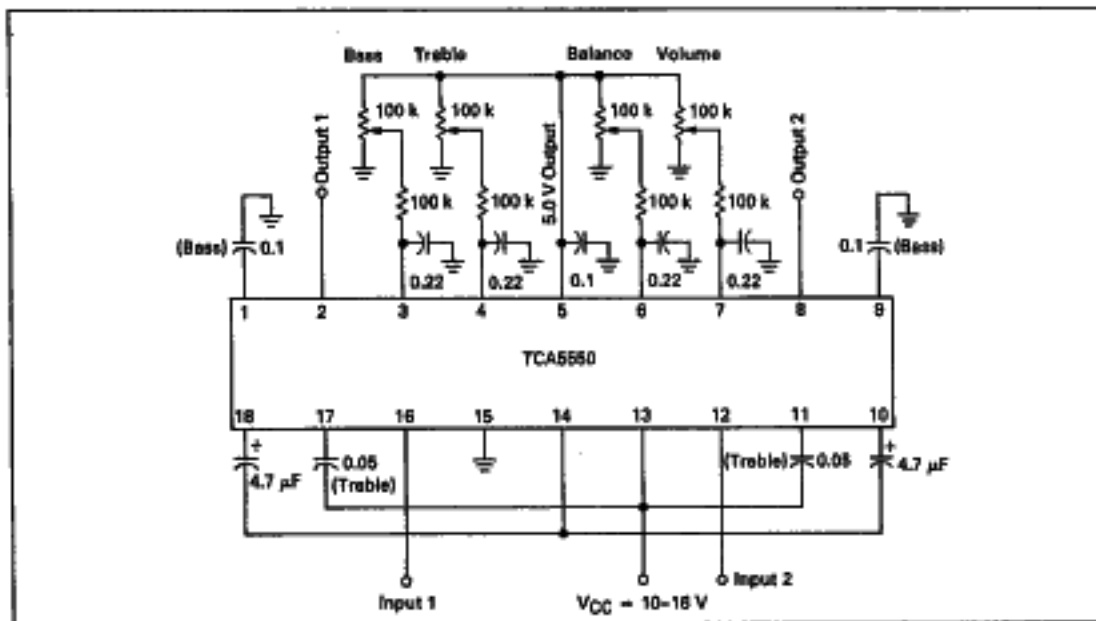

FIGURE 7 — BALANCE CONTROL CHARACTERISTIC



T-77-05-09

FIGURE 8 — APPLICATION CIRCUIT



9