

IR2112(-1-2)(S)PbF

HIGH AND LOW SIDE DRIVER

Features

- Floating channel designed for bootstrap operation
- Fully operational to +600V
- Tolerant to negative transient voltage
dV/dt immune
- Gate drive supply range from 10 to 20V
- Undervoltage lockout for both channels
- 3.3V logic compatible
Separate logic supply range from 3.3V to 20V
Logic and power ground $\pm 5V$ offset
- CMOS Schmitt-triggered inputs with pull-down
- Cycle by cycle edge-triggered shutdown logic
- Matched propagation delay for both channels
- Outputs in phase with inputs

Description

The IR2112(S) is a high voltage, high speed power MOSFET and IGBT driver with independent high and low side referenced output channels. Proprietary HVIC and latch immune CMOS technologies enable ruggedized monolithic construction. Logic inputs are compatible with standard CMOS or LSTTL outputs, down to 3.3V logic.

The output drivers feature a high pulse current buffer stage designed for minimum driver cross-conduction. Propagation delays are matched to simplify use in high frequency applications. The floating channel can be used to drive an N-channel power MOSFET or IGBT in the high side configuration which operates up to 600 volts.

Product Summary

V_{OFFSET}	600V max.
$I_{\text{O}+/-}$	200 mA / 420 mA
V_{OUT}	10 - 20V
$t_{\text{on/off (typ.)}}$	125 & 105 ns
Delay Matching	30 ns

Packages

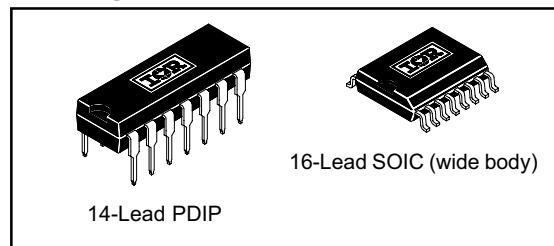

Typical Connection

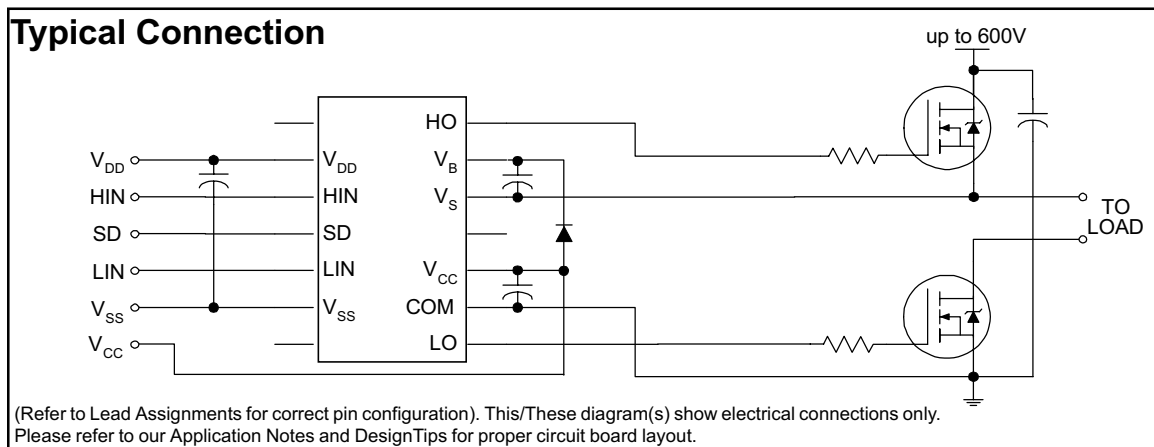

Absolute Maximum Ratings

Absolute Maximum Ratings indicate sustained limits beyond which damage to the device may occur. All voltage parameters are absolute voltages referenced to COM. The Thermal Resistance and Power Dissipation ratings are measured under board mounted and still air conditions. Additional information is shown in Figures 28 through 35.

Symbol	Definition	Min.	Max.	Units
V _B	High Side Floating Supply Voltage	-0.3	625	V
V _S	High Side Floating Supply Offset Voltage	V _B - 25	V _B + 0.3	
V _{HO}	High Side Floating Output Voltage	V _S - 0.3	V _B + 0.3	
V _{CC}	Low Side Fixed Supply Voltage	-0.3	25	
V _{LO}	Low Side Output Voltage	-0.3	V _{CC} + 0.3	
V _{DD}	Logic Supply Voltage	-0.3	V _{SS} + 25	
V _{SS}	Logic Supply Offset Voltage	V _{CC} - 25	V _{CC} + 0.3	
V _{IN}	Logic Input Voltage (HIN, LIN & SD)	V _{SS} - 0.3	V _{DD} + 0.3	
dV _S /dt	Allowable Offset Supply Voltage Transient (Figure 2)	—	50	V/ns
P _D	Package Power Dissipation @ T _A ≤ +25°C (14 Lead DIP)	—	1.6	W
		(16 Lead SOIC)	1.25	
R _{THJA}	Thermal Resistance, Junction to Ambient (14 Lead DIP)	—	75	°C/W
		(16 Lead SOIC)	100	
T _J	Junction Temperature	—	150	°C
T _S	Storage Temperature	-55	150	
T _L	Lead Temperature (Soldering, 10 seconds)	—	300	

Recommended Operating Conditions

The Input/Output logic timing diagram is shown in Figure 1. For proper operation the device should be used within the recommended conditions. The V_S and V_{SS} offset ratings are tested with all supplies biased at 15V differential. Typical ratings at other bias conditions are shown in Figures 36 and 37.

Symbol	Definition	Min.	Max.	Units
V _B	High Side Floating Supply Absolute Voltage	V _S + 10	V _S + 20	V
V _S	High Side Floating Supply Offset Voltage	Note 1	600	
V _{HO}	High Side Floating Output Voltage	V _S	V _B	
V _{CC}	Low Side Fixed Supply Voltage	10	20	
V _{LO}	Low Side Output Voltage	0	V _{CC}	
V _{DD}	Logic Supply Voltage	V _{SS} + 3	V _{SS} + 20	
V _{SS}	Logic Supply Offset Voltage	-5 (Note 2)	5	
V _{IN}	Logic Input Voltage (HIN, LIN & SD)	V _{SS}	V _{DD}	
T _A	Ambient Temperature	-40	125	°C

Note 1: Logic operational for V_S of -5V to +600V. Logic state held for V_S of -5V to -V_{BS}. (Please refer to the Design Tip DT97-3 for more details).

Note 2: When V_{DD} < 5V, the minimum V_{SS} offset is limited to -V_{DD}.

Dynamic Electrical Characteristics

V_{BIAS} (V_{CC} , V_{BS} , V_{DD}) = 15V, C_L = 1000 pF, T_A = 25°C and V_{SS} = COM unless otherwise specified. The dynamic electrical characteristics are measured using the test circuit shown in Figure 3.

Symbol	Definition	Figure	Min.	Typ.	Max.	Units	Test Conditions
t_{on}	Turn-On Propagation Delay	7	—	125	180	ns	$V_S = 0V$
t_{off}	Turn-Off Propagation Delay	8	—	105	160		$V_S = 600V$
t_{sd}	Shutdown Propagation Delay	9	—	105	160		$V_S = 600V$
t_r	Turn-On Rise Time	10	—	80	130		
t_f	Turn-Off Fall Time	11	—	40	65		
MT	Delay Matching, HS & LS Turn-On/Off	—	—	—	30		

Static Electrical Characteristics

V_{BIAS} (V_{CC} , V_{BS} , V_{DD}) = 15V, T_A = 25°C and V_{SS} = COM unless otherwise specified. The V_{IH} , V_{TH} and I_{IN} parameters are referenced to V_{SS} and are applicable to all three logic input leads: HIN, LIN and SD. The V_O and I_O parameters are referenced to COM and are applicable to the respective output leads: HO or LO.

Symbol	Definition	Figure	Min.	Typ.	Max.	Units	Test Conditions
V_{IH}	Logic "1" Input Voltage	12	9.5	—	—	V	
V_{IL}	Logic "0" Input Voltage	13	—	—	6.0		
V_{OH}	High Level Output Voltage, $V_{BIAS} - V_O$	14	—	—	100	mV	$I_O = 0A$
V_{OL}	Low Level Output Voltage, V_O	15	—	—	100		$I_O = 0A$
I_{LK}	Offset Supply Leakage Current	16	—	—	50	μA	$V_B = V_S = 600V$
I_{QBS}	Quiescent V_{BS} Supply Current	17	—	25	60		$V_{IN} = 0V$ or V_{DD}
I_{QCC}	Quiescent V_{CC} Supply Current	18	—	80	180		$V_{IN} = 0V$ or V_{DD}
I_{QDD}	Quiescent V_{DD} Supply Current	19	—	2.0	5.0		$V_{IN} = 0V$ or V_{DD}
I_{IN+}	Logic "1" Input Bias Current	20	—	20	40		$V_{IN} = V_{DD}$
I_{IN-}	Logic "0" Input Bias Current	21	—	—	1.0		$V_{IN} = 0V$
V_{BSUV+}	V_{BS} Supply Undervoltage Positive Going Threshold	22	7.4	8.5	9.6	V	
V_{BSUV-}	V_{BS} Supply Undervoltage Negative Going Threshold	23	7.0	8.1	9.2		
V_{CCUV+}	V_{CC} Supply Undervoltage Positive Going Threshold	24	7.6	8.6	9.6		
V_{CCUV-}	V_{CC} Supply Undervoltage Negative Going Threshold	25	7.2	8.2	9.2		
I_{O+}	Output High Short Circuit Pulsed Current	26	200	250	—	mA	$V_O = 0V, V_{IN} = V_{DD}$ $PW \leq 10 \mu s$
I_{O-}	Output Low Short Circuit Pulsed Current	27	420	500	—		$V_O = 15V, V_{IN} = 0V$ $PW \leq 10 \mu s$

Functional Block Diagram

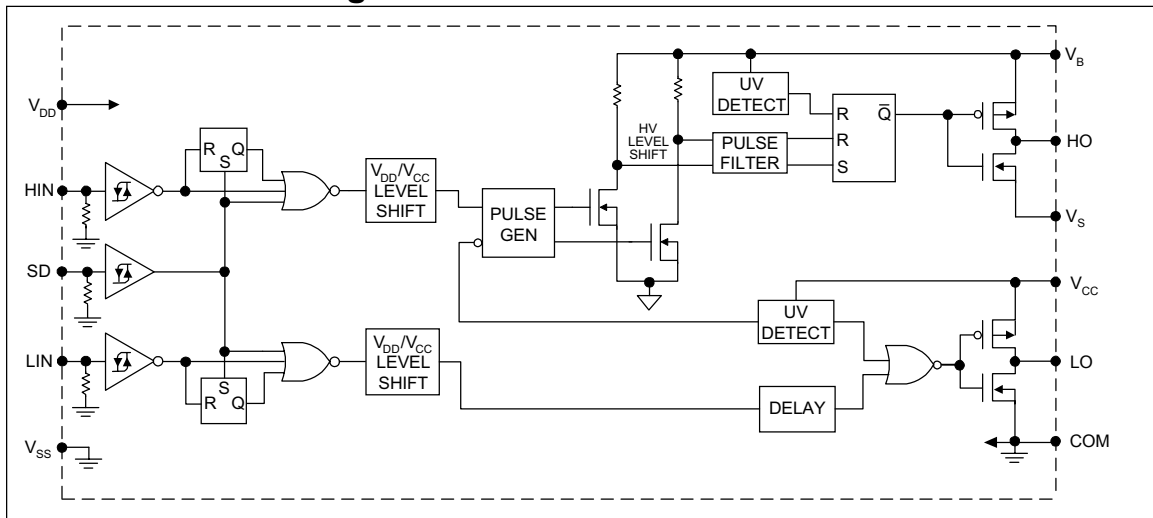

Lead Definitions

Symbol	Description
V _{DD}	Logic supply
HIN	Logic input for high side gate driver output (HO), in phase
SD	Logic input for shutdown
LIN	Logic input for low side gate driver output (LO), in phase
V _{SS}	Logic ground
V _B	High side floating supply
HO	High side gate drive output
V _S	High side floating supply return
V _{CC}	Low side supply
LO	Low side gate drive output
COM	Low side return

Lead Assignments

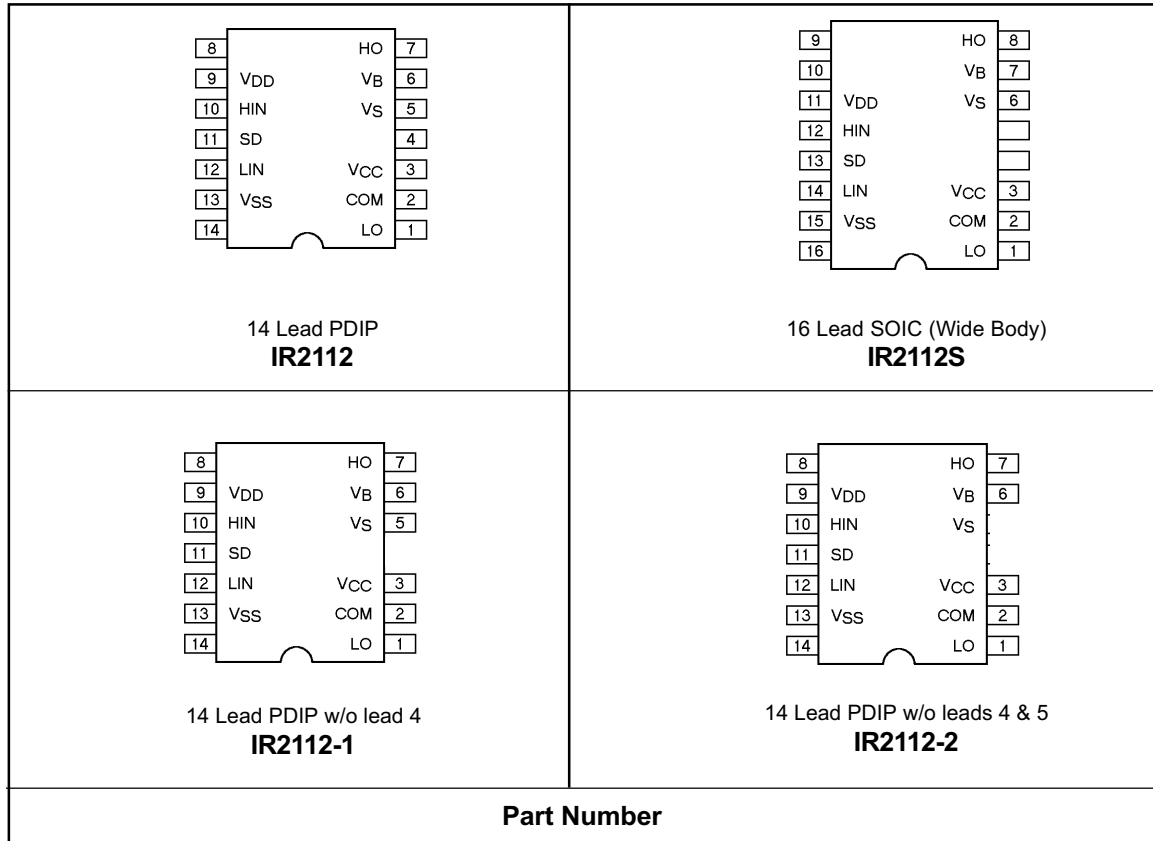

IR2112(-1-2)(S)PbF

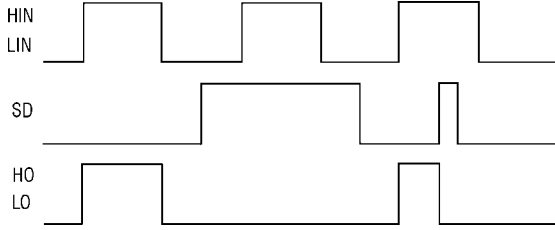

Figure 1. Input/Output Timing Diagram

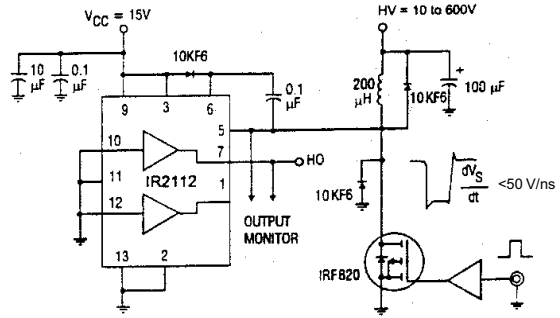

Figure 2. Floating Supply Voltage Transient Test Circuit

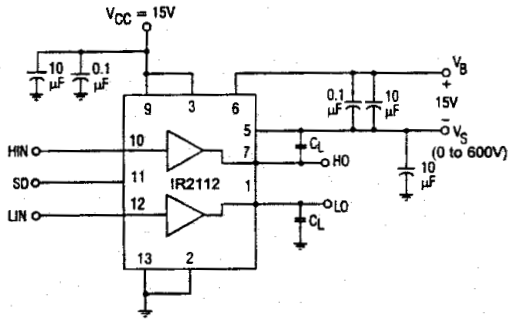

Figure 3. Switching Time Test Circuit

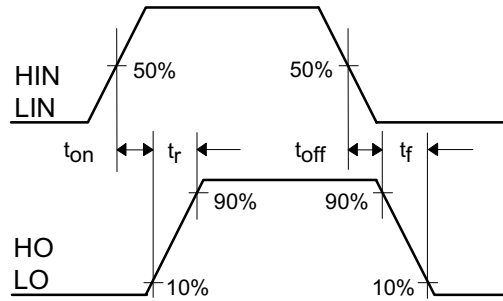

Figure 4. Switching Time Waveform Definition

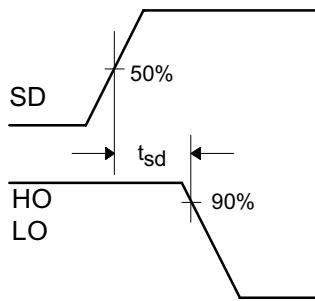

Figure 5. Shutdown Waveform Definitions

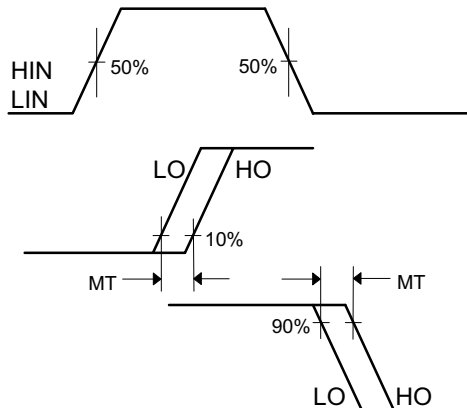

Figure 6. Delay Matching Waveform Definitions

IR2112(-1-2)(S)PbF

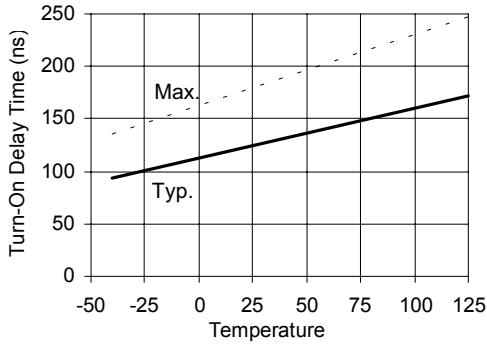

Figure 7A. Turn-On Time vs. Temperature

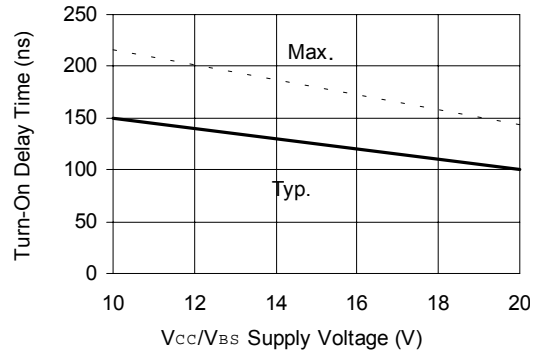

Figure 7B. Turn-On Time vs. V_{CC}/V_{BS} Supply Voltage

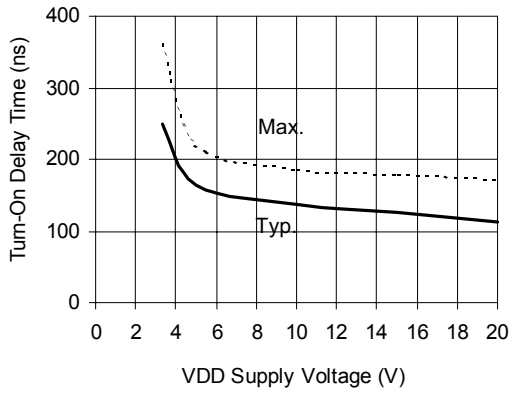

Figure 7C. Turn-On Time vs. V_{DD} Supply Voltage

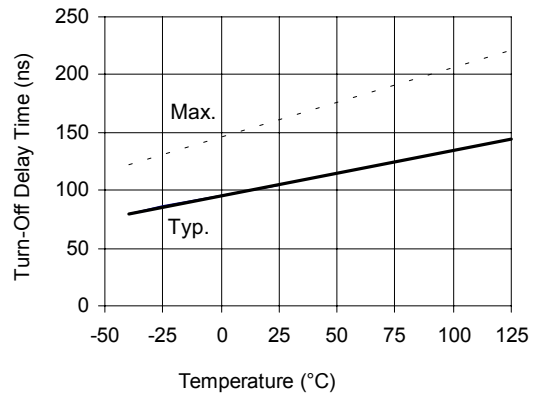

Figure 8A. Turn-Off Time vs. Temperature

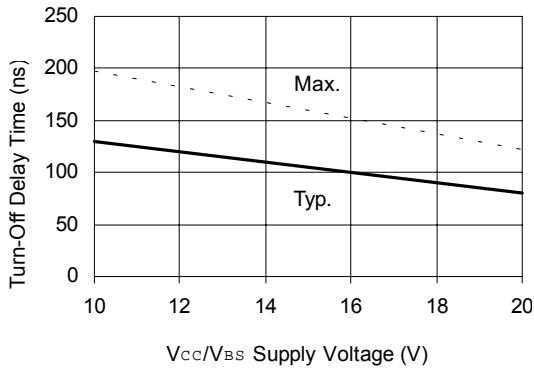

Figure 8B. Turn-Off Time vs. V_{CC}/V_{BS} Supply Voltage

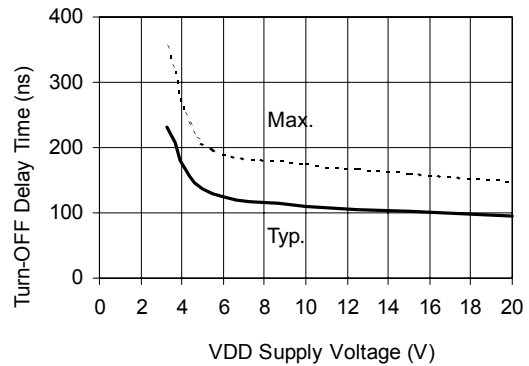

Figure 8C. Turn-Off Time vs. V_{DD} Supply Voltage

IR2112(-1-2)(S)PbF

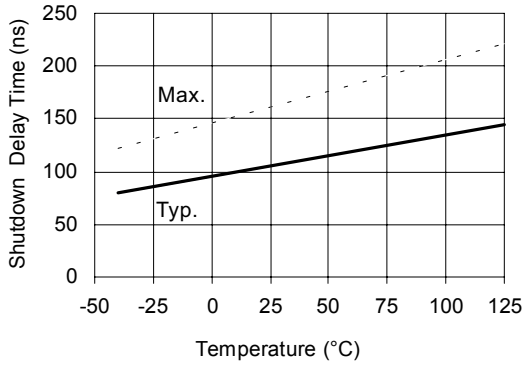

Figure 9A. Shutdown Time vs. Temperature

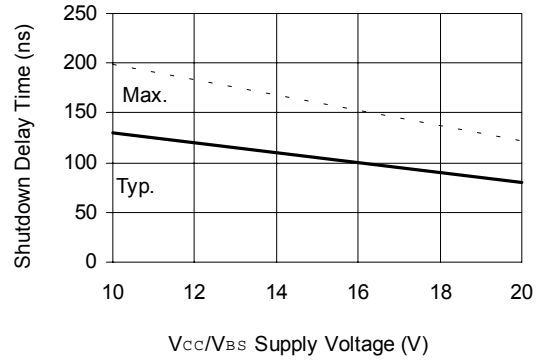

Figure 9B. Shutdown Delay Time vs. V_{cc}/V_{BS} Supply Voltage

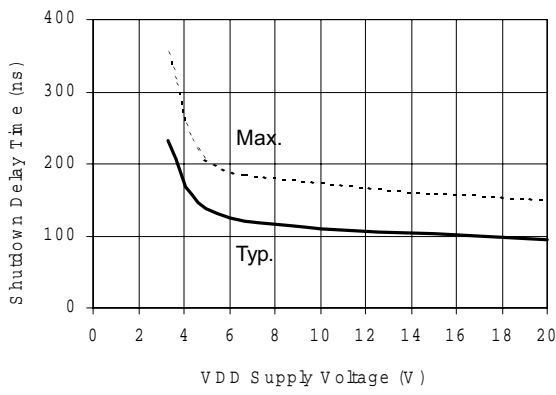

Figure 9C. Shutdown Time vs. V_{DD} Supply Voltage

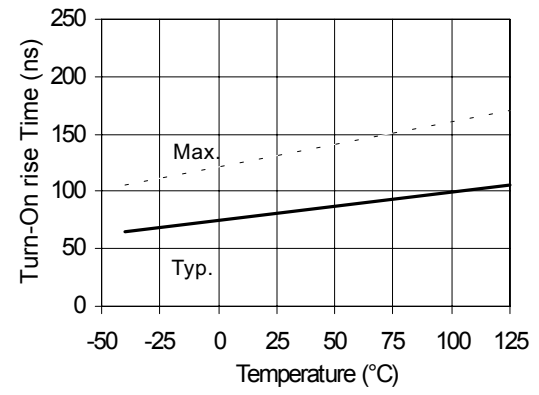

Figure 10A. Turn-On Rise Time vs. Temperature

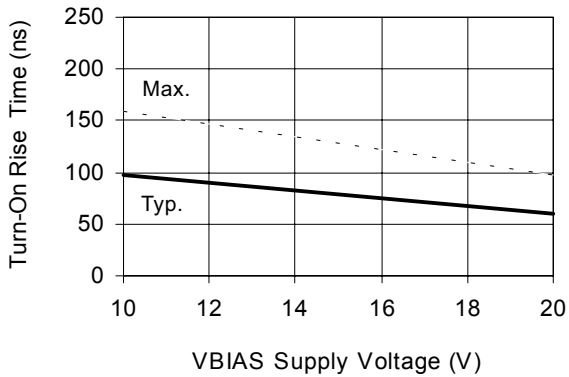

Figure 10B. Turn-On Rise Time vs. Voltage

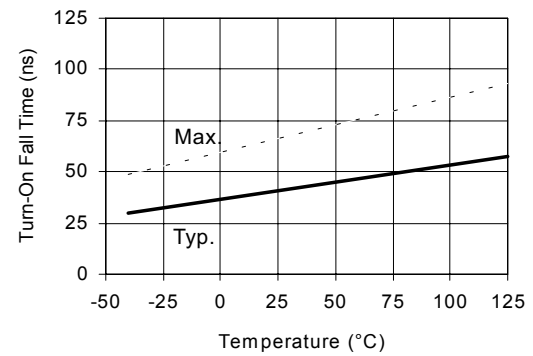

Figure 11A Turn-On Fall Time vs. Temperature

IR2112(-1-2)(S)PbF

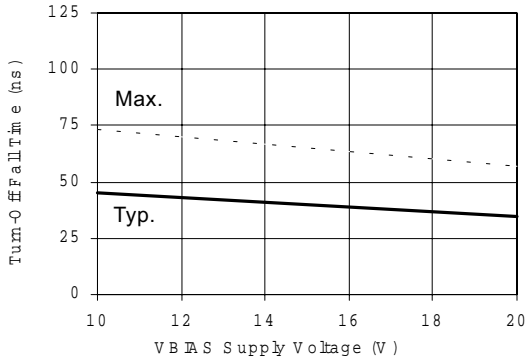

Figure 11B. Turn-Off Fall Time vs. Voltage

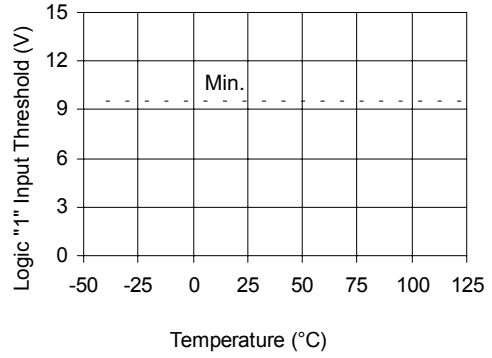

Figure 12A. Logic "1" Input Threshold vs. Temperature

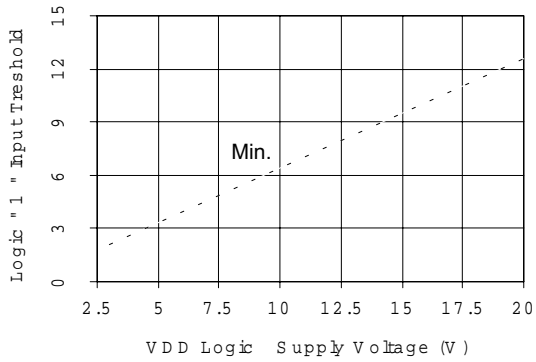

Figure 12B. Logic "1" Input Threshold vs. Voltage

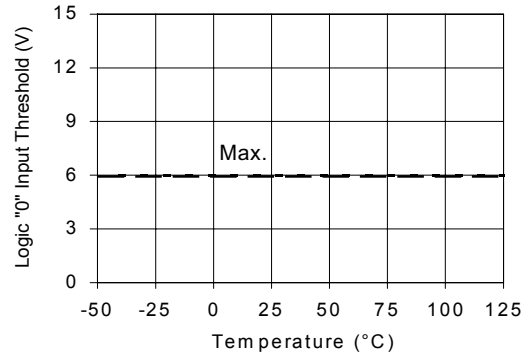

Figure 13A. Logic "0" Input Threshold vs. Temperature

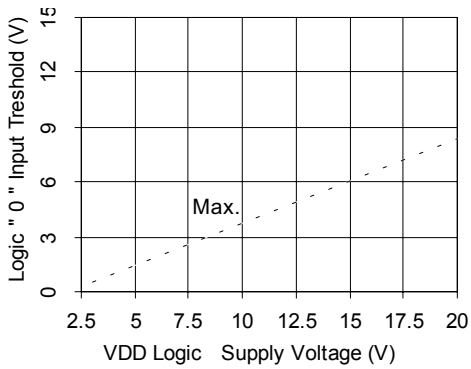

Figure 13B. Logic "0" Input Threshold vs. Voltage

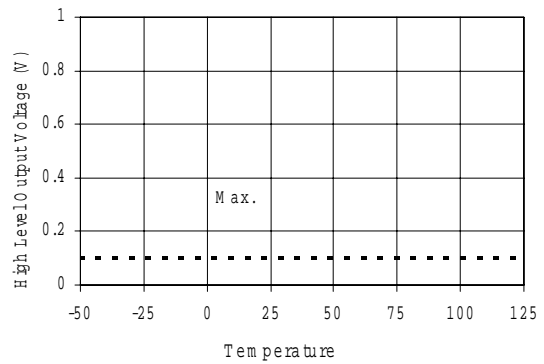

Figure 14A. High Level Output vs. Temperature

IR2112(-1-2)(S)PbF

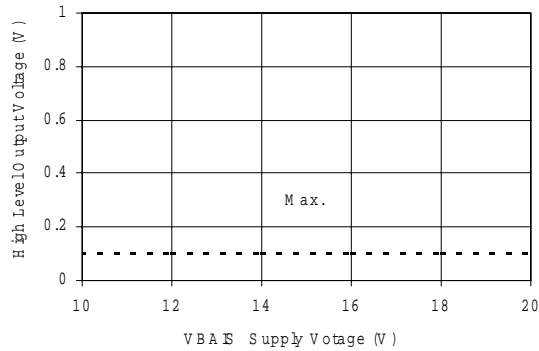

Figure 14B. High Level Output vs. Voltage

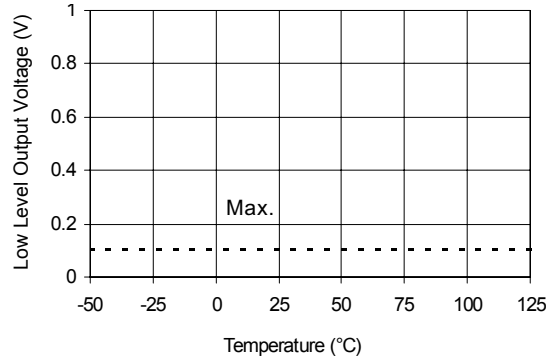

Figure 15A. Low Level Output vs. Temperature

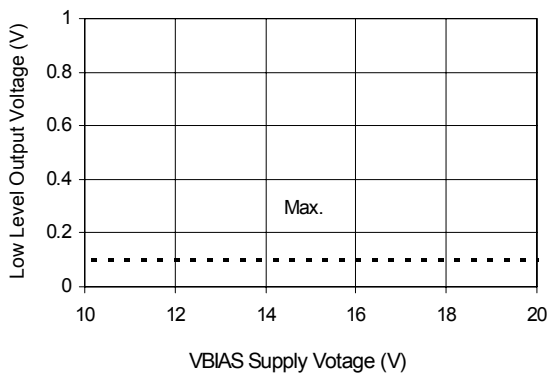

Figure 15B. Low Level Output vs. Voltage

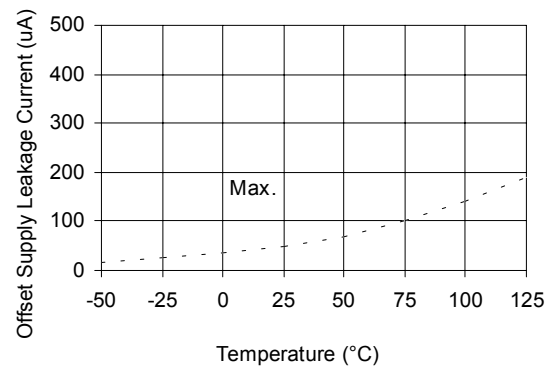

Figure 16A. Offset Supply Current vs. Temperature

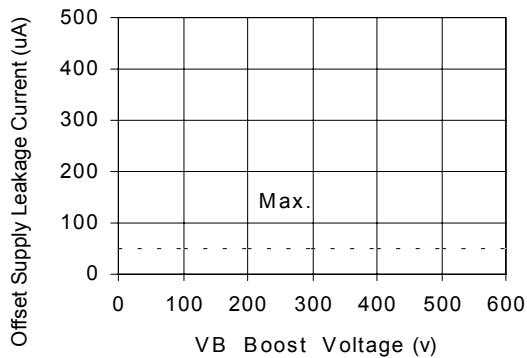

Figure 16B. Offset Supply Current vs. Voltage

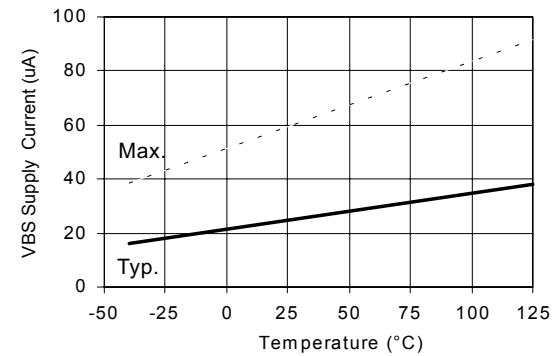

Figure 17A. Vbs Supply Current vs. Temperature

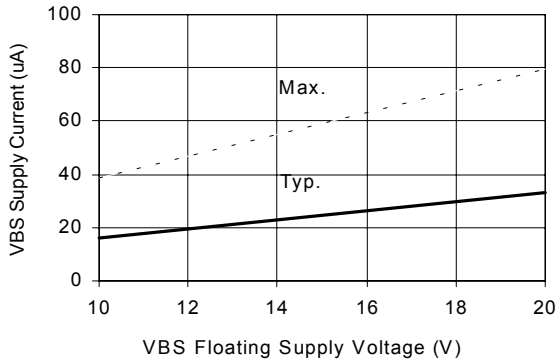

Figure 17B. VBS Supply Current vs. Voltage

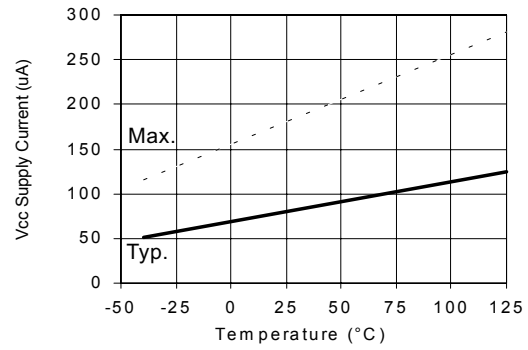

Figure 18A. VCC Supply Current vs. Temperature

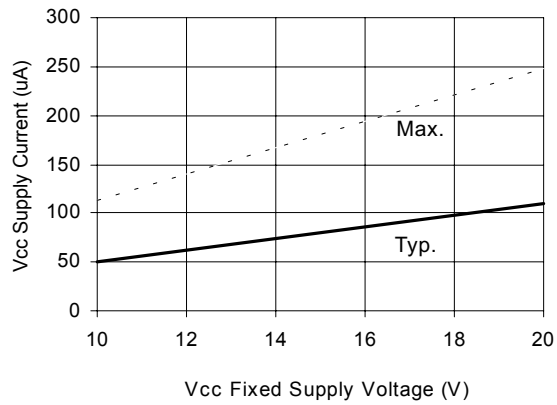

Figure 18B. VCC Supply Current vs. Voltage

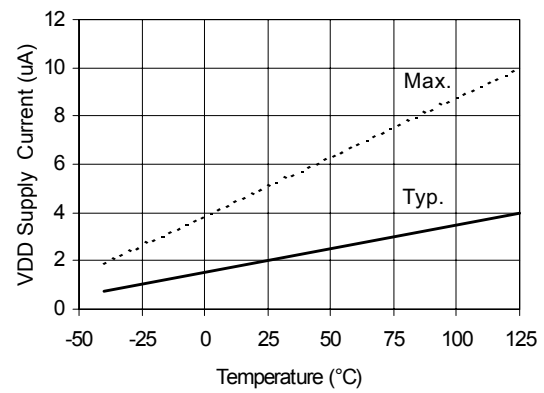

Figure 19A. VDD Supply Current vs. Temperature

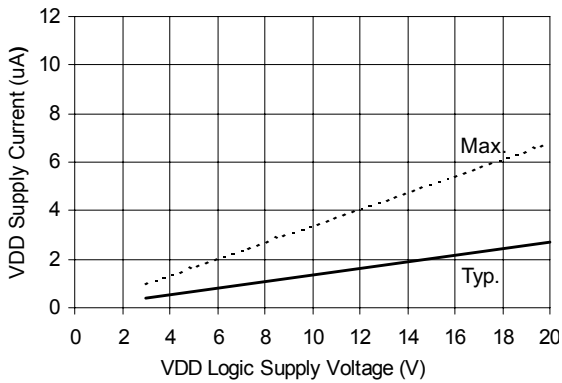

Figure 19B. VDD Supply Current vs. VDD Voltage

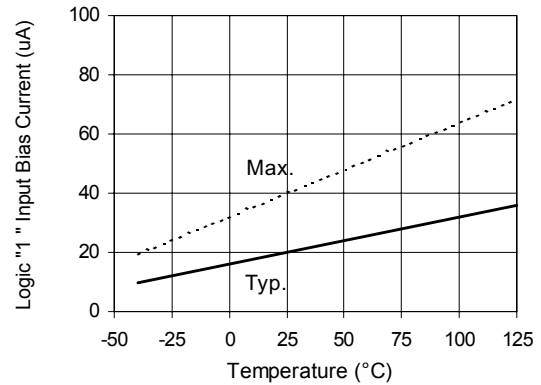

Figure 20A. Logic "1" Input Current vs. Temperature

IR2112(-1-2)(S)PbF

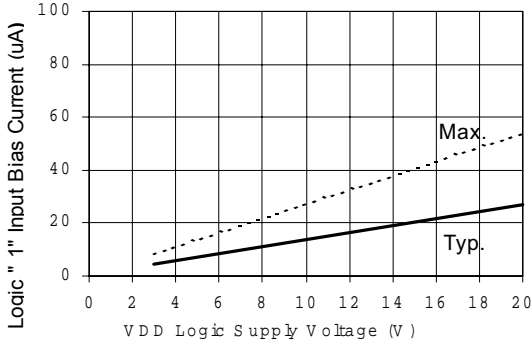

Figure 20B. Logic "1" Input Current vs. V_{DD} Voltage

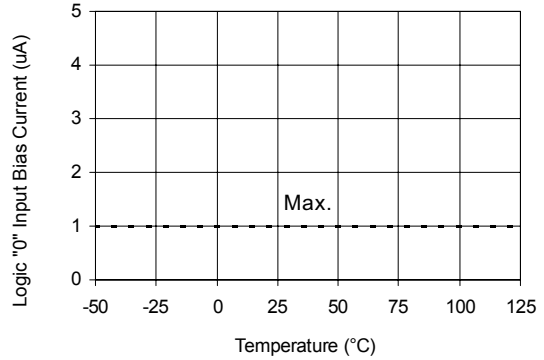

Figure 21A. Logic "0" Input Current vs. Temperature

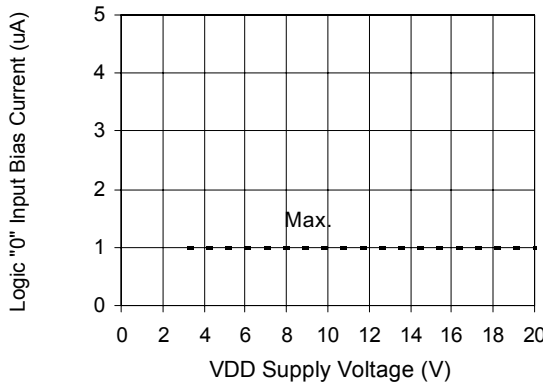

Figure 21B. Logic "0" Input Current vs. V_{DD} Voltage

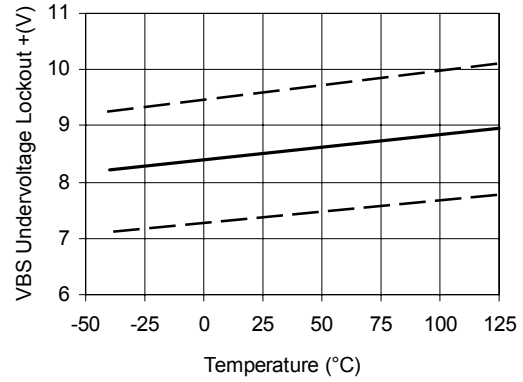

Figure 22. V_{bs} Undervoltage (+) vs. Temperature

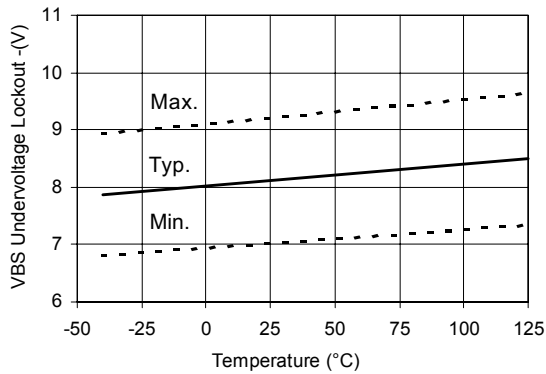

Figure 23. V_{bs} Undervoltage (-) vs. Temperature

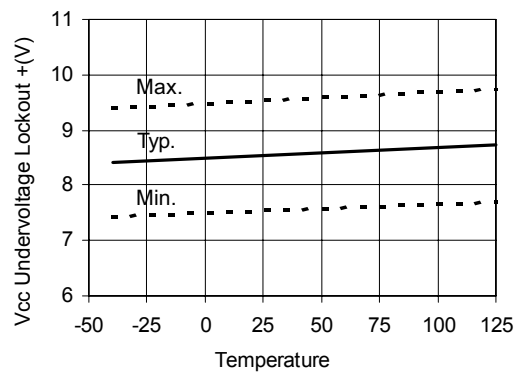

Figure 24. V_{cc} Undervoltage (-) vs. Temperature

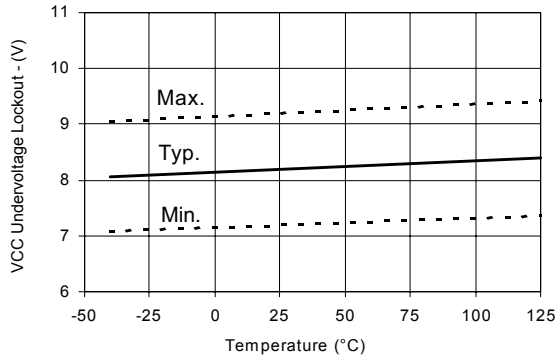

Figure 25. Vcc Undervoltage (-) vs. Temperature

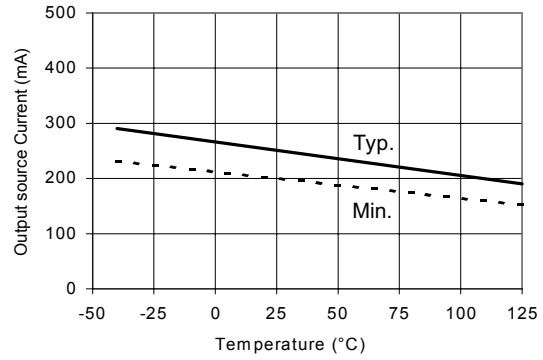

Figure 26A. Output Source Current vs. Temperature

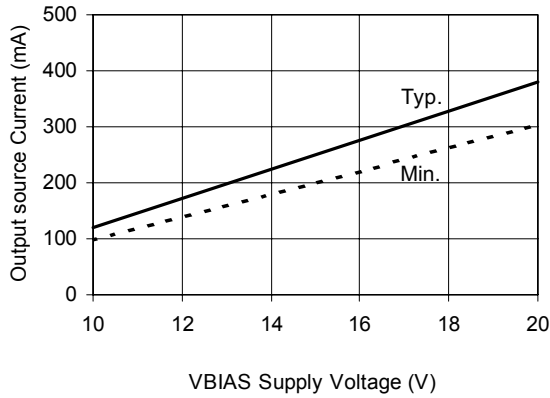

Figure 26B. Output Source Current vs. Voltage

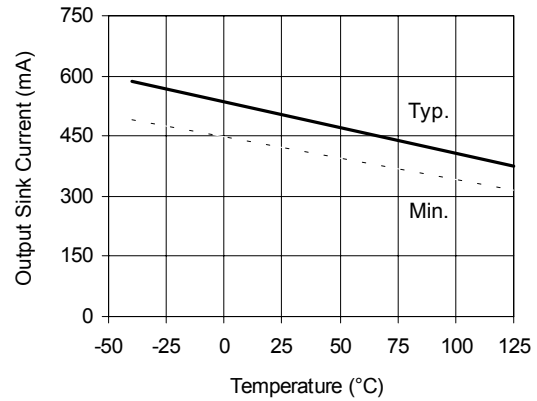

Figure 27A. Output Sink Current vs. Temperature

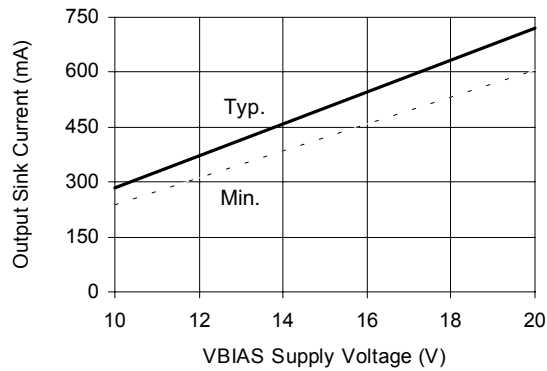

Figure 27B. Output Sink Current vs. Voltage

IR2112(-1-2)(S)PbF

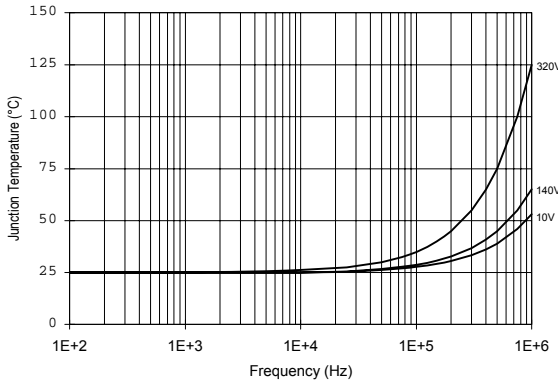

Figure 28. IR2112 T_J vs. Frequency (IRFBC20)
R_{GATE} = 33Ω, V_{CC} = 15V

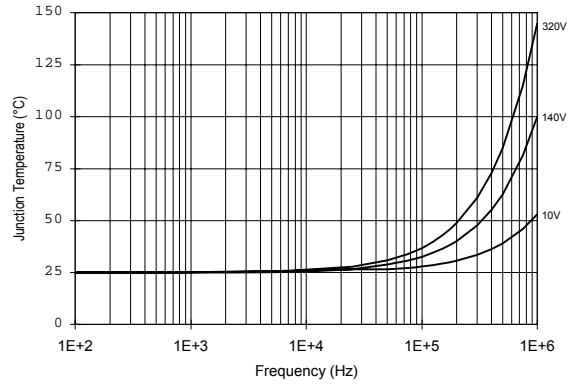

Figure 29. IR2112 T_J vs. Frequency (IRFBC30)
R_{GATE} = 22Ω, V_{CC} = 15V

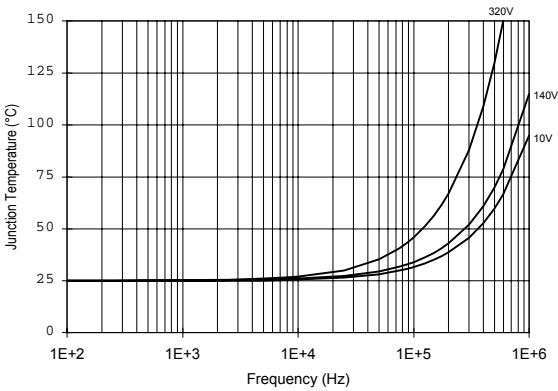

Figure 30. IR2112 T_J vs. Frequency (IRFBC40)
R_{GATE} = 15Ω, V_{CC} = 15V

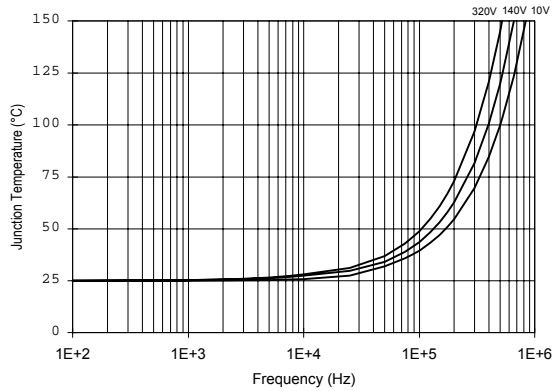

Figure 31. IR2112 T_J vs. Frequency (IRFPE50)
R_{GATE} = 10Ω, V_{CC} = 15V

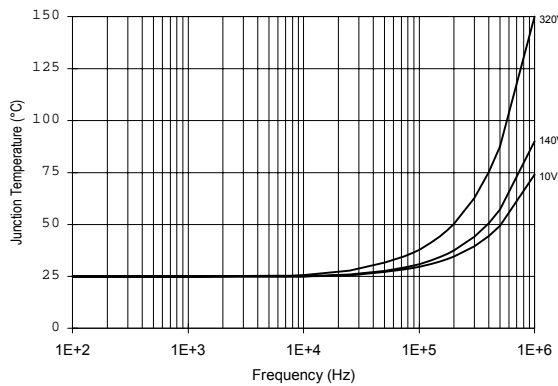

Figure 32. IR2112S T_J vs. Frequency (IRFBC20)
R_{GATE} = 33Ω, V_{CC} = 15V

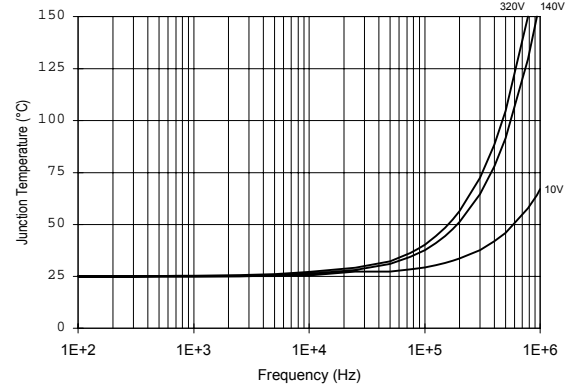

Figure 33. IR2112S T_J vs. Frequency (IRFBC30)
R_{GATE} = 22Ω, V_{CC} = 15V

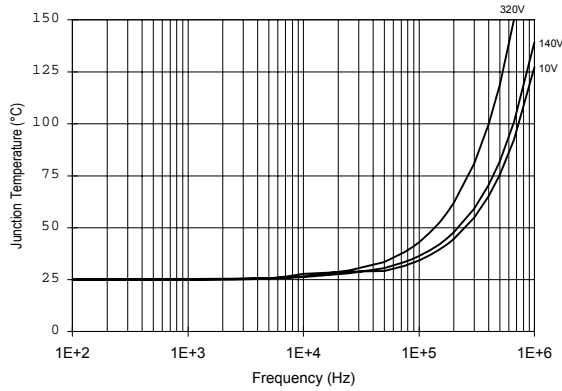

Figure 34. IR2112S T_J vs. Frequency (IRFBC40)
R_{GATE} = 15Ω, V_{CC} = 15V

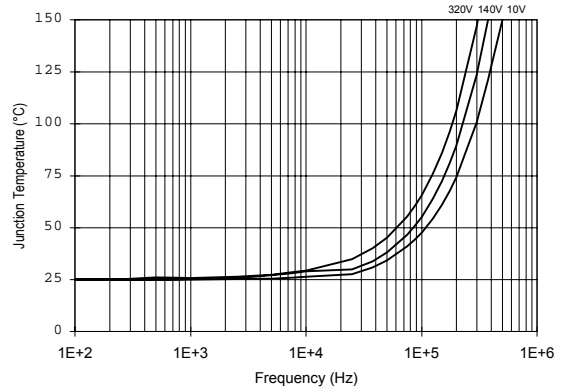

Figure 35. IR2112S T_J vs. Frequency (IRFPE50)
R_{GATE} = 10Ω, V_{CC} = 15V

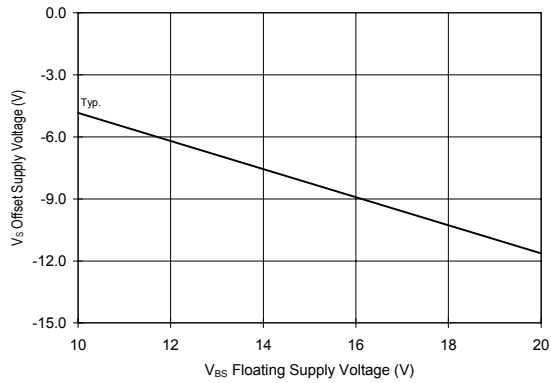

Figure 36. Maximum Vs Negative Offset vs. V_{BS} Supply Voltage

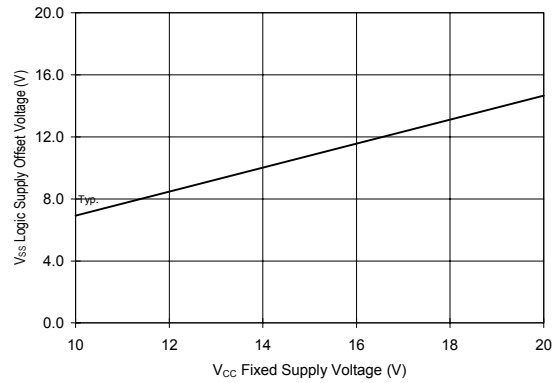
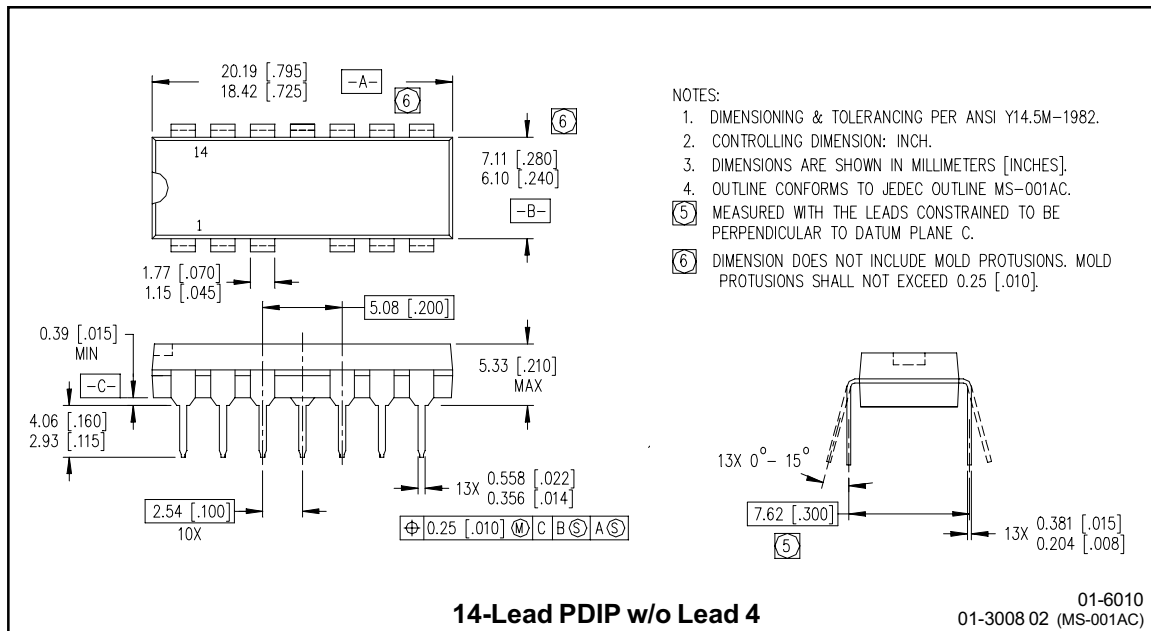
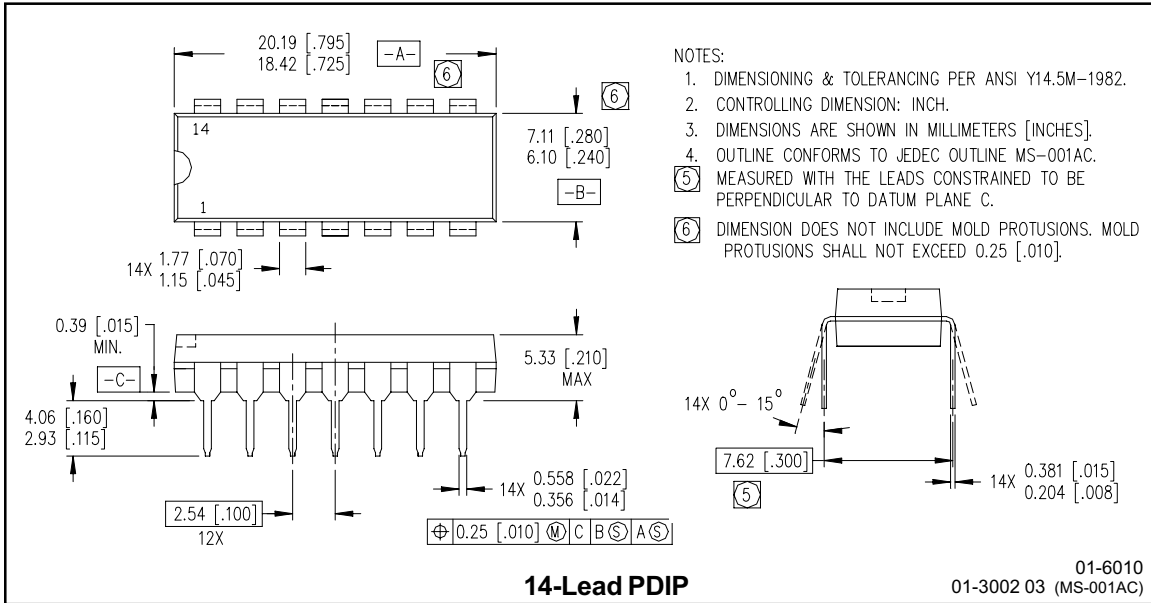

Figure 37. Maximum V_{SS} Positive Offset vs. V_{CC} Supply Voltage

IR2112(-1-2)(S)PbF

International
IR Rectifier

Case outline



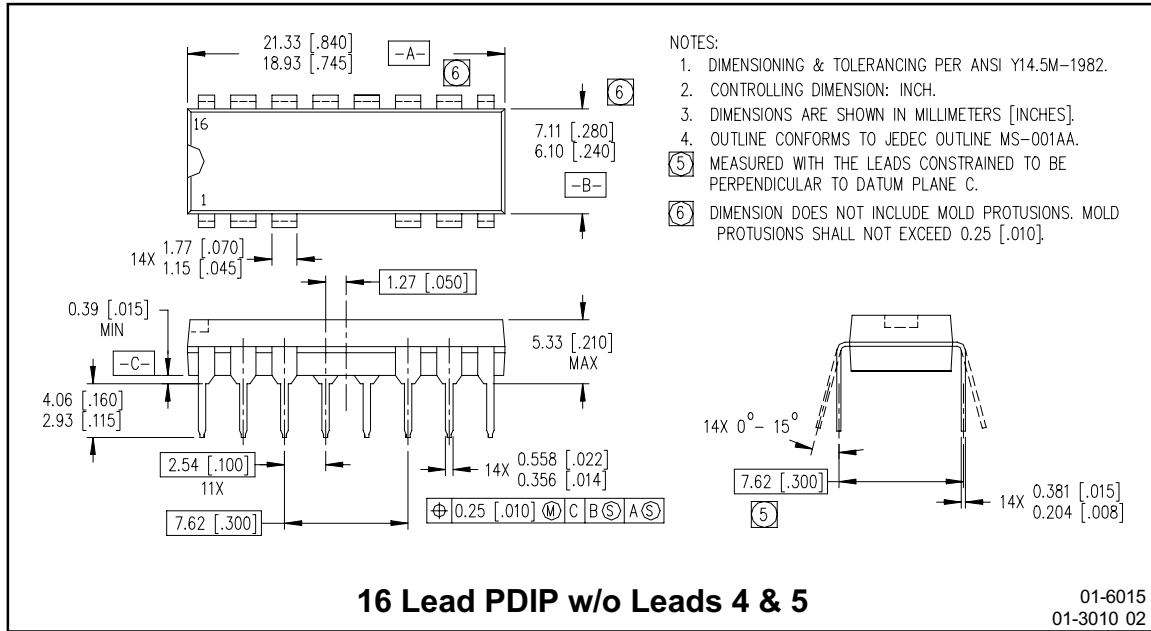

- NOTES:
1. DIMENSIONING & TOLERANCING PER ANSI Y14.5M-1982.
 2. CONTROLLING DIMENSION: INCH.
 3. DIMENSIONS ARE SHOWN IN MILLIMETERS [INCHES].
 4. OUTLINE CONFORMS TO JEDEC OUTLINE MS-001AA.
 - ⑤ MEASURED WITH THE LEADS CONSTRAINED TO BE PERPENDICULAR TO DATUM PLANE C.
 - ⑥ DIMENSION DOES NOT INCLUDE MOLD PROTUSIONS. MOLD PROTUSIONS SHALL NOT EXCEED 0.25 [.010].

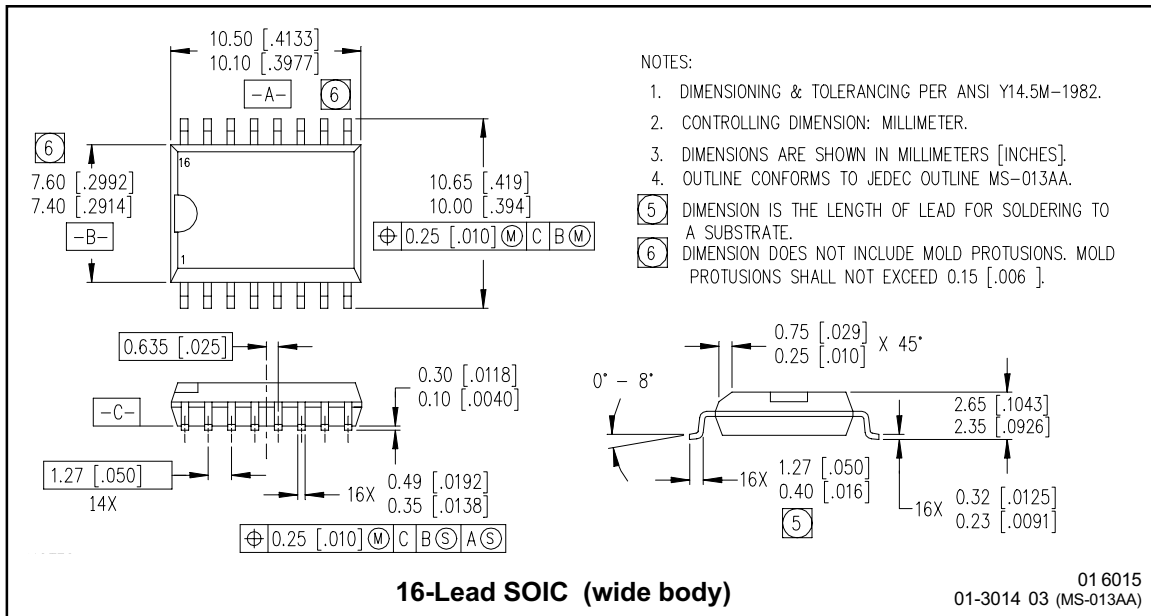

- NOTES:
1. DIMENSIONING & TOLERANCING PER ANSI Y14.5M-1982.
 2. CONTROLLING DIMENSION: MILLIMETER.
 3. DIMENSIONS ARE SHOWN IN MILLIMETERS [INCHES].
 4. OUTLINE CONFORMS TO JEDEC OUTLINE MS-013AA.
 - ⑤ DIMENSION IS THE LENGTH OF LEAD FOR SOLDERING TO A SUBSTRATE.
 - ⑥ DIMENSION DOES NOT INCLUDE MOLD PROTUSIONS. MOLD PROTUSIONS SHALL NOT EXCEED 0.15 [.006].

IR2112(-1-2)(S)PbF

International
IR Rectifier

LEADFREE PART MARKING INFORMATION

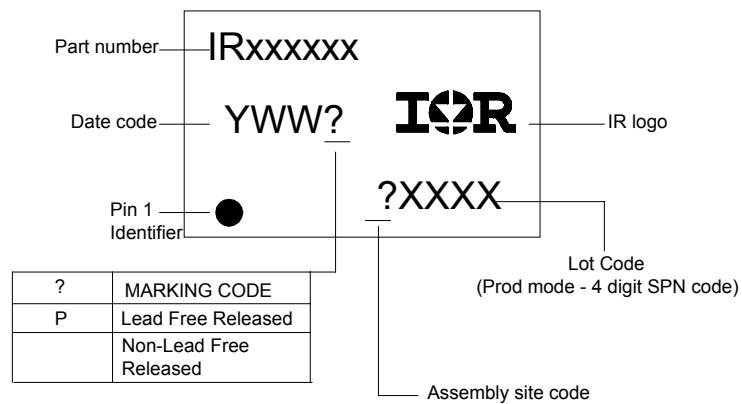

ORDER INFORMATION

Part only available Leadfree

14-Lead PDIP IR2112 order IR2112PbF
14-Lead PDIP IR2112-1 order IR2112-1PbF
14-Lead PDIP IR2112-2 order IR2112-2PbF
16-Lead SOIC IR2112S order IR2112SPbF

International
IR Rectifier

IR WORLD HEADQUARTERS: 233 Kansas St., El Segundo, California 90245 Tel: (310) 252-7105

This product has been qualified per industrial level

Data and specifications subject to change without notice. 3/23/2005