

TLE214x, TLE214xA, TLE214xY EXCALIBUR LOW-NOISE HIGH-SPEED PRECISION OPERATIONAL AMPLIFIERS

SLOS183A – FEBRUARY 1997 – REVISED MARCH 1998

- **Low Noise**
10 Hz . . . 15 nV/ $\sqrt{\text{Hz}}$
1 kHz . . . 10.5 nV/ $\sqrt{\text{Hz}}$
- **10000-pF Load Capability**
- **20-mA Min Short-Circuit Output Current**
- **27-V/ μs Min Slew Rate**
- **High Gain-Bandwidth Product . . . 5.9 MHz**
- **Low V_{IO} . . . 500 μV Max at 25°C**
- **Single or Split Supply . . . 4 V to 44 V**
- **Fast Settling Time**
340 ns to 0.1%
400 ns to 0.01%
- **Saturation Recovery . . . 150 ns**
- **Large Output Swing**
 $V_{CC-} + 0.1 \text{ V}$ to $V_{CC+} - 1 \text{ V}$

description

The TLE214x and TLE214xA devices are high-performance, internally compensated operational amplifiers built using Texas Instruments complementary bipolar Excalibur process. The TLE214xA is a tighter offset voltage grade of the TLE214x. Both are pin-compatible upgrades to standard industry products.

The design incorporates an input stage that simultaneously achieves low audio-band noise of 10.5 nV/ $\sqrt{\text{Hz}}$ with a 10-Hz 1/f corner and symmetrical 40-V/ μs slew rate typically with loads up to 800 pF. The resulting low distortion and high power bandwidth are important in high-fidelity audio applications. A fast settling time of 340 ns to 0.1% of a 10-V step with a 2-k Ω /100-pF load is useful in fast actuator/positioning drivers. Under similar test conditions, settling time to 0.01% is 400 ns.

The devices are stable with capacitive loads up to 10 nF, although the 6-MHz bandwidth decreases to 1.8 MHz at this high loading level. As such, the TLE214x and TLE214xA are useful for low-droop sample-and-holds and direct buffering of long cables, including 4-mA to 20-mA current loops.

The special design also exhibits an improved insensitivity to inherent integrated circuit component mismatches as is evidenced by a 500- μV maximum offset voltage and 1.7- $\mu\text{V}/^\circ\text{C}$ typical drift. Minimum common-mode rejection ratio and supply-voltage rejection ratio are 85 dB and 90 dB, respectively.

Device performance is relatively independent of supply voltage over the $\pm 2\text{-V}$ to $\pm 22\text{-V}$ range. Inputs can operate between $V_{CC-} - 0.3$ to $V_{CC+} - 1.8 \text{ V}$ without inducing phase reversal, although excessive input current may flow out of each input exceeding the lower common-mode input range. The all-npn output stage provides a nearly rail-to-rail output swing of $V_{CC-} - 0.1$ to $V_{CC+} - 1 \text{ V}$ under light current-loading conditions. The device can sustain shorts to either supply since output current is internally limited, but care must be taken to ensure that maximum package power dissipation is not exceeded.

Both versions can also be used as comparators. Differential inputs of $V_{CC\pm}$ can be maintained without damage to the device. Open-loop propagation delay with TTL supply levels is typically 200 ns. This gives a good indication as to output stage saturation recovery when the device is driven beyond the limits of recommended output swing.

Both the TLE214x and TLE214xA are available in a wide variety of packages, including both the industry-standard 8-pin small-outline version and chip form for high-density system applications. The C-suffix devices are characterized for operation from 0°C to 70°C, I-suffix devices from -40°C to 105°C, and M-suffix devices over the full military temperature range of -55°C to 125°C.



Please be aware that an important notice concerning availability, standard warranty, and use in critical applications of Texas Instruments semiconductor products and disclaimers thereto appears at the end of this data sheet.

PRODUCTION DATA information is current as of publication date. Products conform to specifications per the terms of Texas Instruments standard warranty. Production processing does not necessarily include testing of all parameters.

 **TEXAS
INSTRUMENTS**

POST OFFICE BOX 655303 • DALLAS, TEXAS 75265

Copyright © 1998, Texas Instruments Incorporated

TLE214x, TLE214xA, TLE214xY EXCALIBUR LOW-NOISE HIGH-SPEED PRECISION OPERATIONAL AMPLIFIERS

SLOS183A – FEBRUARY 1997 – REVISED MARCH 1998

TLE2141 AVAILABLE OPTIONS

T _A	V _{IO} max AT 25°C	PACKAGED DEVICES				CHIP FORM‡ (Y)
		SMALL OUT- LINE† (D)	CHIP CARRIER (FK)	CERAMIC DIP (JG)	PLASTIC DIP (P)	
0°C to 70°C	500 μV 900 μV	TLE2141ACD TLE2141CD	—	—	TLE2141ACP TLE2141CP	—
–40°C to 105°C	500 μV 900 μV	TLE2141AID TLE2141ID	—	—	TLE2141AIP TLE2141IP	TLE2141Y
–55°C to 125°C	500 μV 900 μV	TLE2141AMD TLE2141MD	TLE2141AMFK TLE2141MFK	TLE2141AMJG TLE2141MJG	TLE2141AMP TLE2141MP	—

† The D packages are available taped and reeled. Add R suffix to device type (e.g., TLE2141ACDR).

‡ Chip forms are tested at T_A = 25°C only.

TLE2142 AVAILABLE OPTIONS

T _A	V _{IO} max AT 25°C	PACKAGED DEVICES					CHIP FORM§ (Y)
		SMALL OUTLINE† (D)	CHIP CARRIER (FK)	CERAMIC DIP (JG)	PLASTIC DIP (P)	TSSOP† (PW)	
0°C to 70°C	750 μV 1200 μV	TLE2142ACD TLE2142CD	— —	— —	TLE2142ACP TLE2142CP	— TLE2142CPWLE	—
–40°C to 105°C	750 μV 1200 μV	TLE2142AID TLE2142ID	— —	— —	TLC2142AIP TLC2142IP	— —	TLE2142Y
–55°C to 125°C	750 μV 1200 μV	TLE2142AMD TLE2142MD	TLE2142AMFK TLE2142MFK	TLE2142AMJG TLE2142MJG	TLC2142AMP TLC2142MP	— —	—

† The D packages are available taped and reeled. Add R suffix to device type (e.g., TLC2142ACDR).

‡ The PW packages are available left-ended taped and reeled. Add LE the suffix to device type (e.g., TLC2142CPWLE).

§ Chip forms are tested at T_A = 25°C only.

TLE2144 AVAILABLE OPTIONS

T _A	V _{IO} max AT 25°C	PACKAGED DEVICES				CHIP FORM‡ (Y)
		SMALL OUTLINE† (DW)	CHIP CARRIER (FK)	CERAMIC DIP (J)	PLASTIC DIP (N)	
0°C to 70°C	1.5 mV 2.4 mV	— TLE2144CDW	— —	— —	TLE2144ACN TLE2144CN	—
–40°C to 105°C	1.5 mV 2.4 mV	— TLE2144IDW	— —	— —	TLE2144AIN TLE2144IN	TLE2144Y
–55°C to 125°C	1.5 mV 2.5 mV	— TLE2144MDW	TLE2144AMFK TLE2144MFK	TLE2144AMJ TLE2144MJ	TLE2144AMN TLE2144MN	—

† The DW packages are available taped and reeled. Add R suffix to device type (e.g., TLE2144CDWR).

‡ Chip forms are tested at T_A = 25°C only.



TLE214x, TLE214xA, TLE214xY EXCALIBUR LOW-NOISE HIGH-SPEED PRECISION OPERATIONAL AMPLIFIERS

SLOS183A – FEBRUARY 1997 – REVISED MARCH 1998

TLE2141
D, JG, OR P PACKAGE
(TOP VIEW)

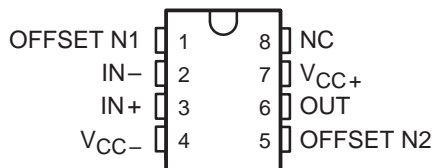

TLE2142
PW PACKAGE
(TOP VIEW)

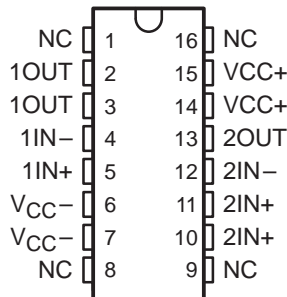

TLE2142
D, JG, OR P PACKAGE
(TOP VIEW)

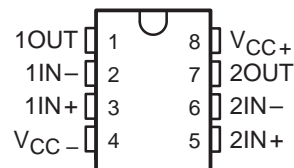

TLE2141
FK PACKAGE
(TOP VIEW)

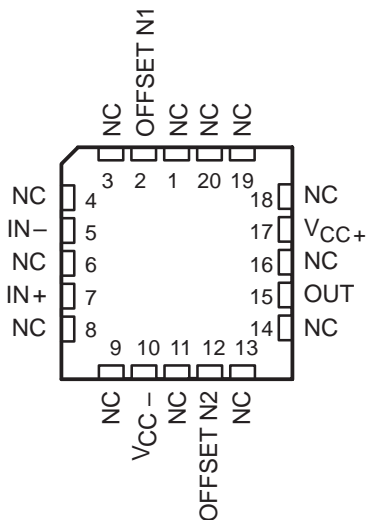

TLE2142
FK PACKAGE
(TOP VIEW)

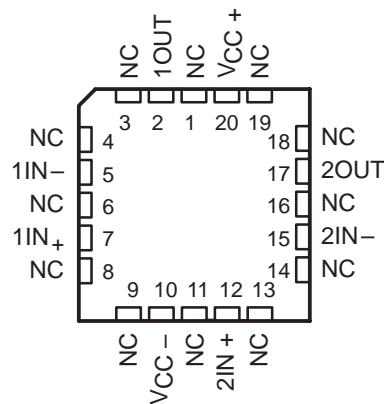

TLE2144
DW PACKAGE
(TOP VIEW)

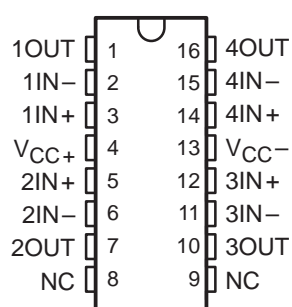

TLE2144
J OR N PACKAGE
(TOP VIEW)

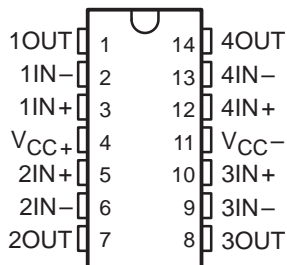

TLE2144
FK PACKAGE
(TOP VIEW)

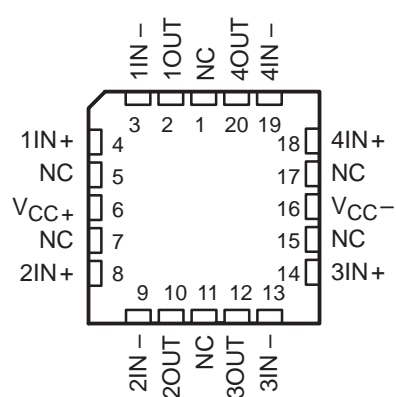

NC – No internal connection

TLE214x, TLE214xA, TLE214xY EXCALIBUR LOW-NOISE HIGH-SPEED PRECISION OPERATIONAL AMPLIFIERS

SLOS183A – FEBRUARY 1997 – REVISED MARCH 1998

symbol

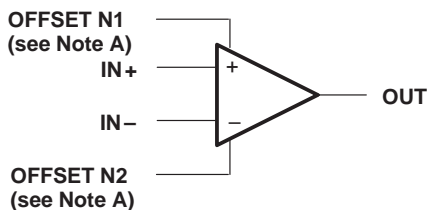

NOTES: A. OFFSET N1 AND OFFSET N2 are only available on the TLE2241x devices.

TLE2141Y chip information

This chip, when properly assembled, displays characteristics similar to the TLE2141. Thermal compression or ultrasonic bonding may be used on the doped-aluminum bonding pads. Chips may be mounted with conductive epoxy or a gold-silicon preform.

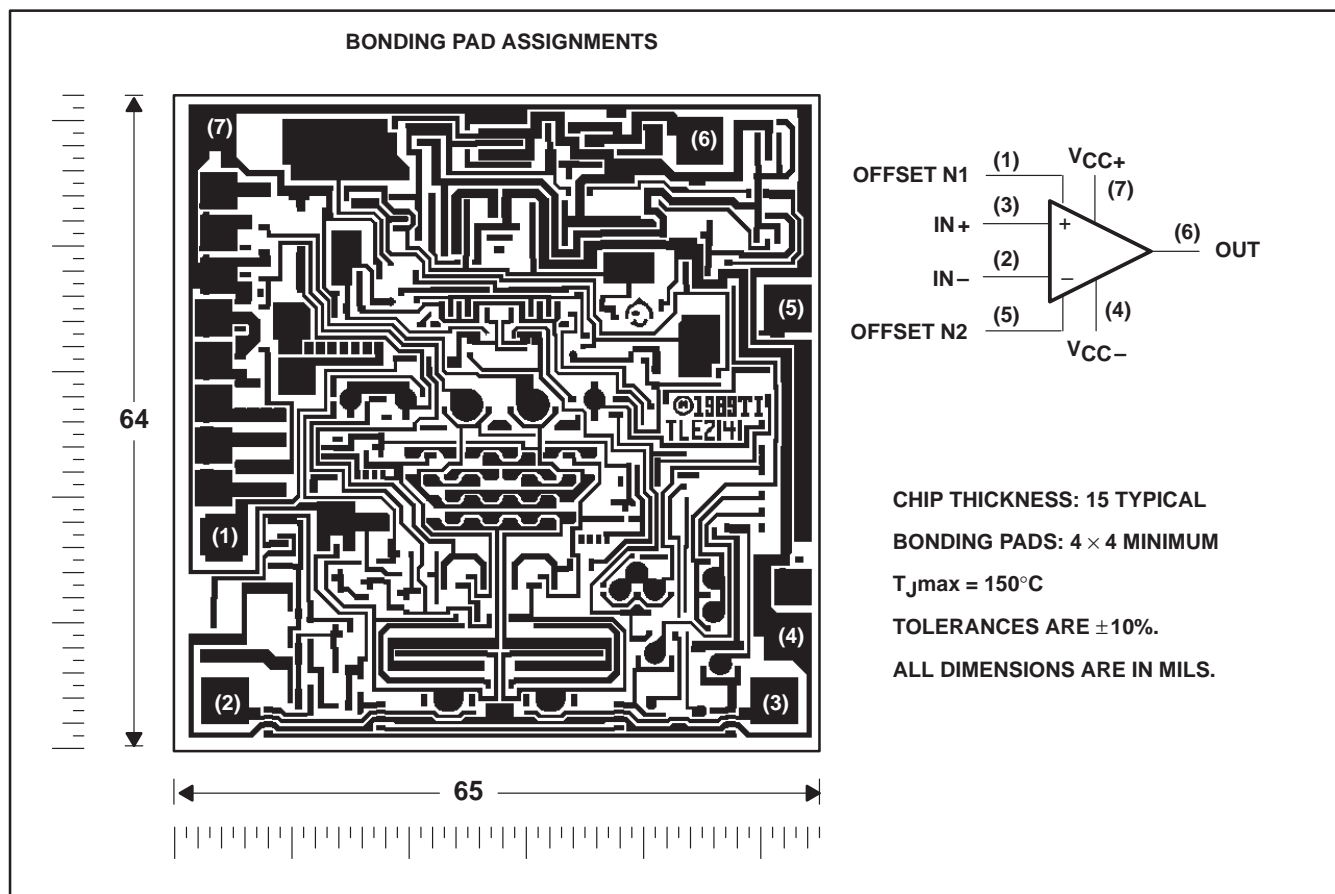

TLE214x, TLE214xA, TLE214xY EXCALIBUR LOW-NOISE HIGH-SPEED PRECISION OPERATIONAL AMPLIFIERS

SLOS183A – FEBRUARY 1997 – REVISED MARCH 1998

TLE2142Y chip information

This chip, when properly assembled, displays characteristics similar to the TLE2142. Thermal compression or ultrasonic bonding may be used on the doped-aluminum bonding pads. Chips may be mounted with conductive epoxy or a gold-silicon preform.

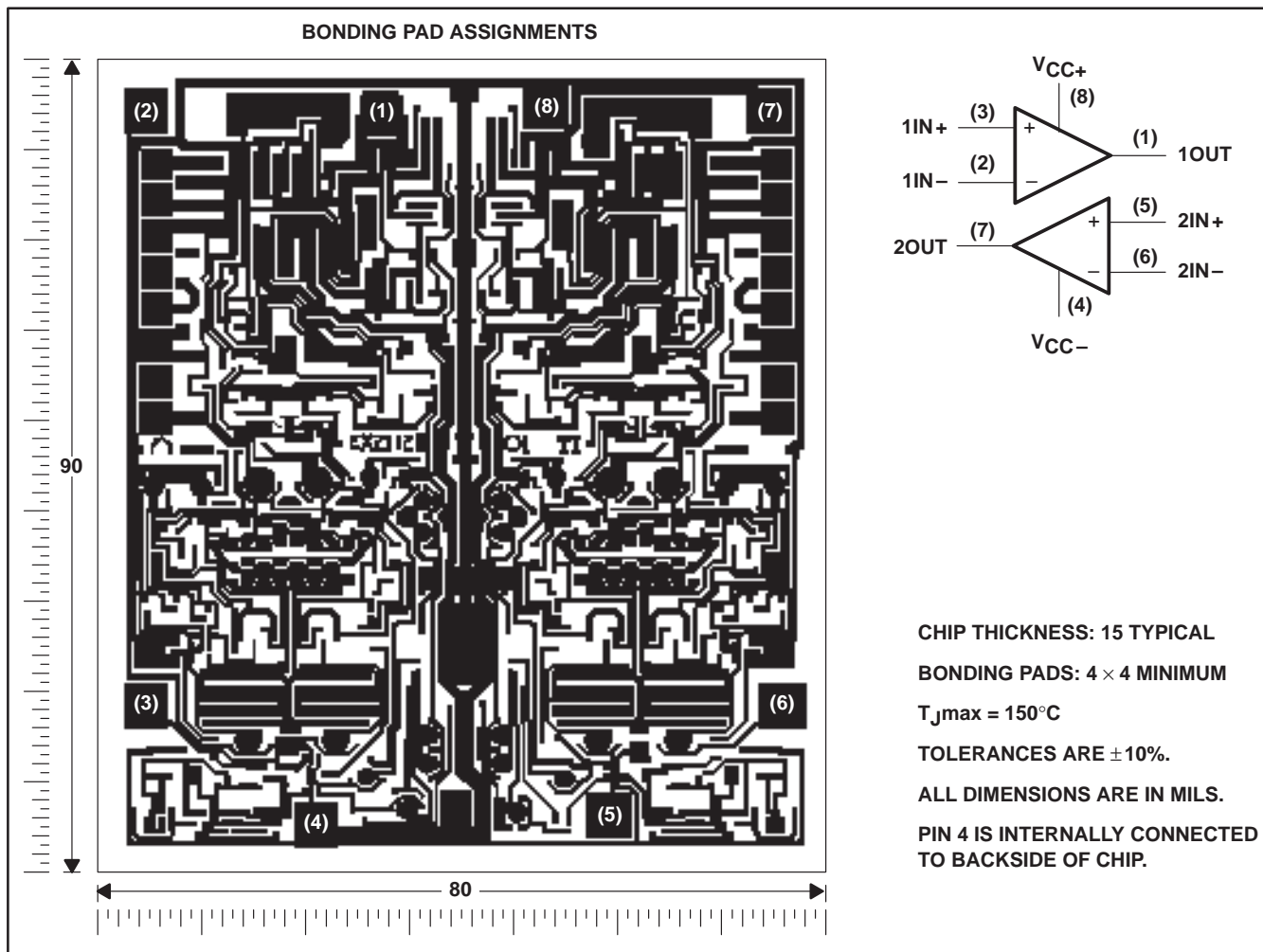

TLE214x, TLE214xA, TLE214xY
EXCALIBUR LOW-NOISE HIGH-SPEED
PRECISION OPERATIONAL AMPLIFIERS

SLOS183A – FEBRUARY 1997 – REVISED MARCH 1998

TLE2144Y chip information

This chip, when properly assembled, displays characteristics similar to the TLE2144. Thermal compression or ultrasonic bonding may be used on the doped-aluminum bonding pads. Chips may be mounted with conductive epoxy or a gold-silicon preform.

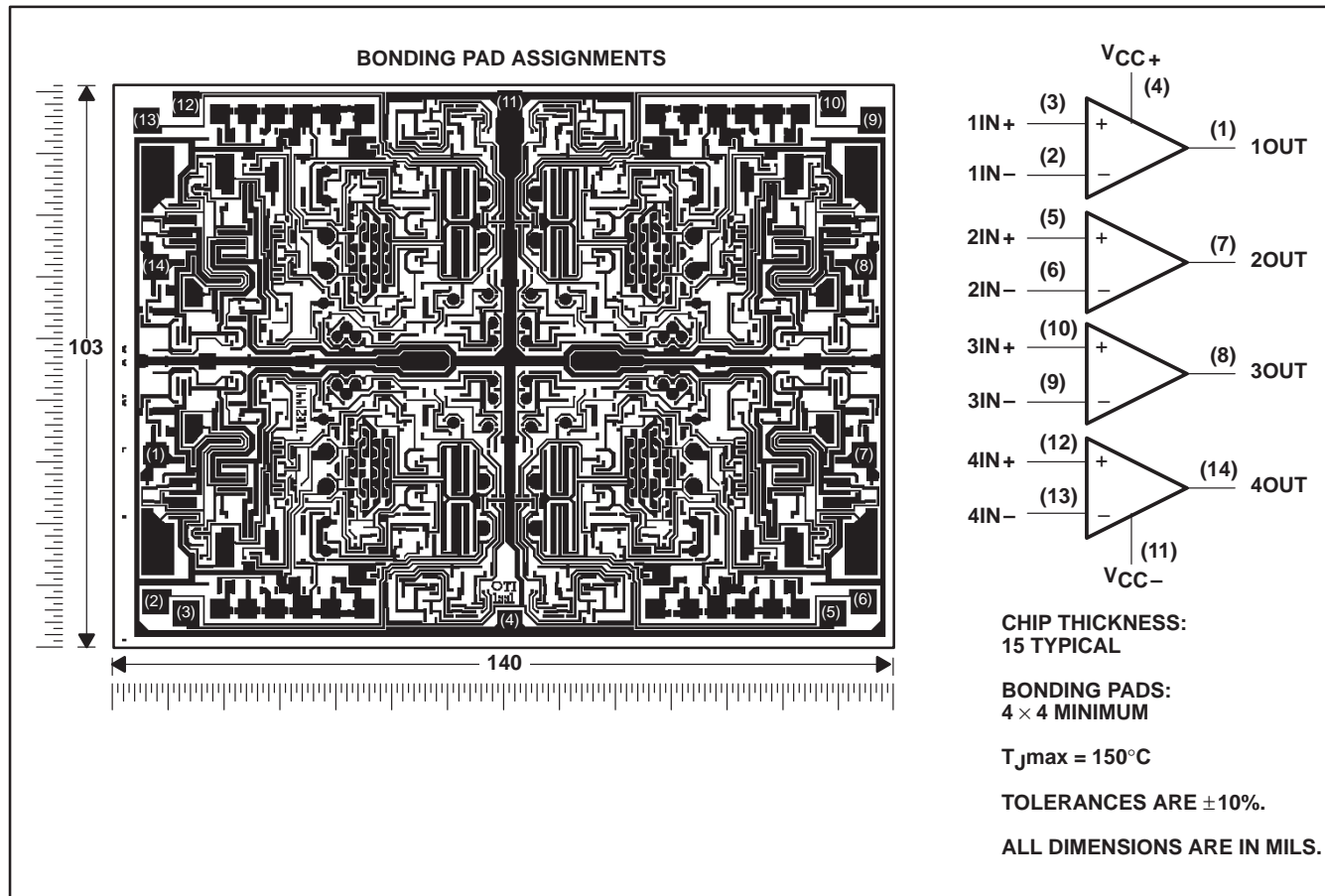

equivalent schematic

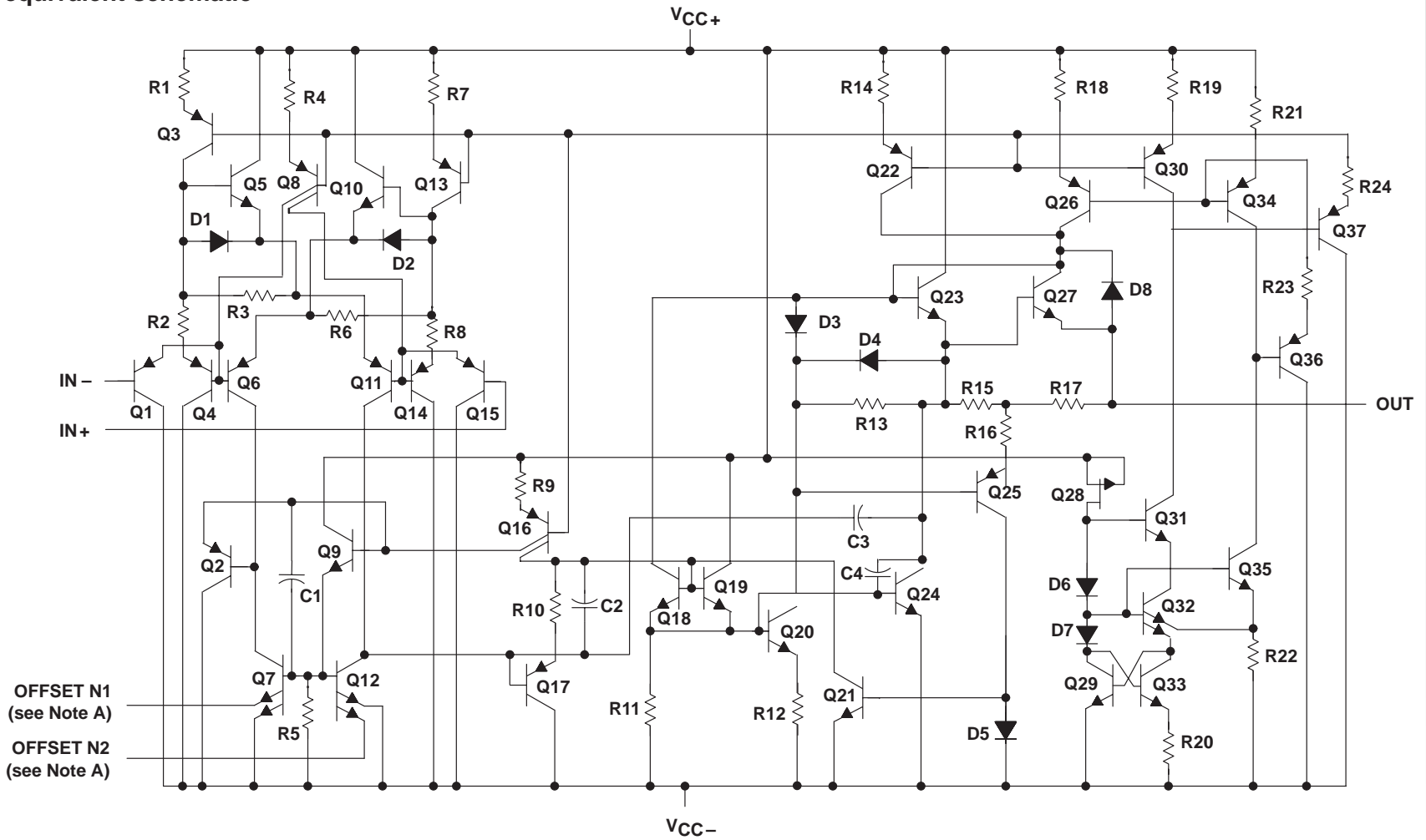

NOTE A: OFFSET N1 AND OFFSET N2 are only available on the TLE2241x devices.

ACTUAL DEVICE COMPONENT COUNT			
COMPONENT	TLE2241	TLE2242	TLE2244
Transistors	46	65	130
Resistors	24	43	86
Diodes	8	14	28
Capacitors	4	8	16
Epi-FET	1	1	2

TLE214x, TLE214xA, TLE214xY EXCALIBUR LOW-NOISE HIGH-SPEED PRECISION OPERATIONAL AMPLIFIERS

SLOS183A – FEBRUARY 1997 – REVISED MARCH 1998

absolute maximum ratings over operating free-air temperature range (unless otherwise noted)†

Supply voltage, V_{CC+} (see Note 1)	22 V
Supply voltage, V_{CC-}	-22 V
Differential input voltage, V_{ID} (see Note 2)	± 44 V
Input voltage range, V_I (any input)	V_{CC+} to $V_{CC-} - 0.3$ V
Input current, I_I (each input)	± 1 mA
Output current, I_O	± 80 mA
Total current into V_{CC+}	80 mA
Total current out of V_{CC-}	80 mA
Duration of short-circuit current at (or below) 25°C (see Note 3)	unlimited
Continuous total dissipation	See Dissipation Rating Table
Operating free-air temperature range, T_A : C suffix	0°C to 70°C
I suffix	-40°C to 105°C
M suffix	-55°C to 125°C
Storage temperature range	-65°C to 150°C
Case temperature for 60 seconds: FK package	260°C
Lead temperature 1,6 mm (1/16 inch) from case for 10 seconds: D, DW, N, P, or PW package	260°C
Lead temperature 1,6 mm (1/16 inch) from case for 60 seconds: J or JG package	300°C

† Stresses beyond those listed under “absolute maximum ratings” may cause permanent damage to the device. These are stress ratings only, and functional operation of the device at these or any other conditions beyond those indicated under “recommended operating conditions” is not implied. Exposure to absolute-maximum-rated conditions for extended periods may affect device reliability.

- NOTES: 1. All voltage values, except differential voltages, are with respect to the midpoint between V_{CC+} and V_{CC-} .
 2. Differential voltages are at $IN+$ with respect to $IN-$. Excessive current flows if input is brought below $V_{CC-} - 0.3$ V.
 3. The output may be shorted to either supply. Temperature and/or supply voltages must be limited to ensure that the maximum dissipation rating is not exceeded.

DISSIPATION RATING TABLE

PACKAGE	$T_A \leq 25^\circ\text{C}$ POWER RATING	DERATING FACTOR ABOVE $T_A = 25^\circ\text{C}$	$T_A = 70^\circ\text{C}$ POWER RATING	$T_A = 105^\circ\text{C}$ POWER RATING	$T_A = 125^\circ\text{C}$ POWER RATING
D	725 mW	5.8 mW/°C	464 mW	261 mW	145 mW
DW	1025 mW	8.2 mW/°C	656 mW	369 mW	205 mW
FK	1375 mW	11.0 mW/°C	880 mW	495 mW	275 mW
J	1375 mW	11.0 mW/°C	880 mW	495 mW	275 mW
JG	1050 mW	8.4 mW/°C	672 mW	378 mW	210 mW
N	1150 mW	9.2 mW/°C	736 mW	414 mW	230 mW
P	1000 mW	8.0 mW/°C	640 mW	360 mW	200 mW
PW	525 mW	4.2 mW/°C	336 mW	—	—

recommended operating conditions

	C SUFFIX		I SUFFIX		M SUFFIX		UNIT
	MIN	MAX	MIN	MAX	MIN	MAX	
Supply voltage, $V_{CC\pm}$	± 2	± 22	± 2	± 22	± 2	± 22	V
Common-mode input voltage, V_{IC}	$V_{CC} = 5$ V		0	2.9	0	2.7	V
	$V_{CC\pm} = \pm 15$ V		-15	12.9	-15	12.7	
Operating free-air temperature, T_A	0	70	-40	105	-55	125	°C



TLE214x, TLE214xA, TLE214xY
EXCALIBUR LOW-NOISE HIGH-SPEED
PRECISION OPERATIONAL AMPLIFIERS

SLOS183A – FEBRUARY 1997 – REVISED MARCH 1998

TLE2141C electrical characteristics at specified free-air temperature, $V_{CC} = 5\text{ V}$ (unless otherwise noted)

PARAMETER	TEST CONDITIONS	T_A †	TLE2141C			TLE2141AC			UNIT
			MIN	TYP	MAX	MIN	TYP	MAX	
V_{IO} Input offset voltage	$V_O = 2.5\text{ V}$ $V_{IC} = 2.5\text{ V}$ $R_S = 50\ \Omega$	25°C	225	1400		200	1000	μV	
		Full range			1700		1300		
α_{VIO} Temperature coefficient of input offset voltage		Full range	1.7			1.7		$\mu\text{V}/^\circ\text{C}$	
I_{IO} Input offset current		25°C	8	100		8	100	nA	
		Full range			150		150		
I_{IB} Input bias current		25°C	-0.8	-2		-0.8	-2	μA	
	Full range			-2.1		-2.1			
V_{ICR} Common-mode input voltage range	$R_S = 50\ \Omega$	25°C	0 to 3	-0.3 to 3.2		0 to 3	-0.3 to 3.2	V	
		Full range	0 to 2.9			0 to 2.9			
V_{OH} High-level output voltage	$I_{OH} = -150\ \mu\text{A}$	25°C	3.9	4.1		3.9	4.1	V	
		Full range	3.8			3.8			
	$I_{OH} = -1.5\text{ mA}$	25°C	3.8	4		3.8	4		
		Full range	3.7			3.7			
	$I_{OH} = -15\text{ mA}$	25°C	3.2	3.7		3.2	3.7		
		Full range	3.2			3.2			
V_{OL} Low-level output voltage	$I_{OL} = 150\ \mu\text{A}$	25°C		75	125		75	125	mV
		Full range			150		150		
	$I_{OL} = 1.5\text{ mA}$	25°C		150	225		150	225	
		Full range			250		250		
	$I_{OL} = 15\text{ mA}$	25°C		1.2	1.6		1.2	1.6	V
		Full range			1.7		1.7		
A_{VD} Large-signal differential voltage amplification	$V_{CC} = \pm 2.5\text{ V}$, $R_L = 2\text{ k}\Omega$, $V_O = 1\text{ V to } -1.5\text{ V}$	25°C	50	220		50	220	V/mV	
		Full range	25			25			
r_i Input resistance		25°C		70		70	M Ω		
c_i Input capacitance		25°C		2.5		2.5	pF		
z_o Open-loop output impedance	$f = 1\text{ MHz}$	25°C		30		30	Ω		
CMRR Common-mode rejection ratio	$V_{IC} = V_{ICRmin}$, $R_S = 50\ \Omega$	25°C	85	118		85	118	dB	
		Full range	80			80			
k_{SVR} Supply-voltage rejection ratio ($\Delta V_{CC\pm} / \Delta V_{IO}$)	$V_{CC\pm} = \pm 2.5\text{ V to } \pm 15\text{ V}$, $R_S = 50\ \Omega$	25°C	90	106		90	106	dB	
		Full range	85			85			
I_{CC} Supply current	$V_O = 2.5\text{ V}$, No load, $V_{IC} = 2.5\text{ V}$	25°C	3.4	4.4		3.4	4.4	mA	
		Full range			4.6		4.6		

† Full range is 0°C to 70°C.

TLE214x, TLE214xA, TLE214xY
EXCALIBUR LOW-NOISE HIGH-SPEED
PRECISION OPERATIONAL AMPLIFIERS

SLOS183A – FEBRUARY 1997 – REVISED MARCH 1998

TLE2141C operating characteristics, $V_{CC} = 5\text{ V}$, $T_A = 25^\circ\text{C}$

PARAMETER	TEST CONDITIONS	TLE2141C			TLE2141AC			UNIT
		MIN	TYP	MAX	MIN	TYP	MAX	
SR+	Positive slew rate	$A_{VD} = -1$, $R_L = 2\text{ k}\Omega^\dagger$, $C_L = 500\text{ pF}^\dagger$			45			V/ μs
SR-	Negative slew rate				42			
t_s	Settling time	$A_{VD} = -1$, 2.5-V step	To 0.1%	0.16			μs	
			To 0.01%	0.22				
V_n	Equivalent input noise voltage	$R_S = 20\ \Omega$, $f = 10\text{ Hz}$	15			nV/ $\sqrt{\text{Hz}}$		
		$R_S = 20\ \Omega$, $f = 1\text{ kHz}$	10.5					
$V_{N(PP)}$	Peak-to-peak equivalent input noise voltage	$f = 0.1\text{ Hz to }1\text{ Hz}$	0.48			μV		
		$f = 0.1\text{ Hz to }10\text{ Hz}$	0.51					
I_n	Equivalent input noise current	$f = 10\text{ Hz}$	1.92			pA/ $\sqrt{\text{Hz}}$		
		$f = 1\text{ kHz}$	0.5					
THD + N	Total harmonic distortion plus noise	$V_O = 1\text{ V to }3\text{ V}$, $R_L = 2\text{ k}\Omega^\dagger$, $A_{VD} = 2$, $f = 10\text{ kHz}$	0.0052%					
B_1	Unity-gain bandwidth	$R_L = 2\text{ k}\Omega^\dagger$, $C_L = 100\text{ pF}^\dagger$	5.9			MHz		
	Gain-bandwidth product	$R_L = 2\text{ k}\Omega^\dagger$, $C_L = 100\text{ pF}^\dagger$, $f = 100\text{ kHz}$	5.8			MHz		
B_{OM}	Maximum output-swing bandwidth	$V_{O(PP)} = 2\text{ V}$, $R_L = 2\text{ k}\Omega^\dagger$, $A_{VD} = 1$, $C_L = 100\text{ pF}^\dagger$	660			kHz		
ϕ_m	Phase margin at unity gain	$R_L = 2\text{ k}\Omega^\dagger$, $C_L = 100\text{ pF}^\dagger$	57°					

$^\dagger R_L$ and C_L terminated to 2.5 V.



TLE214x, TLE214xA, TLE214xY
EXCALIBUR LOW-NOISE HIGH-SPEED
PRECISION OPERATIONAL AMPLIFIERS

SLOS183A – FEBRUARY 1997 – REVISED MARCH 1998

TLE2141C electrical characteristics at specified free-air temperature, $V_{CC\pm} = \pm 15\text{ V}$ (unless otherwise noted)

PARAMETER	TEST CONDITIONS	T_A †	TLE2141C			TLE2141AC			UNIT
			MIN	TYP	MAX	MIN	TYP	MAX	
V_{IO} Input offset voltage	$V_{IC} = 0,$ $V_O = 0$ $R_S = 50\ \Omega$	25°C	200	900		175	500	μV	
		Full range			1300		800		
α_{VIO} Temperature coefficient of input offset voltage		Full range	1.7			1.7		$\mu\text{V}/^\circ\text{C}$	
I_{IO} Input offset current		25°C	7	100		7	100	nA	
		Full range			150		150		
I_{IB} Input bias current		25°C	-0.7	-1.5		-0.7	-1.5	μA	
	Full range			-1.6		-1.6			
V_{ICR} Common-mode input voltage range	$R_S = 50\ \Omega$	25°C	-15 to 13	-15.3 to 13.2		-15 to 13	-15.3 to 13.2	V	
		Full range	-15 to 12.9	-15.3 to 13.1		-15 to 12.9	-15.3 to 13.1		
V_{OM+} Maximum positive peak output voltage swing	$I_O = -150\ \mu\text{A}$	25°C	13.8	14.1		13.8	14.1	V	
		Full range	13.7			13.7			
	$I_O = -1.5\ \text{mA}$	25°C	13.7	14		13.7	14		
		Full range	13.6			13.6			
$I_O = -15\ \text{mA}$	25°C	13.1	13.7		13.1	13.7			
	Full range	13			13				
V_{OM-} Maximum negative peak output voltage swing	$I_O = 150\ \mu\text{A}$	25°C	-14.7	-14.9		-14.7	-14.9	V	
		Full range	-14.6			-14.6			
	$I_O = 1.5\ \text{mA}$	25°C	-14.5	-14.8		-14.5	-14.8		
		Full range	-14.4			-14.4			
$I_O = 15\ \text{mA}$	25°C	-13.4	-13.8		-13.4	-13.8			
	Full range	-13.3			-13.3				
A_{VD} Large-signal differential voltage amplification	$V_O = \pm 10\ \text{V}$	25°C	100	450		100	450	V/mV	
		Full range	75			75			
r_i Input resistance	$R_L = 2\ \text{k}\Omega$	25°C		65		65	M Ω		
c_i Input capacitance		25°C		2.5		2.5	pF		
z_o Open-loop output impedance	$f = 1\ \text{MHz}$	25°C		30		30	Ω		
CMRR Common-mode rejection ratio	$V_{IC} = V_{ICRmin}, R_S = 50\ \Omega$	25°C	85	108		85	108	dB	
		Full range	80			80			
k_{SVR} Supply-voltage rejection ratio ($\Delta V_{CC\pm}/\Delta V_{IO}$)	$V_{CC\pm} = \pm 2.5\ \text{V to } \pm 15\ \text{V},$ $R_S = 50\ \Omega$	25°C	90	106		90	106	dB	
		Full range	85			85			
I_{OS} Short-circuit output current	$V_O = 0$	25°C	$V_{ID} = 1\ \text{V}$	-25	-50		-25	-50	mA
			$V_{ID} = -1\ \text{V}$	20	31		20	31	
I_{CC} Supply current	$V_O = 0,$ No load	25°C		3.5	4.5		3.5	4.5	mA
		Full range			4.7		4.7		

† Full range is 0°C to 70°C.



TLE214x, TLE214xA, TLE214xY
EXCALIBUR LOW-NOISE HIGH-SPEED
PRECISION OPERATIONAL AMPLIFIERS

SLOS183A – FEBRUARY 1997 – REVISED MARCH 1998

TLE2141C operating characteristics, $V_{CC\pm} = \pm 15\text{ V}$, $T_A = 25^\circ\text{C}$

PARAMETER	TEST CONDITIONS	TLE2141C			TLE2141AC			UNIT	
		MIN	TYP	MAX	MIN	TYP	MAX		
SR+	Positive slew rate	$A_{VD} = -1$, $C_L = 500\text{ pF}$		$R_L = 2\text{ k}\Omega$	27	45	27	45	V/ μs
SR-	Negative slew rate				27	42	27	42	
t_s	Settling time	$A_{VD} = -1$, 10-V step	To 0.1%	0.34			μs		
			To 0.01%	0.4					
V_n	Equivalent input noise voltage	$R_S = 20\ \Omega$, $f = 10\text{ Hz}$	15			nV/ $\sqrt{\text{Hz}}$			
		$R_S = 20\ \Omega$, $f = 1\text{ kHz}$	10.5						
$V_{N(PP)}$	Peak-to-peak equivalent input noise voltage	$f = 0.1\text{ Hz to }1\text{ Hz}$	0.48			μV			
		$f = 0.1\text{ Hz to }10\text{ Hz}$	0.51						
I_n	Equivalent input noise current	$f = 10\text{ Hz}$	1.89			pA/ $\sqrt{\text{Hz}}$			
		$f = 1\text{ kHz}$	0.47						
THD + N	Total harmonic distortion plus noise	$V_{O(PP)} = 20\text{ V}$, $A_{VD} = 10$, $R_L = 2\text{ k}\Omega$, $f = 10\text{ kHz}$	0.01%			0.01%			
B_1	Unity-gain bandwidth	$R_L = 2\text{ k}\Omega$, $C_L = 100\text{ pF}$	6			MHz			
	Gain-bandwidth product	$R_L = 2\text{ k}\Omega$, $f = 100\text{ kHz}$	5.9			MHz			
B_{OM}	Maximum output-swing bandwidth	$V_{O(PP)} = 20\text{ V}$, $A_{VD} = 1$, $R_L = 2\text{ k}\Omega$, $C_L = 100\text{ pF}$	668			kHz			
ϕ_m	Phase margin at unity gain	$R_L = 2\text{ k}\Omega$, $C_L = 100\text{ pF}$	58°			58°			



TLE214x, TLE214xA, TLE214xY
EXCALIBUR LOW-NOISE HIGH-SPEED
PRECISION OPERATIONAL AMPLIFIERS

SLOS183A – FEBRUARY 1997 – REVISED MARCH 1998

TLE2142C electrical characteristics at specified free-air temperature, $V_{CC} = 5\text{ V}$ (unless otherwise noted)

PARAMETER	TEST CONDITIONS	T_A †	TLE2142C			TLE2142AC			UNIT
			MIN	TYP	MAX	MIN	TYP	MAX	
V_{IO} Input offset voltage	$V_O = 2.5\text{ V}, R_S = 50\ \Omega, V_{IC} = 2.5\text{ V}$	25°C	220	1900		200	1500	μV	
		Full range			2200		1800		
α_{VIO} Temperature coefficient of input offset voltage		Full range	1.7			1.7		$\mu\text{V}/^\circ\text{C}$	
I_{IO} Input offset current		25°C	8	100		8	100	nA	
		Full range			150		150		
I_{IB} Input bias current		25°C	-0.8	-2		-0.8	-2	μA	
	Full range			-2.1		-2.1			
V_{ICR} Common-mode input voltage range	$R_S = 50\ \Omega$	25°C	0 to 3	-0.3 to 3.2		0 to 3	-0.3 to 3.2	V	
		Full range	0 to 2.9			0 to 2.9			
V_{OH} High-level output voltage	$I_{OH} = -150\ \mu\text{A}$	25°C	3.9	4.1		3.9	4.1	V	
		Full range	3.8			3.8			
		25°C	3.8	4		3.8	4		
		Full range	3.7			3.7			
V_{OH} High-level output voltage	$I_{OH} = -1.5\text{ mA}$	25°C	3.4	3.7		3.4	3.7	V	
		Full range	3.4			3.4			
		25°C	3.4	3.7		3.4	3.7		
		Full range	3.4			3.4			
V_{OL} Low-level output voltage	$I_{OL} = 150\ \mu\text{A}$	25°C		75	125		75	125	mV
		Full range			150			150	
	$I_{OL} = 1.5\text{ mA}$	25°C		150	225		150	225	mV
		Full range			250			250	
	$I_{OL} = 15\text{ mA}$	25°C		1.2	1.4		1.2	1.4	V
		Full range			1.5			1.5	
A_{VD} Large-signal differential voltage amplification	$V_{CC} = \pm 2.5\text{ V}, R_L = 2\text{ k}\Omega, V_O = 1\text{ V to } -1.5\text{ V}$	25°C	50	220		50	220	V/mV	
		Full range	25			25			
r_i Input resistance		25°C		70		70	$\text{M}\Omega$		
c_i Input capacitance		25°C		2.5		2.5	pF		
z_o Open-loop output impedance	$f = 1\text{ MHz}$	25°C		30		30	Ω		
CMRR Common-mode rejection ratio	$V_{IC} = V_{ICRmin}, R_S = 50\ \Omega$	25°C	85	118		85	118	dB	
		Full range	80			80			
k_{SVR} Supply-voltage rejection ratio ($\Delta V_{CC\pm} / \Delta V_{IO}$)	$V_{CC\pm} = \pm 2.5\text{ V to } \pm 15\text{ V}, R_S = 50\ \Omega$	25°C	90	106		90	106	dB	
		Full range	85			85			
I_{CC} Supply current	$V_O = 2.5\text{ V}, V_{IC} = 2.5\text{ V}, \text{ No load,}$	25°C	6.6	8.8		6.6	8.8	mA	
		Full range			9.2		9.2		

† Full range is 0°C to 70°C.



TLE214x, TLE214xA, TLE214xY
EXCALIBUR LOW-NOISE HIGH-SPEED
PRECISION OPERATIONAL AMPLIFIERS

SLOS183A – FEBRUARY 1997 – REVISED MARCH 1998

TLE2142C operating characteristics, $V_{CC} = 5\text{ V}$, $T_A = 25^\circ\text{C}$

PARAMETER	TEST CONDITIONS	TLE2142C			TLE2142AC			UNIT
		MIN	TYP	MAX	MIN	TYP	MAX	
SR+	Positive slew rate	$A_{VD} = -1$, $C_L = 500\text{ pF}$		$R_L = 2\text{ k}\Omega^\dagger$		45		V/ μs
SR-	Negative slew rate					42		
t_s	Settling time	$A_{VD} = -1$, 2.5-V step	To 0.1%		0.16		μs	
			To 0.01%		0.22			
V_n	Equivalent input noise voltage	$R_S = 20\ \Omega$, $f = 10\text{ Hz}$		15		15		nV/ $\sqrt{\text{Hz}}$
		$R_S = 20\ \Omega$, $f = 1\text{ kHz}$		10.5		10.5		
$V_{N(PP)}$	Peak-to-peak equivalent input noise voltage	$f = 0.1\text{ Hz to }1\text{ Hz}$		0.48		0.48		μV
		$f = 0.1\text{ Hz to }10\text{ Hz}$		0.51		0.51		
I_n	Equivalent input noise current	$f = 10\text{ Hz}$		1.92		1.92		pA/ $\sqrt{\text{Hz}}$
		$f = 1\text{ kHz}$		0.5		0.5		
THD + N	Total harmonic distortion plus noise	$V_O = 1\text{ V to }3\text{ V}$, $A_{VD} = 2$, $R_L = 2\text{ k}\Omega^\dagger$, $f = 10\text{ kHz}$		0.0052%		0.0052%		
B1	Unity-gain bandwidth	$R_L = 2\text{ k}\Omega^\dagger$, $C_L = 100\text{ pF}$		5.9		5.9		MHz
	Gain-bandwidth product	$R_L = 2\text{ k}\Omega^\dagger$, $f = 100\text{ kHz}$		5.8		5.8		MHz
BOM	Maximum output-swing bandwidth	$V_{O(PP)} = 2\text{ V}$, $A_{VD} = 1$, $R_L = 2\text{ k}\Omega^\dagger$, $C_L = 100\text{ pF}$		660		660		kHz
ϕ_m	Phase margin at unity gain	$R_L = 2\text{ k}\Omega^\dagger$, $C_L = 100\text{ pF}$		57°		57°		

$^\dagger R_L$ terminates at 2.5 V.



TLE214x, TLE214xA, TLE214xY
EXCALIBUR LOW-NOISE HIGH-SPEED
PRECISION OPERATIONAL AMPLIFIERS

SLOS183A – FEBRUARY 1997 – REVISED MARCH 1998

TLE2142C electrical characteristics at specified free-air temperature, $V_{CC\pm} = \pm 15$ V (unless otherwise noted)

PARAMETER	TEST CONDITIONS	T _A †	TLE2142C			TLE2142AC			UNIT
			MIN	TYP	MAX	MIN	TYP	MAX	
V _{IO} Input offset voltage	V _{IC} = 0, V _O = 0 R _S = 50 Ω	25°C	290	1200		275	750	μV	
		Full range			1600		1200		
α _{VIO} Temperature coefficient of input offset voltage		Full range	1.7			1.7		μV/°C	
I _{IO} Input offset current		25°C	7	100		7	100	nA	
		Full range			150		150		
I _{IB} Input bias current		25°C	-0.7	-1.5		-0.7	-1.5	μA	
	Full range			-1.6		-1.6			
V _{ICR} Common-mode input voltage range	R _S = 50 Ω	25°C	-15 to 13	-15.3 to 13.2		-15 to 13	-15.3 to 13.2	V	
		Full range	-15 to 12.9	-15.3 to 13.1		-15 to 12.9	-15.3 to 13.1		
V _{OM+} Maximum positive peak output voltage swing	I _O = -150 μA	25°C	13.8	14.1		13.8	14.1	V	
		Full range	13.7			13.7			
	I _O = -1.5 mA	25°C	13.7	14		13.7	14		
		Full range	13.6			13.6			
	I _O = -15 mA	25°C	13.3	13.7		13.3	13.7		
		Full range	13.2			13.2			
V _{OM-} Maximum negative peak output voltage swing	I _O = 150 μA	25°C	-14.7	-14.9		-14.7	-14.9	V	
		Full range	-14.6			-14.6			
	I _O = 1.5 mA	25°C	-14.5	-14.8		-14.5	-14.8		
		Full range	-14.4			-14.4			
	I _O = 15 mA	25°C	-13.4	-13.8		-13.4	-13.8		
		Full range	-13.3			-13.3			
A _{VD} Large-signal differential voltage amplification	V _O = ±10 V	25°C	100	450		100	450	V/mV	
		Full range	75			75			
r _i Input resistance	R _L = 2 kΩ	25°C		65		65	MΩ		
c _i Input capacitance		25°C		2.5		2.5	pF		
z _o Open-loop output impedance	f = 1 MHz	25°C		30		30	Ω		
CMRR Common-mode rejection ratio	V _{IC} = V _{ICRmin} , R _S = 50 Ω	25°C	85	108		85	108	dB	
		Full range	80			80			
k _{SVR} Supply-voltage rejection ratio (ΔV _{CC±} /ΔV _{IO})	V _{CC±} = ± 2.5 V to ± 15 V, R _S = 50 Ω	25°C	90	106		90	106	dB	
		Full range	85			85			
I _{OS} Short-circuit output current	V _O = 0	25°C	V _{ID} = 1 V	-25	-50		-25	-50	mA
			V _{ID} = -1 V	20	31		20	31	
I _{CC} Supply current	V _O = 0, No load	25°C		6.9	9		6.9	9	mA
		Full range			9.4			9.4	

† Full range is 0°C to 70°C.



TLE214x, TLE214xA, TLE214xY
EXCALIBUR LOW-NOISE HIGH-SPEED
PRECISION OPERATIONAL AMPLIFIERS

SLOS183A – FEBRUARY 1997 – REVISED MARCH 1998

TLE2142C operating characteristics, $V_{CC\pm} = \pm 15\text{ V}$, $T_A = 25^\circ\text{C}$

PARAMETER	TEST CONDITIONS	TLE2142C			TLE2142AC			UNIT	
		MIN	TYP	MAX	MIN	TYP	MAX		
SR+	Positive slew rate	$A_{VD} = -1$, $C_L = 500\text{ pF}$		$R_L = 2\text{ k}\Omega$	27	45	27	45	V/ μ s
SR-	Negative slew rate				27	42	27	42	
t_s	Settling time	$A_{VD} = -1$, 10-V step	To 0.1%		0.34		0.34		μ s
			To 0.01%		0.4		0.4		
V_n	Equivalent input noise voltage	$R_S = 20\ \Omega$, $f = 10\text{ Hz}$	15		15		nV/ $\sqrt{\text{Hz}}$		
		$R_S = 20\ \Omega$, $f = 1\text{ kHz}$	10.5		10.5				
$V_{N(PP)}$	Peak-to-peak equivalent input noise voltage	f = 0.1 Hz to 1 Hz		0.48		0.48		μ V	
		f = 0.1 Hz to 10 Hz		0.51		0.51			
I_n	Equivalent input noise current	f = 10 Hz		1.89		1.89		pA/ $\sqrt{\text{Hz}}$	
		f = 1 kHz		0.47		0.47			
THD + N	Total harmonic distortion plus noise	$V_{O(PP)} = 20\text{ V}$, $A_{VD} = 10$,	$R_L = 2\text{ k}\Omega$, f = 10 kHz	0.01%		0.01%			
B_1	Unity-gain bandwidth	$R_L = 2\text{ k}\Omega$,	$C_L = 100\text{ pF}$	6		6		MHz	
	Gain-bandwidth product	$R_L = 2\text{ k}\Omega$, f = 100 kHz	$C_L = 100\text{ pF}$	5.9		5.9		MHz	
B_{OM}	Maximum output-swing bandwidth	$V_{O(PP)} = 20\text{ V}$, $A_{VD} = 1$,	$R_L = 2\text{ k}\Omega$, $C_L = 100\text{ pF}$	668		668		kHz	
ϕ_m	Phase margin at unity gain	$R_L = 2\text{ k}\Omega$,	$C_L = 100\text{ pF}$	58°		58°			



TLE214x, TLE214xA, TLE214xY
EXCALIBUR LOW-NOISE HIGH-SPEED
PRECISION OPERATIONAL AMPLIFIERS

SLOS183A – FEBRUARY 1997 – REVISED MARCH 1998

TLE2144C electrical characteristics at specified free-air temperature, $V_{CC} = 5\text{ V}$ (unless otherwise noted)

PARAMETER	TEST CONDITIONS	T_A †	TLE2144C			TLE2144AC			UNIT
			MIN	TYP	MAX	MIN	TYP	MAX	
V_{IO} Input offset voltage	$V_O = 2.5\text{ V}$, $V_{IC} = 2.5\text{ V}$ $R_S = 50\ \Omega$	25°C		0.5	3.8		0.5	3	mV
		Full range			4.4			3.6	
α_{VIO} Temperature coefficient of input offset voltage		Full range		1.7			1.7		$\mu\text{V}/^\circ\text{C}$
I_{IO} Input offset current		25°C		8	100		8	100	nA
		Full range			150			150	
I_{IB} Input bias current		25°C		-0.8	-2		-0.8	-2	μA
	Full range			-2.1			-2.1		
V_{ICR} Common-mode input voltage range	$R_S = 50\ \Omega$	25°C	0 to 3	-0.3 to 3.2		0 to 3	-0.3 to 3.2	V	
		Full range	0 to 2.9			0 to 2.9			
V_{OH} High-level output voltage	$I_{OH} = -150\ \mu\text{A}$	25°C	3.9	4.1		3.9	4.1	V	
		Full range	3.8			3.8			
	$I_{OH} = -1.5\text{ mA}$	25°C	3.8	4		3.8	4		
		Full range	3.7			3.7			
	$I_{OH} = -15\text{ mA}$	25°C	3.4	3.7		3.4	3.7		
		Full range	3.4			3.4			
V_{OL} Low-level output voltage	$I_{OL} = 150\ \mu\text{A}$	25°C		75	125		75	125	mV
		Full range			150			150	
	$I_{OL} = 1.5\text{ mA}$	25°C		150	225		150	225	
		Full range			250			250	
	$I_{OL} = 15\text{ mA}$	25°C		1.2	1.6		1.2	1.6	V
		Full range			1.7			1.7	
A_{VD} Large-signal differential voltage amplification	$V_{CC} = \pm 2.5\text{ V}$, $V_O = 1\text{ V to } -1.5\text{ V}$, $R_L = 2\text{ k}\Omega$	25°C	50	95		50	95	V/mV	
		Full range	25			25			
r_i Input resistance		25°C		70		70	$\text{M}\Omega$		
c_i Input capacitance		25°C		2.5		2.5	pF		
z_o Open-loop output impedance	$f = 1\text{ MHz}$	25°C		30		30	Ω		
CMRR Common-mode rejection ratio	$V_{IC} = V_{ICRmin}$, $R_S = 50\ \Omega$	25°C	85	118		85	118	dB	
		Full range	80			80			
k_{SVR} Supply-voltage rejection ratio ($\Delta V_{CC\pm}/\Delta V_{IO}$)	$V_{CC\pm} = \pm 2.5\text{ V to } \pm 15\text{ V}$, $R_S = 50\ \Omega$	25°C	90	106		90	106	dB	
		Full range	85			85			
I_{CC} Supply current	$V_O = 2.5\text{ V}$, $V_{IC} = 2.5\text{ V}$ No load,	25°C		13.2	17.6		13.2	17.6	mA
		Full range			18.5			18.5	

† Full range is 0°C to 70°C.



TLE214x, TLE214xA, TLE214xY EXCALIBUR LOW-NOISE HIGH-SPEED PRECISION OPERATIONAL AMPLIFIERS

SLOS183A – FEBRUARY 1997 – REVISED MARCH 1998

TLE2144C operating characteristics, $V_{CC} = 5\text{ V}$, $T_A = 25^\circ\text{C}$

PARAMETER	TEST CONDITIONS	TLE2144C			TLE2144AC			UNIT	
		MIN	TYP	MAX	MIN	TYP	MAX		
SR+	Positive slew rate	$A_{VD} = -1$, $C_L = 500\text{ pF}$		$R_L = 2\text{ k}\Omega^\dagger$		45			$\text{V}/\mu\text{s}$
SR-	Negative slew rate					42			
t_s	Settling time	$A_{VD} = -1$, 2.5-V step	To 0.1%		0.16			μs	
			To 0.01%		0.22				
V_n	Equivalent input noise voltage	$R_S = 20\ \Omega$, $f = 10\text{ Hz}$		15			$\text{nV}/\sqrt{\text{Hz}}$		
		$R_S = 20\ \Omega$, $f = 1\text{ kHz}$		10.5					
$V_{N(PP)}$	Peak-to-peak equivalent input noise voltage	$f = 0.1\text{ Hz to }1\text{ Hz}$		0.48			μV		
		$f = 0.1\text{ Hz to }10\text{ Hz}$		0.51					
I_n	Equivalent input noise current	$f = 10\text{ Hz}$		1.92			$\text{pA}/\sqrt{\text{Hz}}$		
		$f = 1\text{ kHz}$		0.5					
THD + N	Total harmonic distortion plus noise	$V_O = 1\text{ V to }3\text{ V}$, $A_{VD} = 2$, $R_L = 2\text{ k}\Omega^\dagger$, $f = 10\text{ kHz}$		0.0052%					
B_1	Unity-gain bandwidth	$R_L = 2\text{ k}\Omega^\dagger$, $C_L = 100\text{ pF}$		5.9			MHz		
	Gain-bandwidth product	$R_L = 2\text{ k}\Omega^\dagger$, $f = 100\text{ kHz}$		5.8			MHz		
BOM	Maximum output-swing bandwidth	$V_{O(PP)} = 2\text{ V}$, $A_{VD} = 1$, $R_L = 2\text{ k}\Omega^\dagger$, $C_L = 100\text{ pF}$		660			kHz		
ϕ_m	Phase margin at unity gain	$R_L = 2\text{ k}\Omega^\dagger$, $C_L = 100\text{ pF}$		57°					

$^\dagger R_L$ terminates at 2.5 V

TLE214x, TLE214xA, TLE214xY
EXCALIBUR LOW-NOISE HIGH-SPEED
PRECISION OPERATIONAL AMPLIFIERS

SLOS183A – FEBRUARY 1997 – REVISED MARCH 1998

TLE2144C electrical characteristics at specified free-air temperature, $V_{CC\pm} = \pm 15\text{ V}$ (unless otherwise noted)

PARAMETER	TEST CONDITIONS	T_A †	TLE2144C			TLE2144AC			UNIT
			MIN	TYP	MAX	MIN	TYP	MAX	
V_{IO} Input offset voltage	$V_{IC} = 0,$ $V_O = 0$ $R_S = 50\ \Omega$	25°C	0.6 2.4		0.5 1.5		mV		
		Full range	3.2		2.4				
α_{VIO} Temperature coefficient of input offset voltage		Full range	1.7		1.7		$\mu\text{V}/^\circ\text{C}$		
I_{IO} Input offset current		25°C	7	100	7	100	nA		
		Full range	150		150				
I_{IB} Input bias current		25°C	-0.7	-1.5	-0.7	-1.5	μA		
	Full range	-1.6		-1.6					
V_{ICR} Common-mode input voltage range	$R_S = 50\ \Omega$	25°C	-15 to 13	-15.3 to 13.2	-15 to 13	-15.3 to 13.2	V		
		Full range	-15 to 12.9	-15.3 to 13.1	-15 to 12.9	-15 to 13.1			
V_{OM+} Maximum positive peak output voltage swing	$I_O = -150\ \mu\text{A}$	25°C	13.8	14.1	13.8	14.1	V		
		Full range	13.7		13.7				
	$I_O = -1.5\ \text{mA}$	25°C	13.7	14	13.7	14			
		Full range	13.6		13.6				
	$I_O = -15\ \text{mA}$	25°C	13.1	13.7	13.1	13.7			
		Full range	13		13				
V_{OM-} Maximum negative peak output voltage swing	$I_O = 150\ \mu\text{A}$	25°C	-14.7	-14.9	-14.7	-14.9	V		
		Full range	-14.6		-14.6				
	$I_O = 1.5\ \text{mA}$	25°C	-14.5	-14.8	-14.5	-14.8			
		Full range	-14.4		-14.4				
	$I_O = 15\ \text{mA}$	25°C	-13.4	-13.8	-13.4	-13.8			
		Full range	-13.3		-13.3				
A_{VD} Large-signal differential voltage amplification	$V_O = \pm 10\ \text{V}$	25°C	100	170	100	170	V/mV		
		Full range	75		75				
r_i Input resistance	$R_L = 2\ \text{k}\Omega$	25°C	65		65		M Ω		
c_i Input capacitance		25°C	2.5		2.5		pF		
z_o Open-loop output impedance	$f = 1\ \text{MHz}$	25°C	30		30		Ω		
CMRR Common-mode rejection ratio	$V_{IC} = V_{ICRmin}, R_S = 50\ \Omega$	25°C	85	108	85	108	dB		
		Full range	80		80				
k_{SVR} Supply-voltage rejection ratio ($\Delta V_{CC\pm}/\Delta V_{IO}$)	$V_{CC\pm} = \pm 2.5\ \text{V to } \pm 15\ \text{V},$ $R_S = 50\ \Omega$	25°C	90	106	90	106	dB		
		Full range	85		85				
I_{OS} Short-circuit output current	$V_O = 0$	25°C	$V_{ID} = 1\ \text{V}$	-25	-50	-25	-50	mA	
			$V_{ID} = -1\ \text{V}$	20	31	20	31		
I_{CC} Supply current	$V_O = 0,$ No load	25°C	13.8	18	13.8	18	mA		
		Full range	18.8		18.8				

† Full range is 0°C to 70°C.



TLE214x, TLE214xA, TLE214xY
EXCALIBUR LOW-NOISE HIGH-SPEED
PRECISION OPERATIONAL AMPLIFIERS

SLOS183A – FEBRUARY 1997 – REVISED MARCH 1998

TLE2144C operating characteristics, $V_{CC\pm} = \pm 15\text{ V}$, $T_A = 25^\circ\text{C}$

PARAMETER	TEST CONDITIONS	TLE2144C			TLE2144AC			UNIT	
		MIN	TYP	MAX	MIN	TYP	MAX		
SR+	Positive slew rate	$A_{VD} = -1$, $C_L = 500\text{ pF}$		$R_L = 2\text{ k}\Omega$	27	45	27	45	V/ μs
SR-	Negative slew rate				27	42	27	42	
t_s	Settling time	$A_{VD} = -1$, 10-V step	To 0.1%	0.34		0.34		μs	
			To 0.01%	0.4		0.4			
V_n	Equivalent input noise voltage	$R_S = 20\ \Omega$, $f = 10\text{ Hz}$	15		15		nV/ $\sqrt{\text{Hz}}$		
		$R_S = 20\ \Omega$, $f = 1\text{ kHz}$	10.5		10.5				
$V_{N(PP)}$	Peak-to-peak equivalent input noise voltage	$f = 0.1\text{ Hz to }1\text{ Hz}$		0.48		0.48		μV	
		$f = 0.1\text{ Hz to }10\text{ Hz}$		0.51		0.51			
I_n	Equivalent input noise current	$f = 10\text{ Hz}$		1.89		1.89		pA/ $\sqrt{\text{Hz}}$	
		$f = 1\text{ kHz}$		0.47		0.47			
THD + N	Total harmonic distortion plus noise	$V_{O(PP)} = 20\text{ V}$, $A_{VD} = 10$,	$R_L = 2\text{ k}\Omega$, $f = 10\text{ kHz}$	0.01%		0.01%			
B_1	Unity-gain bandwidth	$R_L = 2\text{ k}\Omega$,	$C_L = 100\text{ pF}$	6		6		MHz	
	Gain-bandwidth product	$R_L = 2\text{ k}\Omega$, $f = 100\text{ kHz}$	$C_L = 100\text{ pF}$,	5.9		5.9		MHz	
B_{OM}	Maximum output-swing bandwidth	$V_{O(PP)} = 20\text{ V}$, $A_{VD} = 1$,	$R_L = 2\text{ k}\Omega$, $C_L = 100\text{ pF}$	668		668		kHz	
ϕ_m	Phase margin at unity gain	$R_L = 2\text{ k}\Omega$,	$C_L = 100\text{ pF}$	58°		58°			



TLE214x, TLE214xA, TLE214xY
EXCALIBUR LOW-NOISE HIGH-SPEED
PRECISION OPERATIONAL AMPLIFIERS

SLOS183A – FEBRUARY 1997 – REVISED MARCH 1998

TLE2141I electrical characteristics at specified free-air temperature, $V_{CC} = 5\text{ V}$ (unless otherwise noted)

PARAMETER	TEST CONDITIONS	T_A †	TLE2141I			TLE2141AI			UNIT
			MIN	TYP	MAX	MIN	TYP	MAX	
V_{IO} Input offset voltage	$V_O = 2.5\text{ V}$, $V_{IC} = 2.5\text{ V}$ $R_S = 50\ \Omega$	25°C	225	1400		200	1000	μV	
		Full range			1900		1500		
α_{VIO} Temperature coefficient of input offset voltage		Full range	1.7			1.7		$\mu\text{V}/^\circ\text{C}$	
I_{IO} Input offset current		25°C	8	100		8	100	nA	
		Full range			200		200		
I_{IB} Input bias current		25°C	-0.8	-2		-0.8	-2	μA	
	Full range			-2.2		-2.2			
V_{ICR} Common-mode input voltage range	$R_S = 50\ \Omega$	25°C	0 to 3	-0.3 to 3.2		0 to 3	-0.3 to 3.2	V	
		Full range	0 to 2.7	-0.3 to 2.9		0 to 2.7	-0.3 to 2.9		
V_{OH} High-level output voltage	$I_{OH} = -150\ \mu\text{A}$ $I_{OH} = -1.5\text{ mA}$ $I_{OH} = -15\text{ mA}$ $I_{OH} = -100\ \mu\text{A}$ $I_{OH} = -1\text{ mA}$ $I_{OH} = -10\text{ mA}$	25°C	3.9	4.1		3.9	4.1	V	
			3.8	4		3.8	4		
			3.2	3.7		3.2	3.7		
		Full range	3.8			3.8			
			3.7			3.7			
			3.3			3.3			
V_{OL} Low-level output voltage	$I_{OL} = 150\ \mu\text{A}$ $I_{OL} = 1.5\ \mu\text{A}$ $I_{OL} = 15\text{ mA}$ $I_{OL} = 100\ \mu\text{A}$ $I_{OL} = 1\text{ mA}$ $I_{OL} = 10\text{ mA}$	25°C	75	125		75	125	mV	
			150	225		150	225		
			1.2	1.6		1.2	1.6		
		Full range	175			175			
			225			225			
			1.4			1.4			
A_{VD} Large-signal differential voltage amplification	$V_{CC} = \pm 2.5\text{ V}$, $R_L = 2\text{ k}\Omega$, $V_O = 1\text{ V to } -1.5\text{ V}$	25°C	50	220		50	220	V/mV	
		Full range	10			10			
r_i Input resistance		25°C	70			70	M Ω		
c_i Input capacitance		25°C	2.5			2.5	pF		
z_o Open-loop output impedance	$f = 1\text{ MHz}$	25°C	30			30	Ω		
CMRR Common-mode rejection ratio	$V_{IC} = V_{ICRmin}$, $R_S = 50\ \Omega$	25°C	85	118		85	118	dB	
		Full range	80			80			
k_{SVR} Supply-voltage rejection ratio ($\Delta V_{CC\pm} / \Delta V_{IO}$)	$V_{CC\pm} = \pm 2.5\text{ V to } \pm 15\text{ V}$, $R_S = 50\ \Omega$	25°C	90	106		90	106	dB	
		Full range	85			85			
I_{CC} Supply current	$V_O = 2.5\text{ V}$, $V_{IC} = 2.5\text{ V}$ No load,	25°C	3.4	4.4		3.4	4.4	mA	
		Full range			4.6		4.6		

† Full range is -40°C to 105°C.



TLE214x, TLE214xA, TLE214xY
EXCALIBUR LOW-NOISE HIGH-SPEED
PRECISION OPERATIONAL AMPLIFIERS

SLOS183A – FEBRUARY 1997 – REVISED MARCH 1998

TLE2141I operating characteristics, $V_{CC} = 5\text{ V}$, $T_A = 25^\circ\text{C}$

PARAMETER	TEST CONDITIONS	TLE2141I			TLE2141AI			UNIT
		MIN	TYP	MAX	MIN	TYP	MAX	
SR+	Positive slew rate	$A_{VD} = -1$, $R_L = 2\text{ k}\Omega^\dagger$, $C_L = 500\text{ pF}$			45			V/ μs
SR-	Negative slew rate				42			
t_s	Settling time	$A_{VD} = -1$, 2.5-V step	To 0.1%	0.16			μs	
			To 0.01%	0.22				
V_n	Equivalent input noise voltage	$R_S = 20\ \Omega$, $f = 10\text{ Hz}$	15			nV/ $\sqrt{\text{Hz}}$		
		$R_S = 20\ \Omega$, $f = 1\text{ kHz}$	10.5					
$V_{N(PP)}$	Peak-to-peak equivalent input noise voltage	$f = 0.1\text{ Hz to }1\text{ Hz}$	0.48			μV		
		$f = 0.1\text{ Hz to }10\text{ Hz}$	0.51					
I_n	Equivalent input noise current	$f = 10\text{ Hz}$	1.92			pA/ $\sqrt{\text{Hz}}$		
		$f = 1\text{ kHz}$	0.5					
THD + N	Total harmonic distortion plus noise	$V_O = 1\text{ V to }3\text{ V}$, $R_L = 2\text{ k}\Omega^\dagger$, $A_{VD} = 2$, $f = 10\text{ kHz}$	0.0052%					
B_1	Unity-gain bandwidth	$R_L = 2\text{ k}\Omega^\dagger$, $C_L = 100\text{ pF}^\dagger$	5.9			MHz		
	Gain-bandwidth product	$R_L = 2\text{ k}\Omega^\dagger$, $C_L = 100\text{ pF}^\dagger$, $f = 100\text{ kHz}$	5.8			MHz		
B_{OM}	Maximum output-swing bandwidth	$V_{O(PP)} = 2\text{ V}$, $R_L = 2\text{ k}\Omega^\dagger$, $A_{VD} = 1$, $C_L = 100\text{ pF}^\dagger$	660			kHz		
ϕ_m	Phase margin at unity gain	$R_L = 2\text{ k}\Omega^\dagger$, $C_L = 100\text{ pF}^\dagger$	57°					

$^\dagger R_L$ and C_L terminated to 2.5 V.



TLE214x, TLE214xA, TLE214xY
EXCALIBUR LOW-NOISE HIGH-SPEED
PRECISION OPERATIONAL AMPLIFIERS

SLOS183A – FEBRUARY 1997 – REVISED MARCH 1998

TLE2141I electrical characteristics at specified free-air temperature, $V_{CC\pm} = \pm 15$ V (unless otherwise noted)

PARAMETER	TEST CONDITIONS	T_A †	TLE2141I			TLE2141AI			UNIT
			MIN	TYP	MAX	MIN	TYP	MAX	
V_{IO} Input offset voltage	$V_{IC} = 0,$ $V_O = 0$ $R_S = 50 \Omega$	25°C	200	900		175	500	μV	
		Full range			1500		1000		
αV_{IO} Temperature coefficient of input offset voltage		Full range	1.7			1.7		$\mu V/^\circ C$	
I_{IO} Input offset current		25°C	7	100		7	100	nA	
		Full range			200		200		
I_{IB} Input bias current		25°C	-0.7	-1.5		-0.7	-1.5	μA	
	Full range			-1.7		-1.7			
V_{ICR} Common-mode input voltage range	$R_S = 50 \Omega$	25°C	-15 to 13	-15.3 to 13.2		-15 to 13	-15.3 to 13.2	V	
		Full range	-15 to 12.7	-15.3 to 12.9		-15 to 12.7	-15.3 to 12.9		
V_{OM+} Maximum positive peak output voltage swing	$I_O = -150 \mu A$	25°C	13.8	14.1		13.8	14.1	V	
	$I_O = -1.5$ mA		13.7	14		13.7	14		
	$I_O = -15$ mA		13.1	13.7		13.1	13.7		
	$I_O = -100 \mu A$	Full range	13.7			13.7			
	$I_O = -1$ mA		13.6			13.6			
	$I_O = -10$ mA		13.1			13.1			
V_{OM-} Maximum negative peak output voltage swing	$I_O = 150 \mu A$	25°C	-14.7	-14.9		-14.7	-14.9	V	
	$I_O = 1.5$ mA		-14.5	-14.8		-14.5	-14.8		
	$I_O = 15$ mA		-13.4	-13.8		-13.4	-13.8		
	$I_O = 100 \mu A$	Full range	-14.6			-14.6			
	$I_O = 1$ mA		-14.5			-14.5			
	$I_O = 10$ mA		-13.4			-13.4			
A_{VD} Large-signal differential voltage amplification	$V_O = \pm 10$ V, $R_L = 2$ k Ω	25°C	100	450		100	450	V/mV	
		Full range	40			40			
r_i Input resistance		25°C	65			65	M Ω		
c_i Input capacitance		25°C	2.5			2.5	pF		
z_o Open-loop output impedance	$f = 1$ MHz	25°C	30			30	Ω		
CMRR Common-mode rejection ratio	$V_{IC} = V_{ICRmin}, R_S = 50 \Omega$	25°C	85	108		85	108	dB	
		Full range	80			80			
k_{SVR} Supply-voltage rejection ratio ($\Delta V_{CC\pm} / \Delta V_{IO}$)	$V_{CC\pm} = \pm 2.5$ V to ± 15 V, $R_S = 50 \Omega$	25°C	90	106		90	106	dB	
		Full range	85			85			
I_{OS} Short-circuit output current	$V_O = 0$	25°C	$V_{ID} = 1$ V	-25	-50		-25	-50	mA
			$V_{ID} = -1$ V	20	31		20	31	
I_{CC} Supply current	$V_O = 0,$ No load	25°C	3.5	4.5		3.5	4.5	mA	
		Full range			4.7		4.7		

† Full range is $-40^\circ C$ to $105^\circ C$.



TLE214x, TLE214xA, TLE214xY
EXCALIBUR LOW-NOISE HIGH-SPEED
PRECISION OPERATIONAL AMPLIFIERS

SLOS183A – FEBRUARY 1997 – REVISED MARCH 1998

TLE2141I operating characteristics, $V_{CC\pm} = \pm 15\text{ V}$, $T_A = 25^\circ\text{C}$

PARAMETER	TEST CONDITIONS	TLE2141I			TLE2141AI			UNIT	
		MIN	TYP	MAX	MIN	TYP	MAX		
SR+	Positive slew rate	$A_{VD} = -1$, $C_L = 500\text{ pF}$		$R_L = 2\text{ k}\Omega$	27	45	27	45	V/ μs
SR-	Negative slew rate				27	42	27	42	
t_s	Settling time	$A_{VD} = -1$, 10-V step			To 0.1%	0.34		μs	
					To 0.01%	0.4			
V_n	Equivalent input noise voltage	$R_S = 20\ \Omega$, $f = 10\text{ Hz}$			15	15		nV/ $\sqrt{\text{Hz}}$	
		$R_S = 20\ \Omega$, $f = 1\text{ kHz}$			10.5	10.5			
$V_{N(PP)}$	Peak-to-peak equivalent input noise voltage	$f = 0.1\text{ Hz to }1\text{ Hz}$			0.48	0.48		μV	
		$f = 0.1\text{ Hz to }10\text{ Hz}$			0.51	0.51			
I_n	Equivalent input noise current	$f = 10\text{ Hz}$			1.89	1.89		pA/ $\sqrt{\text{Hz}}$	
		$f = 1\text{ kHz}$			0.47	0.47			
THD + N	Total harmonic distortion plus noise	$V_{O(PP)} = 20\text{ V}$, $A_{VD} = 10$,		$R_L = 2\text{ k}\Omega$, $f = 10\text{ kHz}$	0.01%		0.01%		
B_1	Unity-gain bandwidth	$R_L = 2\text{ k}\Omega$,	$C_L = 100\text{ pF}$		6		6		MHz
	Gain-bandwidth product	$R_L = 2\text{ k}\Omega$, $f = 100\text{ kHz}$	$C_L = 100\text{ pF}$		5.9		5.9		MHz
B_{OM}	Maximum output-swing bandwidth	$V_{O(PP)} = 20\text{ V}$, $A_{VD} = 1$,		$R_L = 2\text{ k}\Omega$, $C_L = 100\text{ pF}$	668		668		kHz
ϕ_m	Phase margin at unity gain	$R_L = 2\text{ k}\Omega$,		$C_L = 100\text{ pF}$		58°		58°	



TLE214x, TLE214xA, TLE214xY
EXCALIBUR LOW-NOISE HIGH-SPEED
PRECISION OPERATIONAL AMPLIFIERS

SLOS183A – FEBRUARY 1997 – REVISED MARCH 1998

TLE2142I electrical characteristics at specified free-air temperature, $V_{CC} = 5\text{ V}$ (unless otherwise noted)

PARAMETER	TEST CONDITIONS	T_A †	TLE2142I			TLE2142AI			UNIT
			MIN	TYP	MAX	MIN	TYP	MAX	
V_{IO} Input offset voltage	$V_O = 2.5\text{ V}$, $V_{IC} = 2.5\text{ V}$ $R_S = 50\ \Omega$	25°C	220	1900		220	1500	μV	
		Full range			2400		2000		
α_{VIO} Temperature coefficient of input offset voltage		Full range	1.7			1.7		$\mu\text{V}/^\circ\text{C}$	
I_{IO} Input offset current		25°C	8	100		8	100	nA	
		Full range			200		200		
I_{IB} Input bias current		25°C	-0.8	-2		-0.8	-2	μA	
	Full range			-2.2		-2.2			
V_{ICR} Common-mode input voltage range	$R_S = 50\ \Omega$	25°C	0 to 3	-0.3 to 3.2		0 to 3	-0.3 to 3.2	V	
		Full range	0 to 2.7	-0.3 to 2.9		0 to 2.7	-0.3 to 2.9		
V_{OH} High-level output voltage	$I_{OH} = -150\ \mu\text{A}$ $I_{OH} = -1.5\text{ mA}$ $I_{OH} = -15\text{ mA}$ $I_{OH} = 100\ \mu\text{A}$ $I_{OH} = 1\text{ mA}$ $I_{OH} = 10\text{ mA}$	25°C	3.9	4.1		3.9	4.1	V	
			3.8	4		3.8	4		
			3.4	3.7		3.4	3.7		
		Full range	3.8			3.8			
			3.7			3.7			
			3.5			3.5			
V_{OL} Low-level output voltage	$I_{OL} = 150\ \mu\text{A}$ $I_{OL} = 1.5\text{ mA}$ $I_{OL} = 15\text{ mA}$ $I_{OL} = 100\ \mu\text{A}$ $I_{OL} = 1\text{ mA}$ $I_{OL} = 10\text{ mA}$	25°C	75	125		75	125	mV	
			150	225		150	225		
			1.2	1.4		1.2	1.4		
		Full range	175			175			
			225			225			
			1.2			1.2			
A_{VD} Large-signal differential voltage amplification	$V_{IC} = \pm 2.5\text{ V}$, $V_O = 1\text{ V to } -1.5\text{ V}$, $R_L = 2\text{ k}\Omega$	25°C	50	220		50	220	V/mV	
		Full range	10			10			
r_i Input resistance		25°C	70			70	M Ω		
c_i Input capacitance		25°C	2.5			2.5	pF		
z_o Open-loop output impedance	$f = 1\text{ MHz}$	25°C	30			30	Ω		
CMRR Common-mode rejection ratio	$V_{IC} = V_{ICRmin}$, $R_S = 50\ \Omega$	25°C	85	118		85	118	dB	
		Full range	80			80			
k_{SVR} Supply-voltage rejection ratio ($\Delta V_{CC\pm} / \Delta V_{IO}$)	$V_{CC\pm} = \pm 2.5\text{ V to } \pm 15\text{ V}$, $R_S = 50\ \Omega$	25°C	90	106		90	106	dB	
		Full range	85			85			
I_{CC} Supply current	$V_O = 2.5\text{ V}$, $V_{IC} = 2.5\text{ V}$	No load,	25°C	6.6	8.8		6.6	8.8	mA
			Full range			9.2		9.2	

† Full range is -40°C to 105°C.

TLE214x, TLE214xA, TLE214xY
EXCALIBUR LOW-NOISE HIGH-SPEED
PRECISION OPERATIONAL AMPLIFIERS

SLOS183A – FEBRUARY 1997 – REVISED MARCH 1998

TLE2142I operating characteristics, $V_{CC} = 5\text{ V}$, $T_A = 25^\circ\text{C}$

PARAMETER	TEST CONDITIONS	TLE2142I			TLE2142AI			UNIT
		MIN	TYP	MAX	MIN	TYP	MAX	
SR+	Positive slew rate	$A_{VD} = -1$, $R_L = 2\text{ k}\Omega^\dagger$, $C_L = 500\text{ pF}$		45	45		V/ μs	
SR-	Negative slew rate			42	42			
t_s	Settling time	$A_{VD} = -1$, 2.5-V step	To 0.1%	0.16	0.16		μs	
			To 0.01%	0.22	0.22			
V_n	Equivalent input noise voltage	$R_S = 20\ \Omega$, $f = 10\text{ Hz}$	15	15		nV/ $\sqrt{\text{Hz}}$		
		$R_S = 20\ \Omega$, $f = 1\text{ kHz}$	10.5	10.5				
$V_{N(PP)}$	Peak-to-peak equivalent input noise voltage	$f = 0.1\text{ Hz to }1\text{ Hz}$	0.48	0.48		μV		
		$f = 0.1\text{ Hz to }10\text{ Hz}$	0.51	0.51				
I_n	Equivalent input noise current	$f = 10\text{ Hz}$	1.92	1.92		pA/ $\sqrt{\text{Hz}}$		
		$f = 1\text{ kHz}$	0.5	0.5				
THD + N	Total harmonic distortion plus noise	$V_O = 1\text{ V to }3\text{ V}$, $R_L = 2\text{ k}\Omega^\dagger$, $A_{VD} = 2$, $f = 10\text{ kHz}$	0.0052%	0.0052%				
B_1	Unity-gain bandwidth	$R_L = 2\text{ k}\Omega^\dagger$, $C_L = 100\text{ pF}$	5.9	5.9		MHz		
	Gain-bandwidth product	$R_L = 2\text{ k}\Omega^\dagger$, $C_L = 100\text{ pF}$, $f = 100\text{ kHz}$	5.8	5.8		MHz		
BOM	Maximum output-swing bandwidth	$V_{O(PP)} = 2\text{ V}$, $R_L = 2\text{ k}\Omega^\dagger$, $A_{VD} = 1$, $C_L = 100\text{ pF}$	660	660		kHz		
ϕ_m	Phase margin at unity gain	$R_L = 2\text{ k}\Omega^\dagger$, $C_L = 100\text{ pF}$	57°	57°				

$^\dagger R_L$ terminates at 2.5 V.



TLE214x, TLE214xA, TLE214xY
EXCALIBUR LOW-NOISE HIGH-SPEED
PRECISION OPERATIONAL AMPLIFIERS

SLOS183A – FEBRUARY 1997 – REVISED MARCH 1998

TLE2142I electrical characteristics at specified free-air temperature, $V_{CC\pm} = \pm 15$ V (unless otherwise noted)

PARAMETER	TEST CONDITIONS	T _A †	TLE2142I			TLE2142I			UNIT
			MIN	TYP	MAX	MIN	TYP	MAX	
V _{IO} Input offset voltage	V _{IC} = 0, R _S = 50 Ω, V _O = 0	25°C	290	1200		275	750	μV	
		Full range			1800		1400		
α _{VIO} Temperature coefficient of input offset voltage		Full range	1.7			1.7		μV/°C	
I _{IO} Input offset current		25°C	7	100		7	100	nA	
		Full range			200		200		
I _{IB} Input bias current		25°C	-0.7	-1.5		-0.7	-1.5	μA	
	Full range			-1.7		-1.7			
V _{ICR} Common-mode input voltage range	R _S = 50 Ω	25°C	-15 to 13	-15.3 to 13.2		-15 to 13	-15.3 to 13.2	V	
		Full range	-15 to 12.7	-15.3 to 12.9		-15 to 12.7	-15.3 to 12.9		
V _{OM+} Maximum positive peak output voltage swing	I _O = -150 μA	25°C	13.8	14.1		13.8	14.1	V	
	I _O = -1.5 mA		13.7	14		13.7	14		
	I _O = -15 mA		13.3	13.7		13.3	13.7		
	Full range	I _O = -100 μA	13.7			13.7			
		I _O = -1 mA	13.6			13.6			
		I _O = -10 mA	13.3			13.3			
V _{OM-} Maximum negative peak output voltage swing	I _O = 150 μA	25°C	-14.7	-14.9		-14.7	-14.9	V	
	I _O = 1.5 mA		-14.5	-14.8		-14.5	-14.8		
	I _O = 15 mA		-13.4	-13.8		-13.4	-13.8		
	Full range	I _O = 100 μA	-14.6			-14.6			
		I _O = 1 mA	-14.5			-14.5			
		I _O = 10 mA	-13.4			-13.4			
A _{VD} Large-signal differential voltage amplification	V _O = ±10 V, R _L = 2 kΩ	25°C	100	450		100	450	V/mV	
		Full range	40			40			
r _i Input resistance		25°C	65			65	MΩ		
c _i Input capacitance		25°C	2.5			2.5	pF		
z _o Open-loop output impedance	f = 1 MHz	25°C	30			30	Ω		
CMRR Common-mode rejection ratio	V _{IC} = V _{ICRmin}	25°C	85	108		85	108	dB	
	R _S = 50 Ω	Full range	80			80			
k _{SVR} Supply-voltage rejection ratio (ΔV _{CC±} / ΔV _{IO})	V _{CC±} = ±2.5 V to ±15 V, R _S = 50 Ω	25°C	90	106		90	106	dB	
		Full range	85			85			
I _{OS} Short-circuit output current	V _O = 0	25°C	V _{ID} = 1 V	-25	-50		-25	-50	mA
			V _{ID} = -1 V	20	31		20	31	
I _{CC} Supply current	V _O = 0, No load	25°C	6.9	9		6.9	9	mA	
		Full range			9.4		9.4		

† Full range is -40°C to 105°C.



TLE214x, TLE214xA, TLE214xY
EXCALIBUR LOW-NOISE HIGH-SPEED
PRECISION OPERATIONAL AMPLIFIERS

SLOS183A – FEBRUARY 1997 – REVISED MARCH 1998

TLE2142I operating characteristics, $V_{CC\pm} = \pm 15\text{ V}$, $T_A = 25^\circ\text{C}$

PARAMETER	TEST CONDITIONS	TLE2142I			TLE2142AI			UNIT
		MIN	TYP	MAX	MIN	TYP	MAX	
SR+	Positive slew rate	$A_{VD} = -1$, $R_L = 2\text{ k}\Omega$, $C_L = 500\text{ pF}$		30	45	30	45	V/ μs
SR-	Negative slew rate			30	42	30	42	
t_s	Settling time	$A_{VD} = -1$, 10-V step	To 0.1%	0.34			μs	
			To 0.01%	0.4				
V_n	Equivalent input noise voltage	$R_S = 20\ \Omega$, $f = 10\text{ Hz}$	15			$\text{nV}/\sqrt{\text{Hz}}$		
		$R_S = 20\ \Omega$, $f = 1\text{ kHz}$	10.5					
$V_{N(PP)}$	Peak-to-peak equivalent input noise voltage	$f = 0.1\text{ Hz to }1\text{ Hz}$	0.48			μV		
		$f = 0.1\text{ Hz to }10\text{ Hz}$	0.51					
I_n	Equivalent input noise current	$f = 10\text{ Hz}$	1.89			$\text{pA}/\sqrt{\text{Hz}}$		
		$f = 1\text{ kHz}$	0.47					
THD + N	Total harmonic distortion plus noise	$V_{O(PP)} = 20\text{ V}$, $A_{VD} = 10$,	$R_L = 2\text{ k}\Omega$, $f = 10\text{ kHz}$	0.01%				
B_1	Unity-gain bandwidth	$R_L = 2\text{ k}\Omega$,	$C_L = 100\text{ pF}$	6			MHz	
	Gain-bandwidth product	$R_L = 2\text{ k}\Omega$, $f = 100\text{ kHz}$		5.9			MHz	
B_{OM}	Maximum output-swing bandwidth	$V_{O(PP)} = 20\text{ V}$, $A_{VD} = 1$,	$R_L = 2\text{ k}\Omega$, $C_L = 100\text{ pF}$	668			kHz	
ϕ_m	Phase margin at unity gain	$R_L = 2\text{ k}\Omega$,	$C_L = 100\text{ pF}$	58°				



TLE214x, TLE214xA, TLE214xY
EXCALIBUR LOW-NOISE HIGH-SPEED
PRECISION OPERATIONAL AMPLIFIERS

SLOS183A – FEBRUARY 1997 – REVISED MARCH 1998

TLE2144I electrical characteristics at specified free-air temperature, $V_{CC} = 5\text{ V}$ (unless otherwise noted)

PARAMETER	TEST CONDITIONS	T_A †	TLE2144I			TLE2144AI			UNIT
			MIN	TYP	MAX	MIN	TYP	MAX	
V_{IO} Input offset voltage	$V_{IC} = 0,$ $V_O = 0$ $R_S = 50\ \Omega$	25°C	0.5	3.8		0.5	3	mV	
		Full range			4.8		4		
α_{VIO} Temperature coefficient of input offset voltage		Full range	1.7			1.7		$\mu\text{V}/^\circ\text{C}$	
I_{IO} Input offset current		25°C	8	100		8	100	nA	
		Full range			200		200		
I_{IB} Input bias current		25°C	-0.8	-2		-0.8	-2	μA	
	Full range			-2.2		-2.2			
V_{ICR} Common-mode input voltage range	$R_S = 50\ \Omega$	25°C	0 to 3	-0.3 to 3.2		0 to 3	-0.3 to 3.2	V	
		Full range	0 to 2.7	-0.3 to 2.9		0 to 2.7	-0.3 to 2.9		
V_{OH} High-level output voltage	$I_{OH} = -150\ \mu\text{A}$	25°C	3.9	4.1		3.9	4.1	V	
	$I_{OH} = -1.5\ \text{mA}$		3.8	4		3.8	4		
	$I_{OH} = -15\ \text{mA}$		3.4	3.7		3.4	3.7		
	$I_{OH} = 100\ \mu\text{A}$	Full range	3.8			3.8			
	$I_{OH} = 1\ \text{mA}$		3.7			3.7			
	$I_{OH} = 10\ \text{mA}$		3.5			3.5			
V_{OL} Low-level output voltage	$I_{OL} = 150\ \mu\text{A}$	25°C	75	125		75	125	mV	
	$I_{OL} = 1.5\ \mu\text{A}$		150	225		150	225		
	$I_{OL} = 15\ \text{mA}$		1.2	1.6		1.2	1.6	V	
	$I_{OL} = 100\ \mu\text{A}$	Full range	175			175		mV	
	$I_{OL} = 1\ \text{mA}$		225			225			
	$I_{OL} = 10\ \text{mA}$		1.4			1.4		V	
A_{VD} Large-signal differential voltage amplification	$V_{IC} = \pm 2.5\ \text{V},$ $V_O = 1\ \text{V to } -1.5\ \text{V}$ $R_L = 2\ \text{k}\Omega$	25°C	50	95		50	95	V/mV	
		Full range	10			10			
r_i Input resistance		25°C	70			70	$\text{M}\Omega$		
c_i Input capacitance		25°C	2.5			2.5	pF		
z_o Open-loop output impedance	$f = 1\ \text{MHz}$	25°C	30			30	Ω		
CMRR Common-mode rejection ratio	$V_{IC} = V_{ICR\text{min}},$ $R_S = 50\ \Omega$	25°C	85	118		85	118	dB	
		Full range	80			80			
k_{SVR} Supply-voltage rejection ratio ($\Delta V_{CC\pm}/\Delta V_{IO}$)	$V_{CC\pm} = \pm 2.5\ \text{V to } \pm 15\ \text{V},$ $R_S = 50\ \Omega$	25°C	90	106		90	106	dB	
		Full range	85			85			
I_{CC} Supply current	$V_O = 2.5\ \text{V},$ $V_{IC} = 2.5\ \text{V}$ No load,	25°C	13.2	17.6		13.2	17.6	mA	
		Full range			18.4		18.4		

† Full range is -40°C to 105°C .

TLE214x, TLE214xA, TLE214xY
EXCALIBUR LOW-NOISE HIGH-SPEED
PRECISION OPERATIONAL AMPLIFIERS

SLOS183A – FEBRUARY 1997 – REVISED MARCH 1998

TLE2144I operating characteristics, $V_{CC} = 5\text{ V}$, $T_A = 25^\circ\text{C}$

PARAMETER	TEST CONDITIONS	TLE2144I			TLE2144AI			UNIT	
		MIN	TYP	MAX	MIN	TYP	MAX		
SR+	Positive slew rate	$A_{VD} = -1$, $C_L = 500\text{ pF}$		$R_L = 2\text{ k}\Omega^\dagger$		45		V/ μs	
SR-	Negative slew rate					42			
t_s	Settling time	$A_{VD} = -1$, 2.5-V step	To 0.1%		0.16		μs		
			To 0.01%		0.22				
V_n	Equivalent input noise voltage	$R_S = 20\ \Omega$, $f = 10\text{ Hz}$	15		15		$\text{nV}/\sqrt{\text{Hz}}$		
		$R_S = 20\ \Omega$, $f = 1\text{ kHz}$	10.5		10.5				
$V_{N(PP)}$	Peak-to-peak equivalent input noise voltage	$f = 0.1\text{ Hz to }1\text{ Hz}$		0.48		0.48		μV	
		$f = 0.1\text{ Hz to }10\text{ Hz}$		0.51		0.51			
I_n	Equivalent input noise current	$f = 10\text{ Hz}$		1.92		1.92		$\text{pA}/\sqrt{\text{Hz}}$	
		$f = 10\text{ kHz}$		0.5		0.5			
THD + N	Total harmonic distortion plus noise	$V_O = 1\text{ V to }3\text{ V}$, $A_{VD} = 2$,	$R_L = 2\text{ k}\Omega^\dagger$, $f = 10\text{ kHz}$		0.0052%		0.0052%		
B_1	Unity-gain bandwidth	$R_L = 2\text{ k}\Omega^\dagger$,	$C_L = 100\text{ pF}$		5.9		5.9		MHz
	Gain-bandwidth product	$R_L = 2\text{ k}\Omega^\dagger$, $f = 100\text{ kHz}$	$C_L = 100\text{ pF}$		5.8		5.8		MHz
B_{OM}	Maximum output-swing bandwidth	$V_{O(PP)} = 2\text{ V}$, $A_{VD} = 1$,	$R_L = 2\text{ k}\Omega^\dagger$, $C_L = 100\text{ pF}$		660		660		kHz
ϕ_m	Phase margin at unity gain	$R_L = 2\text{ k}\Omega^\dagger$,	$C_L = 100\text{ pF}$		57°		57°		

$^\dagger R_L$ terminates at 2.5 V



TLE214x, TLE214xA, TLE214xY
EXCALIBUR LOW-NOISE HIGH-SPEED
PRECISION OPERATIONAL AMPLIFIERS

SLOS183A – FEBRUARY 1997 – REVISED MARCH 1998

TLE2144I electrical characteristics at specified free-air temperature, $V_{CC\pm} = \pm 15$ V (unless otherwise noted)

PARAMETER	TEST CONDITIONS	T _A †	TLE2144I			TLE2144AI			UNIT
			MIN	TYP	MAX	MIN	TYP	MAX	
V _{IO}	Input offset voltage	25°C	0.6	2.4		0.5	1.5	mV	
			Full range			2.8			
α _{VIO}	Temperature coefficient of input offset voltage	25°C	1.7			1.7			μV/°C
I _{IO}	Input offset current		7	100		7	100	nA	
I _{IB}	Input bias current	25°C	-0.7	-1.5		-0.7	-1.5	μA	
			Full range			-1.7			
V _{ICR}	Common-mode input voltage range	25°C	-15 to 13	-15.3 to 13.2		-15 to 13	-15.3 to 13.2	V	
			Full range			12.7 to 12.9			
V _{OM+}	Maximum positive peak output voltage swing	25°C	I _O = -150 μA	13.8	14.1	13.8	14.1	V	
			I _O = -1.5 mA	13.7	14	13.7	14		
			I _O = -15 mA	13.1	13.7	13.1	13.7		
		Full range	I _O = -100 μA	13.7		13.7			
			I _O = -1 mA	13.6		13.6			
			I _O = -10 mA	13.1		13.1			
V _{OM-}	Maximum negative peak output voltage swing	25°C	I _O = 150 μA	-14.7	-14.9	-14.7	-14.9	V	
			I _O = 1.5 mA	-14.5	-14.8	-14.5	-14.8		
			I _O = 15 mA	-13.4	-13.8	-13.4	-13.8		
		Full range	I _O = 100 μA	-14.6		-14.6			
			I _O = 1 mA	-14.5		-14.5			
			I _O = 10 mA	-13.4		-13.4			
A _{VD}	Large-signal differential voltage amplification	25°C	100	170		100	170	V/mV	
			Full range			40			
r _i	Input resistance	25°C	65			65			MΩ
c _i	Input capacitance	25°C	2.5			2.5			pF
z _o	Open-loop output impedance	25°C	30			30			Ω
CMRR	Common-mode rejection ratio	25°C	85	108		85	108	dB	
			Full range			80			
k _{SVR}	Supply-voltage rejection ratio (ΔV _{CC±} /ΔV _{IO})	25°C	90	106		90	106	dB	
			Full range			85			
I _{OS}	Short-circuit output current	25°C	-25	-50		-25	-50	mA	
			20	31		20	31		
I _{CC}	Supply current	25°C	13.8	18		13.8	18	mA	
			Full range			18.8			

† Full range is -40°C to 105°C.



TLE214x, TLE214xA, TLE214xY
EXCALIBUR LOW-NOISE HIGH-SPEED
PRECISION OPERATIONAL AMPLIFIERS

SLOS183A – FEBRUARY 1997 – REVISED MARCH 1998

TLE2144I operating characteristics, $V_{CC\pm} = \pm 15\text{ V}$, $T_A = 25^\circ\text{C}$

PARAMETER	TEST CONDITIONS	TLE2144I			TLE2144AI			UNIT	
		MIN	TYP	MAX	MIN	TYP	MAX		
SR+	Positive slew rate	$A_{VD} = -1$, $C_L = 500\text{ pF}$		$R_L = 2\text{ k}\Omega$	27	45	27	45	V/ μs
SR-	Negative slew rate				27	42	27	42	
t_s	Settling time	$A_{VD} = -1$, 10-V step	To 0.1%	0.34			μs		
			To 0.01%	0.4					
V_n	Equivalent input noise voltage	$R_S = 20\ \Omega$	$f = 10\text{ Hz}$	15			nV/ $\sqrt{\text{Hz}}$		
			$f = 1\text{ kHz}$	10.5					
$V_{N(PP)}$	Peak-to-peak equivalent input noise voltage	$f = 0.1\text{ Hz to }1\text{ Hz}$		0.48			μV		
		$f = 0.1\text{ Hz to }10\text{ Hz}$		0.51					
I_n	Equivalent input noise current	$f = 10\text{ Hz}$		1.89			pA/ $\sqrt{\text{Hz}}$		
		$f = 1\text{ kHz}$		0.47					
THD + N	Total harmonic distortion plus noise	$V_{O(PP)} = 20\text{ V}$, $A_{VD} = 10$,	$R_L = 2\text{ k}\Omega$, $f = 10\text{ kHz}$	0.01%					
B_1	Unity-gain bandwidth	$R_L = 2\text{ k}\Omega$,	$C_L = 100\text{ pF}$	6			MHz		
	Gain-bandwidth product	$R_L = 2\text{ k}\Omega$, $f = 100\text{ kHz}$		5.9			MHz		
B_{OM}	Maximum output-swing bandwidth	$V_{O(PP)} = 20\text{ V}$, $A_{VD} = 1$,	$R_L = 2\text{ k}\Omega$, $C_L = 100\text{ pF}$	668			kHz		
ϕ_m	Phase margin at unity gain	$R_L = 2\text{ k}\Omega$,	$C_L = 100\text{ pF}$	58°					



TLE214x, TLE214xA, TLE214xY
EXCALIBUR LOW-NOISE HIGH-SPEED
PRECISION OPERATIONAL AMPLIFIERS

SLOS183A – FEBRUARY 1997 – REVISED MARCH 1998

TLE2141M electrical characteristics at specified free-air temperature, $V_{CC} = 5\text{ V}$ (unless otherwise noted)

PARAMETER	TEST CONDITIONS	T_A †	TLE2141M			TLE2141AM			UNIT
			MIN	TYP	MAX	MIN	TYP	MAX	
V_{IO} Input offset voltage	$V_O = 2.5\text{ V}$ $V_{IC} = 2.5\text{ V}$ $R_S = 50\ \Omega$	25°C	225	1400		200	1000	μV	
		Full range			2100		1700		
α_{VIO} Temperature coefficient of input offset voltage		Full range	1.7			1.7		$\mu\text{V}/^\circ\text{C}$	
I_{IO} Input offset current		25°C	8	100		8	100	nA	
		Full range			250		250		
I_{IB} Input bias current		25°C	-0.8	-2		-0.8	-2	μA	
	Full range			-2.3		-2.3			
V_{ICR} Common-mode input voltage range	$R_S = 50\ \Omega$	25°C	0 to 3	-0.3 to 3.2		0 to 3	-0.3 to 3.2	V	
		Full range	0 to 2.7	-0.3 to 2.9		0 to 2.7	-0.3 to 2.9		
V_{OH} High-level output voltage	$I_{OH} = -150\ \mu\text{A}$ $I_{OH} = -1.5\text{ mA}$ $I_{OH} = -15\text{ mA}$ $I_{OH} = -100\ \mu\text{A}$ $I_{OH} = -1\text{ mA}$ $I_{OH} = -10\text{ mA}$	25°C	3.9	4.1		3.9	4.1	V	
			3.8	4		3.8	4		
		Full range	3.2	3.7		3.2	3.7		
			3.75			3.75			
			3.65			3.65			
			3.25			3.25			
V_{OL} Low-level output voltage	$I_{OL} = 150\ \mu\text{A}$ $I_{OL} = 1.5\ \mu\text{A}$ $I_{OL} = 15\text{ mA}$ $I_{OL} = 100\ \mu\text{A}$ $I_{OL} = 1\text{ mA}$ $I_{OL} = 10\text{ mA}$	25°C	75	125		75	125	mV	
			150	225		150	225		
		Full range	1.2	1.4		1.2	1.4		
			200			200			
			250			250			
			1.25			1.25			
A_{VD} Large-signal differential voltage amplification	$V_{IC} = \pm 2.5\text{ V}$, $R_L = 2\text{ k}\Omega$, $V_O = 1\text{ V to } -1.5\text{ V}$	25°C	50	220		50	220	V/mV	
		Full range	5			5			
r_i Input resistance		25°C	70		70		M Ω		
c_i Input capacitance		25°C	2.5		2.5		pF		
z_o Open-loop output impedance	$f = 1\text{ MHz}$	25°C	30		30		Ω		
CMRR Common-mode rejection ratio	$V_{IC} = V_{ICRmin}$, $R_S = 50\ \Omega$	25°C	85	118		85	118	dB	
		Full range	80			80			
k_{SVR} Supply-voltage rejection ratio ($\Delta V_{CC\pm} / \Delta V_{IO}$)	$V_{CC\pm} = \pm 2.5\text{ V to } \pm 15\text{ V}$, $R_S = 50\ \Omega$	25°C	90	106		90	106	dB	
		Full range	85			85			
I_{CC} Supply current	$V_O = 2.5\text{ V}$, $V_{IC} = 2.5\text{ V}$ No load,	25°C	3.4	4.4		3.4	4.4	mA	
		Full range			4.6		4.6		

† Full range is -55°C to 125°C .

TLE214x, TLE214xA, TLE214xY EXCALIBUR LOW-NOISE HIGH-SPEED PRECISION OPERATIONAL AMPLIFIERS

SLOS183A – FEBRUARY 1997 – REVISED MARCH 1998

TLE2141M operating characteristics, $V_{CC} = 5\text{ V}$, $T_A = 25^\circ\text{C}$

PARAMETER	TEST CONDITIONS	TLE2141M			TLE2141AM			UNIT			
		MIN	TYP	MAX	MIN	TYP	MAX				
SR+	Positive slew rate	$A_{VD} = -1$, $R_L = 2\text{ k}\Omega^\dagger$, $C_L = 500\text{ pF}$			45			V/ μs			
SR-	Negative slew rate				42						
t_s	Settling time	$A_{VD} = -1$, 2.5-V step	To 0.1%		0.16			μs			
			To 0.01%		0.22						
V_n	Equivalent input noise voltage	$R_S = 20\ \Omega$, $f = 10\text{ Hz}$	15			15			nV/ $\sqrt{\text{Hz}}$		
		$R_S = 20\ \Omega$, $f = 1\text{ kHz}$	10.5			10.5					
$V_{N(PP)}$	Peak-to-peak equivalent input noise voltage	$f = 0.1\text{ Hz to }1\text{ Hz}$		0.48			0.48			μV	
		$f = 0.1\text{ Hz to }10\text{ Hz}$		0.51			0.51				
I_n	Equivalent input noise current	$f = 10\text{ Hz}$		1.92			1.92			pA/ $\sqrt{\text{Hz}}$	
		$f = 1\text{ kHz}$		0.5			0.5				
THD + N	Total harmonic distortion plus noise	$V_O = 1\text{ V to }3\text{ V}$, $A_{VD} = 2$,	$R_L = 2\text{ k}\Omega^\dagger$, $f = 10\text{ kHz}$		0.0052%			0.0052%			
B_1	Unity-gain bandwidth	$R_L = 2\text{ k}\Omega^\dagger$, $C_L = 100\text{ pF}^\dagger$		5.9			5.9			MHz	
	Gain-bandwidth product	$R_L = 2\text{ k}\Omega^\dagger$, $f = 100\text{ kHz}$		5.8			5.8			MHz	
B_{OM}	Maximum output-swing bandwidth	$V_{O(PP)} = 2\text{ V}$, $A_{VD} = 1$	$R_L = 2\text{ k}\Omega^\dagger$		660			660			kHz
ϕ_m	Phase margin at unity gain	$R_L = 2\text{ k}\Omega^\dagger$, $C_L = 100\text{ pF}^\dagger$		57°			57°				

$^\dagger R_L$ and C_L terminated to 2.5 V.

TLE214x, TLE214xA, TLE214xY
EXCALIBUR LOW-NOISE HIGH-SPEED
PRECISION OPERATIONAL AMPLIFIERS

SLOS183A – FEBRUARY 1997 – REVISED MARCH 1998

TLE2141M electrical characteristics at specified free-air temperature, $V_{CC\pm} = \pm 15$ V (unless otherwise noted)

PARAMETER	TEST CONDITIONS	T_A †	TLE2141M			TLE2141AM			UNIT
			MIN	TYP	MAX	MIN	TYP	MAX	
V_{IO} Input offset voltage	$V_{IC} = 0, R_S = 50 \Omega$	25°C	200	900		175	500	μV	
		Full range			1700		1200		
α_{VIO} Temperature coefficient of input offset voltage		Full range		1.7			1.7	$\mu V/^\circ C$	
I_{IO} Input offset current		25°C		7	100		7	100	nA
		Full range			250			250	
I_{IB} Input bias current		25°C		-0.7	-1.5		-0.7	-1.5	μA
	Full range			-1.8			-1.8		
V_{ICR} Common-mode input voltage range	$R_S = 50 \Omega$	25°C	-15 to 13	-15.3 to 13.2		-15 to 13	-15.3 to 13.2	V	
		Full range	-15 to 12.7	-15.3 to 12.9		-15 to 12.7	-15.3 to 12.9		
V_{OM+} Maximum positive peak output voltage swing	$I_O = -150 \mu A$ $I_O = -1.5 mA$ $I_O = -15 mA$ $I_O = -100 \mu A$ $I_O = -1 mA$ $I_O = -10 mA$	25°C		13.8	14.1		13.8	14.1	V
				13.7	14		13.7	14	
				13.1	13.7		13.1	13.7	
		Full range		13.7			13.7		
				13.6			13.6		
				13.1			13.1		
V_{OM-} Maximum negative peak output voltage swing	$I_O = 150 \mu A$ $I_O = 1.5 mA$ $I_O = 15 mA$ $I_O = 100 \mu A$ $I_O = 1 mA$ $I_O = 10 mA$	25°C		-14.7	-14.9		-14.7	-14.9	V
				-14.5	-14.8		-14.5	-14.8	
				-13.4	-13.8		-13.4	-13.8	
		Full range		-14.6			-14.6		
				-14.5			-14.5		
				-13.4			-13.4		
A_{VD} Large-signal differential voltage amplification	$V_O = \pm 10 V, R_L = 2 k\Omega$	25°C	100	450		100	450	V/mV	
		Full range		20			20		
r_i Input resistance		25°C		65			65	M Ω	
c_i Input capacitance		25°C		2.5			2.5	pF	
z_o Open-loop output impedance	$f = 1 MHz$	25°C		30			30	Ω	
CMRR Common-mode rejection ratio	$V_{IC} = V_{ICRmin}, R_S = 50 \Omega$	25°C	85	108		85	108	dB	
		Full range		80			80		
k_{SVR} Supply-voltage rejection ratio ($\Delta V_{CC\pm} / \Delta V_{IO}$)	$V_{CC\pm} = \pm 2.5 V$ to $\pm 15 V, R_S = 50 \Omega$	25°C	90	106		90	106	dB	
		Full range		85			85		
I_{OS} Short-circuit output current	$V_O = 0$	25°C	$V_{ID} = 1 V$	-25	-50		-25	-50	mA
			$V_{ID} = -1 V$	20	31		20	31	
I_{CC} Supply current	$V_O = 0, V_{IC} = 2.5 V$	25°C		3.5	4.5		3.5	4.5	mA
		Full range			4.7			4.7	

† Full range is $-55^\circ C$ to $125^\circ C$.



TLE214x, TLE214xA, TLE214xY
EXCALIBUR LOW-NOISE HIGH-SPEED
PRECISION OPERATIONAL AMPLIFIERS

SLOS183A – FEBRUARY 1997 – REVISED MARCH 1998

TLE2141M operating characteristics, $V_{CC\pm} = \pm 15\text{ V}$, $T_A = 25^\circ\text{C}$

PARAMETER		TEST CONDITIONS		TLE2141M			TLE2141AM			UNIT
				MIN	TYP	MAX	MIN	TYP	MAX	
SR+	Positive slew rate	$A_{VD} = -1$, $C_L = 100\text{ pF}$	$R_L = 2\text{ k}\Omega$	27	45		27	45	V/ μs	
SR-	Negative slew rate			27	42		27	42		
t_s	Settling time	$A_{VD} = -1$, 10-V step	To 0.1%	0.34			0.34			μs
			To 0.01%	0.4			0.4			
V_n	Equivalent input noise voltage	$R_S = 20\ \Omega$	$f = 10\text{ Hz}$	15			15			nV/ $\sqrt{\text{Hz}}$
			$f = 1\text{ kHz}$	10.5			10.5			
$V_{N(PP)}$	Peak-to-peak equivalent input noise voltage	$f = 0.1\text{ Hz to }1\text{ Hz}$		0.48			0.48			μV
		$f = 0.1\text{ Hz to }10\text{ Hz}$		0.51			0.51			
I_n	Equivalent input noise current	$f = 10\text{ Hz}$		1.89			1.89			pA/ $\sqrt{\text{Hz}}$
		$f = 1\text{ kHz}$		0.47			0.47			
THD + N	Total harmonic distortion plus noise	$V_{O(PP)} = 20\text{ V}$, $A_{VD} = 10$,	$R_L = 2\text{ k}\Omega$, $f = 10\text{ kHz}$	0.01%			0.01%			
B_1	Unity-gain bandwidth	$R_L = 2\text{ k}\Omega$,	$C_L = 100\text{ pF}$	6			6			MHz
	Gain-bandwidth product	$R_L = 2\text{ k}\Omega$, $f = 100\text{ kHz}$	$C_L = 100\text{ pF}$	5.9			5.9			MHz
B_{OM}	Maximum output-swing bandwidth	$V_{O(PP)} = 20\text{ V}$, $A_{VD} = 1$,	$R_L = 2\text{ k}\Omega$, $C_L = 100\text{ pF}$	668			668			kHz
ϕ_m	Phase margin at unity gain	$R_L = 2\text{ k}\Omega$,	$C_L = 100\text{ pF}$	58°			58°			



TLE214x, TLE214xA, TLE214xY
EXCALIBUR LOW-NOISE HIGH-SPEED
PRECISION OPERATIONAL AMPLIFIERS

SLOS183A – FEBRUARY 1997 – REVISED MARCH 1998

TLE2142M electrical characteristics at specified free-air temperature, $V_{CC} = 5\text{ V}$ (unless otherwise noted)

PARAMETER	TEST CONDITIONS	T_A †	TLE2142M			TLE2142AM			UNIT
			MIN	TYP	MAX	MIN	TYP	MAX	
V_{IO} Input offset voltage	$V_O = 2.5\text{ V}$, $V_{IC} = 2.5\text{ V}$ $R_S = 50\ \Omega$	25°C	220	1900		200	1500	μV	
		Full range			2600		2200		
α_{VIO} Temperature coefficient of input offset voltage		Full range	1.7			1.7		$\mu\text{V}/^\circ\text{C}$	
I_{IO} Input offset current		25°C	8	100		8	100	nA	
		Full range			200		200		
I_{IB} Input bias current		25°C	-0.8	-2		-0.8	-2	μA	
	Full range			-2.3		-2.3			
V_{ICR} Common-mode input voltage range	$R_S = 50\ \Omega$	25°C	0 to 3	-0.3 to 3.2		0 to 3	-0.3 to 3.2	V	
		Full range	0 to 2.7	-0.3 to 2.9		0 to 2.7	-0.3 to 2.9		
V_{OH} High-level output voltage	$I_{OH} = -150\ \mu\text{A}$ $I_{OH} = -1.5\text{ mA}$ $I_{OH} = -15\text{ mA}$ $I_{OH} = 100\ \mu\text{A}$ $I_{OH} = 1\text{ mA}$ $I_{OH} = 10\text{ mA}$	25°C	3.9	4.1		3.9	4.1	V	
			3.8	4		3.8	4		
			3.4	3.7		3.4	3.7		
		Full range	3.75			3.75			
			3.65			3.65			
			3.45			3.45			
V_{OL} Low-level output voltage	$I_{OL} = 150\ \mu\text{A}$ $I_{OL} = 1.5\text{ mA}$ $I_{OL} = 15\text{ mA}$ $I_{OL} = 100\ \mu\text{A}$ $I_{OL} = 1\text{ mA}$ $I_{OL} = 10\text{ mA}$	25°C	75	125		75	125	mV	
			150	225		150	225		
			1.2	1.4		1.2	1.4		
		Full range	200			200			
			250			250			
			1.25			1.25			
A_{VD} Large-signal differential voltage amplification	$V_{IC} = \pm 2.5\text{ V}$, $V_O = 1\text{ V to } -1.5\text{ V}$, $R_L = 2\text{ k}\Omega$	25°C	50	220		50	220	V/mV	
		Full range	5			5			
r_i Input resistance		25°C	70			70	M Ω		
c_i Input capacitance		25°C	2.5			2.5	pF		
z_o Open-loop output impedance	$f = 1\text{ MHz}$	25°C	30			30	Ω		
CMRR Common-mode rejection ratio	$V_{IC} = V_{ICRmin}$, $R_S = 50\ \Omega$	25°C	85	118		85	118	dB	
		Full range	80			80			
k_{SVR} Supply-voltage rejection ratio ($\Delta V_{CC\pm}/\Delta V_{IO}$)	$V_{CC\pm} = \pm 2.5\text{ V to } \pm 15\text{ V}$, $R_S = 50\ \Omega$	25°C	90	106		90	106	dB	
		Full range	85			85			
I_{CC} Supply current	$V_O = 2.5\text{ V}$, $V_{IC} = 2.5\text{ V}$, No load,	25°C	6.6	8.8		6.6	8.8	mA	
		Full range			9.2		9.2		

† Full range is -55°C to 125°C.

TLE214x, TLE214xA, TLE214xY
EXCALIBUR LOW-NOISE HIGH-SPEED
PRECISION OPERATIONAL AMPLIFIERS

SLOS183A – FEBRUARY 1997 – REVISED MARCH 1998

TLE2142M operating characteristics, $V_{CC} = 5\text{ V}$, $T_A = 25^\circ\text{C}$

PARAMETER	TEST CONDITIONS	TLE2142M			TLE2142AM			UNIT	
		MIN	TYP	MAX	MIN	TYP	MAX		
SR+	Positive slew rate	$A_{VD} = -1$, $C_L = 500\text{ pF}$		$R_L = 2\text{ k}\Omega^\dagger$		45		V/ μs	
SR-	Negative slew rate					42			
t_s	Settling time	$A_{VD} = -1$, 2.5-V step	To 0.1%		0.16		μs		
			To 0.01%		0.22				
V_n	Equivalent input noise voltage	$R_S = 20\ \Omega$	$f = 10\text{ Hz}$		15		nV/ $\sqrt{\text{Hz}}$		
			$f = 1\text{ kHz}$		10.5				
$V_{N(PP)}$	Peak-to-peak equivalent input noise voltage	$f = 0.1\text{ Hz to }1\text{ Hz}$		0.48		0.48		μV	
		$f = 0.1\text{ Hz to }10\text{ Hz}$		0.51		0.51			
I_n	Equivalent input noise current	$f = 10\text{ Hz}$		1.92		1.92		pA/ $\sqrt{\text{Hz}}$	
		$f = 1\text{ kHz}$		0.5		0.5			
THD + N	Total harmonic distortion plus noise	$V_O = 1\text{ V to }3\text{ V}$, $A_{VD} = 2$,	$R_L = 2\text{ k}\Omega^\dagger$, $f = 10\text{ kHz}$		0.0052%		0.0052%		
B_1	Unity-gain bandwidth	$R_L = 2\text{ k}\Omega^\dagger$,	$C_L = 100\text{ pF}$		5.9		5.9		MHz
	Gain-bandwidth product	$R_L = 2\text{ k}\Omega^\dagger$, $f = 100\text{ kHz}$	$C_L = 100\text{ pF}$		5.8		5.8		MHz
BOM	Maximum output-swing bandwidth	$V_{O(PP)} = 2\text{ V}$, $A_{VD} = 1$,	$R_L = 2\text{ k}\Omega^\dagger$, $C_L = 100\text{ pF}$		660		660		kHz
ϕ_m	Phase margin	$R_L = 2\text{ k}\Omega^\dagger$,	$C_L = 100\text{ pF}$		57°		57°		

$^\dagger R_L$ terminates at 2.5 V.



TLE214x, TLE214xA, TLE214xY
EXCALIBUR LOW-NOISE HIGH-SPEED
PRECISION OPERATIONAL AMPLIFIERS

SLOS183A – FEBRUARY 1997 – REVISED MARCH 1998

TLE2142M electrical characteristics at specified free-air temperature, $V_{CC\pm} = \pm 15\text{ V}$ (unless otherwise noted)

PARAMETER	TEST CONDITIONS	T_A †	TLE2142M			TLE2142AM			UNIT
			MIN	TYP	MAX	MIN	TYP	MAX	
V_{IO} Input offset voltage	$V_{IC} = 0, R_S = 50\ \Omega$	25°C	290	1200		275	750	μV	
		Full range			2000		1600		
α_{VIO} Temperature coefficient of input offset voltage		Full range	1.7			1.7		$\mu\text{V}/^\circ\text{C}$	
I_{IO} Input offset current		25°C	7	100		7	100	nA	
		Full range			250		250		
I_{IB} Input bias current		25°C	-0.7	-1.5		-0.7	-1.5	μA	
	Full range			-1.8		-1.8			
V_{ICR} Common-mode input voltage range	$R_S = 50\ \Omega$	25°C	-15 to 13	-15.3 to 13.2		-15 to 13	-15.3 to 13.2	V	
		Full range	-15 to 12.7	-15.3 to 12.9		-15 to 12.7	-15.3 to 12.9		
V_{OM+} Maximum positive peak output voltage swing	$I_O = -150\ \mu\text{A}$	25°C	13.8	14.1		13.8	14.1	V	
	$I_O = -1.5\ \text{mA}$		13.7	14		13.7	14		
	$I_O = -15\ \text{mA}$		13.3	13.7		13.3	13.7		
	$I_O = -100\ \mu\text{A}$	Full range	13.7			13.7			
	$I_O = -1\ \text{mA}$		13.6			13.6			
	$I_O = -10\ \text{mA}$		13.3			13.3			
V_{OM-} Maximum negative peak output voltage swing	$I_O = 150\ \mu\text{A}$	25°C	-14.7	-14.9		-14.7	-14.9	V	
	$I_O = 1.5\ \text{mA}$		-14.5	-14.8		-14.5	-14.8		
	$I_O = 15\ \text{mA}$		-13.4	-13.8		-13.4	-13.8		
	$I_O = 100\ \mu\text{A}$	Full range	-14.6			-14.6			
	$I_O = 1\ \text{mA}$		-14.5			-14.5			
	$I_O = 10\ \text{mA}$		-13.4			-13.4			
A_{VD} Large-signal differential voltage amplification	$V_O = \pm 10\ \text{V}, R_L = 2\ \text{k}\Omega$	25°C	100	450		100	450	V/mV	
		Full range	20			20			
r_i Input resistance		25°C	65			65	M Ω		
c_i Input capacitance		25°C	2.5			2.5	pF		
z_o Open-loop output impedance	$f = 1\ \text{MHz}$	25°C	30			30	Ω		
CMRR Common-mode rejection ratio	$V_{IC} = V_{ICR\text{min}}, R_S = 50\ \Omega$	25°C	85	108		85	108	dB	
		Full range	80			80			
k_{SVR} Supply-voltage rejection ratio ($\Delta V_{CC\pm} / \Delta V_{IO}$)	$V_{CC\pm} = \pm 2.5\ \text{V to } \pm 15\ \text{V}, R_S = 50\ \Omega$	25°C	90	106		90	106	dB	
		Full range	85			85			
I_{OS} Short-circuit output current	$V_O = 0$	25°C	$V_{ID} = 1\ \text{V}$	-25	-50		-25	-50	mA
			$V_{ID} = -1\ \text{V}$	20	31		20	31	
I_{CC} Supply current	$V_O = 0, V_{IC} = 2.5\ \text{V}$	25°C	6.9	9		6.9	9	mA	
		Full range			9.4		9.4		

† Full range is -55°C to 125°C .



TLE214x, TLE214xA, TLE214xY
EXCALIBUR LOW-NOISE HIGH-SPEED
PRECISION OPERATIONAL AMPLIFIERS

SLOS183A – FEBRUARY 1997 – REVISED MARCH 1998

TLE2142M operating characteristics, $V_{CC\pm} = \pm 15\text{ V}$, $T_A = 25^\circ\text{C}$

PARAMETER	TEST CONDITIONS	TLE2142M			TLE2142AM			UNIT	
		MIN	TYP	MAX	MIN	TYP	MAX		
SR+	Positive slew rate	$R_L = 2\text{ k}\Omega$, $C_L = 100\text{ pF}$		$A_{VD} = -1$,	27	45	27	45	V/ μs
SR-	Negative slew rate				27	42	27	42	
t_s	Settling time	$A_{VD} = -1$, 10-V step		To 0.1%	0.34			μs	
					To 0.01%	0.4			
V_n	Equivalent input noise voltage	$R_S = 20\ \Omega$, $f = 10\text{ Hz}$		15		15		nV/ $\sqrt{\text{Hz}}$	
		$R_S = 20\ \Omega$, $f = 1\text{ kHz}$		10.5		10.5			
$V_{N(PP)}$	Peak-to-peak equivalent input noise voltage	$f = 0.1\text{ Hz to }1\text{ Hz}$		0.48		0.48		μV	
		$f = 0.1\text{ Hz to }10\text{ Hz}$		0.51		0.51			
I_n	Equivalent input noise current	$f = 10\text{ Hz}$		1.89		1.89		pA/ $\sqrt{\text{Hz}}$	
		$f = 1\text{ kHz}$		0.47		0.47			
THD + N	Total harmonic distortion plus noise	$V_{O(PP)} = 20\text{ V}$, $R_L = 2\text{ k}\Omega$, $A_{VD} = 10$, $f = 10\text{ kHz}$		0.01%		0.01%			
B_1	Unity-gain bandwidth	$R_L = 2\text{ k}\Omega$, $C_L = 100\text{ pF}$		6		6		MHz	
	Gain-bandwidth product	$R_L = 2\text{ k}\Omega$, $C_L = 100\text{ pF}$, $f = 100\text{ kHz}$		5.9		5.9		MHz	
B_{OM}	Maximum output-swing bandwidth	$V_{O(PP)} = 20\text{ V}$, $R_L = 2\text{ k}\Omega$, $A_{VD} = 1$, $C_L = 100\text{ pF}$		668		668		kHz	
ϕ_m	Phase margin at unity gain	$R_L = 2\text{ k}\Omega$, $C_L = 100\text{ pF}$		58°		58°			



TLE214x, TLE214xA, TLE214xY
EXCALIBUR LOW-NOISE HIGH-SPEED
PRECISION OPERATIONAL AMPLIFIERS

SLOS183A – FEBRUARY 1997 – REVISED MARCH 1998

TLE2144M electrical characteristics at specified free-air temperature, $V_{CC} = 5\text{ V}$ (unless otherwise noted)

PARAMETER	TEST CONDITIONS	T_A †	TLE2144M			TLE2144AM			UNIT
			MIN	TYP	MAX	MIN	TYP	MAX	
V_{IO} Input offset voltage	$V_O = 2.5\text{ V},$ $V_{IC} = 2.5\text{ V}$ $R_S = 50\ \Omega,$	25°C	0.5	3.8		0.5	3	mV	
		Full range			5.2		4.4		
α_{VIO} Temperature coefficient of input offset voltage		Full range	1.7			1.7		$\mu\text{V}/^\circ\text{C}$	
I_{IO} Input offset current		25°C	8	100		8	100	nA	
		Full range			250		250		
I_{IB} Input bias current		25°C	-0.8	-2		-0.8	-2	μA	
	Full range			-2.3		-2.3			
V_{ICR} Common-mode input voltage range	$R_S = 50\ \Omega$	25°C	0 to 3	-0.3 to 3.2		0 to 3	-0.3 to 3.2	V	
		Full range	0 to 2.7	-0.3 to 2.9		0 to 2.7	-0.3 to 2.9		
V_{OH} High-level output voltage	$I_{OH} = -150\ \mu\text{A}$	25°C	3.9	4.1		3.9	4.1	V	
	$I_{OH} = -1.5\text{ mA}$		3.8	4		3.8	4		
	$I_{OH} = -15\text{ mA}$		3.4	3.7		3.4	3.7		
	$I_{OH} = 100\ \mu\text{A}$	Full range	3.75			3.75			
	$I_{OH} = 1\text{ mA}$		3.65			3.65			
	$I_{OH} = 10\text{ mA}$		3.45			3.45			
V_{OL} Low-level output voltage	$I_{OL} = 150\ \mu\text{A}$	25°C	75	125		75	125	mV	
	$I_{OL} = 1.5\ \mu\text{A}$		150	225		150	225		
	$I_{OL} = 15\text{ mA}$		1.2	1.6		1.2	1.6	V	
	$I_{OL} = 100\ \mu\text{A}$	Full range	200			200		mV	
	$I_{OL} = 1\text{ mA}$		250			250			
	$I_{OL} = 10\text{ mA}$		1.45			1.45		V	
A_{VD} Large-signal differential voltage amplification	$V_{IC} = \pm 2.5\text{ V},$ $V_O = 1\text{ V to } -1.5\text{ V}$ $R_L = 2\text{ k}\Omega,$	25°C	50	95		50	95	V/mV	
		Full range	5			5			
r_i Input resistance		25°C	70			70	M Ω		
c_i Input capacitance		25°C	2.5			2.5	pF		
z_o Open-loop output impedance	$f = 1\text{ MHz}$	25°C	30			30	Ω		
CMRR Common-mode rejection ratio	$V_{IC} = V_{ICRmin},$ $R_S = 50\ \Omega$	25°C	85	118		85	118	dB	
		Full range	80			80			
k_{SVR} Supply-voltage rejection ratio ($\Delta V_{CC\pm}/\Delta V_{IO}$)	$V_{CC\pm} = \pm 2.5\text{ V to } \pm 15\text{ V},$ $R_S = 50\ \Omega$	25°C	90	106		90	106	dB	
		Full range	85			85			
I_{CC} Supply current	$V_O = 2.5\text{ V},$ $V_{IC} = 2.5\text{ V}$ No load,	25°C	13.2	17.6		13.2	17.6	mA	
		Full range			18.4		18.4		

† Full range is -55°C to 125°C .



TLE214x, TLE214xA, TLE214xY
EXCALIBUR LOW-NOISE HIGH-SPEED
PRECISION OPERATIONAL AMPLIFIERS

SLOS183A – FEBRUARY 1997 – REVISED MARCH 1998

TLE2144M operating characteristics, $V_{CC} = 5\text{ V}$, $T_A = 25^\circ\text{C}$

PARAMETER	TEST CONDITIONS	TLE2144M			TLE2144AM			UNIT		
		MIN	TYP	MAX	MIN	TYP	MAX			
SR+	Positive slew rate	$A_{VD} = -1$, $C_L = 500\text{ pF}$		$R_L = 2\text{ k}\Omega^\dagger$		45		V/ μs		
SR-	Negative slew rate					42				
t_s	Settling time	$A_{VD} = -1$, 2.5-V step	To 0.1%		0.16		μs			
			To 0.01%		0.22					
V_n	Equivalent input noise voltage	$R_S = 20\ \Omega$, $f = 10\text{ Hz}$	15		15		nV/ $\sqrt{\text{Hz}}$			
		$R_S = 20\ \Omega$, $f = 1\text{ kHz}$	10.5		10.5					
$V_{N(PP)}$	Peak-to-peak equivalent input noise voltage	f = 0.1 Hz to 1 Hz		0.48		0.48		μV		
		f = 0.1 Hz to 10 Hz		0.51		0.51				
I_n	Equivalent input noise current	f = 10 Hz		1.92		1.92		pA/ $\sqrt{\text{Hz}}$		
		f = 1 kHz		0.5		0.5				
THD + N	Total harmonic distortion plus noise	$V_O = 1\text{ V to }3\text{ V}$, $A_{VD} = 2$, $f = 10\text{ kHz}$		$R_L = 2\text{ k}\Omega^\dagger$		0.0052%		0.0052%		
B_1	Unity-gain bandwidth	$R_L = 2\text{ k}\Omega^\dagger$	$C_L = 100\text{ pF}$		5.9		5.9		MHz	
	Gain-bandwidth product	$R_L = 2\text{ k}\Omega^\dagger$, f = 100 kHz	$C_L = 100\text{ pF}$		5.8		5.8		MHz	
BOM	Maximum output-swing bandwidth	$V_{O(PP)} = 2\text{ V}$, $A_{VD} = 1$		$R_L = 2\text{ k}\Omega^\dagger$		660		660		kHz
ϕ_m	Phase margin	$R_L = 2\text{ k}\Omega^\dagger$	$C_L = 100\text{ pF}$		57°		57°			

$\dagger R_L$ terminates at 2.5 V



TLE214x, TLE214xA, TLE214xY
EXCALIBUR LOW-NOISE HIGH-SPEED
PRECISION OPERATIONAL AMPLIFIERS

SLOS183A – FEBRUARY 1997 – REVISED MARCH 1998

TLE2144M electrical characteristics at specified free-air temperature, $V_{CC\pm} = \pm 15\text{ V}$ (unless otherwise noted)

PARAMETER	TEST CONDITIONS	T_A †	TLE2144M			TLE2144AM			UNIT
			MIN	TYP	MAX	MIN	TYP	MAX	
V_{IO} Input offset voltage	$V_{IC} = 0, R_S = 50\ \Omega$	25°C	0.6 2.4		0.5 1.5		mV		
		Full range	4		3.2				
α_{VIO} Temperature coefficient of input offset voltage		Full range	1.7		1.7		$\mu\text{V}/^\circ\text{C}$		
I_{IO} Input offset current		25°C	7 100		7 100		nA		
		Full range	250		250				
I_{IB} Input bias current		25°C	-0.7 -1.5		-0.7 -1.5		μA		
	Full range	-1.8		-1.8					
V_{ICR} Common-mode input voltage range	$R_S = 50\ \Omega$	25°C	-15 to 13	-15.3 to 13.2	-15 to 13	-15.3 to 13.2	V		
		Full range	-15 to 12.7	-15.3 to 12.9	-15 to 12.7	-15.3 to 12.9			
V_{OM+} Maximum positive peak output voltage swing	$I_O = -150\ \mu\text{A}$	25°C	13.8	14.1	13.8	14.1	V		
	$I_O = -1.5\ \text{mA}$		13.7	14	13.7	14			
	$I_O = -15\ \text{mA}$		13.1	13.7	13.1	13.7			
	$I_O = -100\ \mu\text{A}$	Full range	13.7		13.7				
	$I_O = -1\ \text{mA}$		13.6		13.6				
	$I_O = -10\ \text{mA}$		13.1		13.1				
V_{OM-} Maximum negative peak output voltage swing	$I_O = 150\ \mu\text{A}$	25°C	-14.7	-14.9	-14.7	-14.9	V		
	$I_O = 1.5\ \text{mA}$		-14.5	-14.8	-14.5	-14.8			
	$I_O = 15\ \text{mA}$		-13.4	-13.8	-13.4	-13.8			
	$I_O = 100\ \mu\text{A}$	Full range	-14.6		-14.6				
	$I_O = 1\ \text{mA}$		-14.5		-14.5				
	$I_O = 10\ \text{mA}$		-13.4		-13.4				
A_{VD} Large-signal differential voltage amplification	$V_O = \pm 10\ \text{V}, R_L = 2\ \text{k}\Omega$	25°C	100	170	100	170	V/mV		
		Full range	20		20				
r_i Input resistance		25°C	65			$\text{M}\Omega$			
c_i Input capacitance		25°C	2.5			pF			
z_o Open-loop output impedance	$f = 1\ \text{MHz}$	25°C	30			Ω			
CMRR Common-mode rejection ratio	$V_{IC} = V_{ICRmin}, R_S = 50\ \Omega$	25°C	85	108	85	108	dB		
		Full range	80		80				
k_{SVR} Supply-voltage rejection ratio ($\Delta V_{CC\pm}/\Delta V_{IO}$)	$V_{CC\pm} = \pm 2.5\ \text{V to } \pm 15\ \text{V}, R_S = 50\ \Omega$	25°C	90	106	90	106	dB		
		Full range	85		85				
I_{OS} Short-circuit output current	$V_O = 0$	25°C	$V_{ID} = 1\ \text{V}$	-25	-50	-25	-50	mA	
			$V_{ID} = -1\ \text{V}$	20	31	20	31		
I_{CC} Supply current	$V_O = 0, V_{IC} = 2.5\ \text{V}$	25°C	13.8 18		13.8 18		mA		
			Full range	18.8		18.8			

† Full range is -55°C to 125°C

TLE214x, TLE214xA, TLE214xY
EXCALIBUR LOW-NOISE HIGH-SPEED
PRECISION OPERATIONAL AMPLIFIERS

SLOS183A – FEBRUARY 1997 – REVISED MARCH 1998

TLE2144M operating characteristics, $V_{CC\pm} = \pm 15\text{ V}$, $T_A = 25^\circ\text{C}$

PARAMETER	TEST CONDITIONS	TLE2144M			TLE2144AM			UNIT		
		MIN	TYP	MAX	MIN	TYP	MAX			
SR+	Positive slew rate	$R_L = 2\text{ k}\Omega$, $C_L = 100\text{ pF}$		$A_{VD} = -1$,		27	45	27	45	V/ μs
SR-	Negative slew rate					27	42	27	42	
t_s	Settling time	$A_{VD} = -1$, 10-V step		To 0.1%		0.34		0.34		μs
						To 0.01%		.4		
V_n	Equivalent input noise voltage	$R_S = 20\ \Omega$, $f = 10\text{ Hz}$		15		15		nV/ $\sqrt{\text{Hz}}$		
		$R_S = 20\ \Omega$, $f = 1\text{ kHz}$		10.5		10.5				
$V_{N(PP)}$	Peak-to-peak equivalent input noise voltage	$f = 0.1\text{ Hz to }1\text{ Hz}$		0.48		0.48		μV		
		$f = 0.1\text{ Hz to }10\text{ Hz}$		0.51		0.51				
I_n	Equivalent input noise current	$f = 10\text{ Hz}$		1.89		1.89		pA/ $\sqrt{\text{Hz}}$		
		$f = 10\text{ kHz}$		0.47		0.47				
THD + N	Total harmonic distortion plus noise	$V_{O(PP)} = 20\text{ V}$, $A_{VD} = 10$,		$R_L = 2\text{ k}\Omega$, $f = 10\text{ kHz}$		0.01%		0.01%		
B_1	Unity-gain bandwidth	$R_L = 2\text{ k}\Omega$,		$C_L = 100\text{ pF}$		6		6		MHz
	Gain-bandwidth product	$R_L = 2\text{ k}\Omega$, $f = 100\text{ kHz}$		$C_L = 100\text{ pF}$,		5.9		5.9		MHz
B_{OM}	Maximum output-swing bandwidth	$V_{O(PP)} = 20\text{ V}$, $A_{VD} = 1$,		$R_L = 2\text{ k}\Omega$, $C_L = 100\text{ pF}$		668		668		kHz
ϕ_m	Phase margin at unity gain	$R_L = 2\text{ k}\Omega$,		$C_L = 100\text{ pF}$		58°		58°		



TLE214x, TLE214xA, TLE214xY
EXCALIBUR LOW-NOISE HIGH-SPEED
PRECISION OPERATIONAL AMPLIFIERS

SLOS183A – FEBRUARY 1997 – REVISED MARCH 1998

TLE2141Y electrical characteristics at specified free-air temperature, $V_{CC\pm} = \pm 15\text{ V}$, $T_A = 25^\circ\text{C}$ (unless otherwise noted)

PARAMETER		TEST CONDITIONS	TLE2141Y			UNIT
			MIN	TYP	MAX	
V_{IO}	Input offset voltage	$V_{IC} = 0,$ $V_O = 0$ $R_S = 50\ \Omega,$		200	1000	μV
I_{IO}	Input offset current			7	100	nA
I_{IB}	Input bias current			-0.7	-1.5	μA
V_{ICR}	Common-mode input voltage range	$R_S = 50\ \Omega$	-15 to 13	-15.3 to 13.2		V
V_{OM+}	Maximum positive peak output voltage swing	$I_O = -150\ \mu\text{A}$	13.8	14.1	V	
		$I_O = -1.5\ \text{mA}$	13.7	14		
		$I_O = -15\ \text{mA}$	13.3	13.7		
V_{OM-}	Maximum negative peak output voltage swing	$I_O = 150\ \mu\text{A}$	-14.7	-14.9	V	
		$I_O = 1.5\ \text{mA}$	-14.5	-14.8		
		$I_O = 15\ \text{mA}$	-13.4	-13.8		
A_{VD}	Large-signal differential voltage amplification	$V_O = \pm 10\ \text{V},$ $R_L = 2\ \text{k}\Omega$	100	450		V/mV
r_i	Input resistance			65		M Ω
c_i	Input capacitance			2.5		pF
z_o	Open-loop output impedance	$f = 1\ \text{MHz}$		30		Ω
CMRR	Common-mode rejection ratio	$V_{IC} = V_{ICRmin},$ $R_S = 50\ \Omega$	80	108		dB
k_{SVR}	Supply-voltage rejection ratio ($\Delta V_{CC\pm}/\Delta V_{IO}$)	$V_{CC\pm} = \pm 2.5\ \text{V to } \pm 15\ \text{V},$ $R_S = 50\ \Omega$	85	106		dB
I_{OS}	Short-circuit output current	$V_O = 0$	$V_{ID} = 1\ \text{V}$	-25	-50	mA
			$V_{ID} = -1\ \text{V}$	20	31	
I_{CC}	Supply current	$V_O = 0,$ No load		3.5	4.5	mA

TLE214x, TLE214xA, TLE214xY
EXCALIBUR LOW-NOISE HIGH-SPEED
PRECISION OPERATIONAL AMPLIFIERS

SLOS183A – FEBRUARY 1997 – REVISED MARCH 1998

TLE2142Y electrical characteristics at specified free-air temperature, $V_{CC\pm} = \pm 15\text{ V}$, $T_A = 25^\circ\text{C}$

PARAMETER	TEST CONDITIONS	TLE2142Y			UNIT
		MIN	TYP	MAX	
V_{IO} Input offset voltage	$V_{IC} = 0$, $R_S = 50\ \Omega$, $V_O = 0$		150	875	μV
I_{IO} Input offset current			7	100	nA
I_{IB} Input bias current			-0.7	-1.5	μA
V_{ICR} Common-mode input voltage range	$R_S = 50\ \Omega$	-15 to 13	-15.3 to 13.2		V
V_{OM+} Maximum positive peak output voltage swing	$I_O = -150\ \mu\text{A}$	13.8	14.1		V
	$I_O = -1.5\ \text{mA}$	13.7	14		
	$I_O = -15\ \text{mA}$	13.3	13.7		
V_{OM-} Maximum negative peak output voltage swing	$I_O = 150\ \mu\text{A}$	-14.7	-14.9		V
	$I_O = 1.5\ \text{mA}$	-14.5	-14.8		
	$I_O = 15\ \text{mA}$	-13.4	-13.8		
A_{VD} Large-signal differential voltage amplification	$V_O = \pm 10\ \text{V}$, $R_L = 2\ \text{k}\Omega$	100	450		V/mV
r_i Input resistance			65		$\text{M}\Omega$
c_i Input capacitance			2.5		pF
z_o Open-loop output impedance	$f = 1\ \text{MHz}$		30		Ω
CMRR Common-mode rejection ratio	$V_{IC} = V_{ICRmin}$, $R_S = 50\ \Omega$	80	108		dB
k_{SVR} Supply-voltage rejection ratio ($\Delta V_{CC\pm} / \Delta V_{IO}$)	$V_{CC\pm} = \pm 2.5\ \text{V}$ to $\pm 15\ \text{V}$, $R_S = 50\ \Omega$	85	106		dB
I_{OS} Short-circuit output current	$V_O = 0$	$V_{ID} = 1\ \text{V}$	-25	-50	mA
		$V_{ID} = -1\ \text{V}$	20	31	
I_{CC} Supply current	$V_O = 0$, No load		6.9	9	mA



TLE214x, TLE214xA, TLE214xY
EXCALIBUR LOW-NOISE HIGH-SPEED
PRECISION OPERATIONAL AMPLIFIERS

SLOS183A – FEBRUARY 1997 – REVISED MARCH 1998

TLE2144Y electrical characteristics at $V_{CC\pm} = \pm 15\text{ V}$, $T_A = 25^\circ\text{C}$ (unless otherwise noted)

PARAMETER	TEST CONDITIONS	TLE2144Y			UNIT
		MIN	TYP	MAX	
V_{IO} Input offset voltage	$V_{IC} = 0$, $V_O = 0$ $R_S = 50\ \Omega$,	0.3	1.8		mV
I_{IO} Input offset current		7	100		nA
I_{IB} Input bias current		-0.7	-1.5		μA
V_{ICR} Common-mode input voltage range	$R_S = 50\ \Omega$	-15 to 13	-15.3 to 13.2		V
V_{OM+} Maximum positive peak output voltage swing	$I_O = -150\ \mu\text{A}$	13.8	14.1		V
	$I_O = -1.5\ \text{mA}$	13.7	14		
	$I_O = -15\ \text{mA}$	13.3	13.7		
V_{OM-} Maximum negative peak output voltage swing	$I_O = 150\ \mu\text{A}$	-14.7	-14.9		V
	$I_O = 1.5\ \text{mA}$	-14.5	-14.8		
	$I_O = 15\ \text{mA}$	-13.4	-13.8		
A_{VD} Large-signal differential voltage amplification	$V_O = \pm 10\ \text{V}$, $R_L = 2\ \text{k}\Omega$	100	450		V/mV
r_i Input resistance		65			M Ω
c_i Input capacitance		2.5			pF
z_o Open-loop output impedance	$f = 1\ \text{MHz}$	30			Ω
CMRR Common-mode rejection ratio	$V_{IC} = V_{ICRmin}$, $R_S = 50\ \Omega$	80	108		dB
k_{SVR} Supply-voltage rejection ratio ($\Delta V_{CC\pm} / \Delta V_{IO}$)	$V_{CC\pm} = \pm 2.5\ \text{V to } \pm 15\ \text{V}$, $R_S = 50\ \Omega$	85	106		dB
I_{OS} Short-circuit output current	$V_O = 0$	$V_{ID} = 1\ \text{V}$	-25	-50	mA
		$V_{ID} = -1\ \text{V}$	20	31	
I_{CC} Supply current	$V_O = 0$, No load	13.8	18		mA

TLE214x, TLE214xA, TLE214xY
EXCALIBUR LOW-NOISE HIGH-SPEED
PRECISION OPERATIONAL AMPLIFIERS

SLOS183A – FEBRUARY 1997 – REVISED MARCH 1998

TYPICAL CHARACTERISTICS

Table of Graphs

			FIGURE
V_{IO}	Input offset voltage	Distribution	1, 2, 3
I_{IO}	Input offset current	vs Free-air temperature	4
I_{IB}	Input bias current	vs Common-mode input voltage	5
		vs Free-air temperature	6
V_{OM+}	Maximum positive peak output voltage	vs Supply voltage	7
		vs Free-air temperature	8
		vs Output current	9
		vs Settling time	11
V_{OM-}	Maximum negative peak output voltage	vs Supply voltage	7
		vs Free-air temperature	8
		vs Output current	10
		vs Settling time	11
$V_{O(PP)}$	Maximum peak-to-peak output voltage	vs Frequency	12
V_{OH}	High-level output voltage	vs Output current	13
V_{OL}	Low-level output voltage	vs Output current	14
A_{VD}	Large-signal differential voltage amplification	vs Frequency	15
		vs Free-air temperature	16
z_o	Closed-loop output impedance	vs Frequency	17
I_{OS}	Short-circuit output current	vs Free-air temperature	18
CMRR	Common-mode rejection ratio	vs Frequency	19
		vs Free-air temperature	20
k_{SVR}	Supply-voltage rejection ratio	vs Frequency	21
		vs Free-air temperature	22
I_{CC}	Supply current	vs Supply voltage	23
		vs Free-air temperature	24
V_n	Equivalent input noise voltage	vs Frequency	25
V_n	Input noise voltage	Over a 10-second period	26
I_n	Noise current	vs Frequency	27
THD + N	Total harmonic distortion plus noise	vs Frequency	28
SR	Slew rate	vs Free-air temperature	29
		vs Load capacitance	30
Pulse response	Noninverting large signal	vs Time	31
	Inverting large signal	vs Time	32
	Small signal	vs Time	33
B_1	Unity-gain bandwidth	vs Load capacitance	34
	Gain margin	vs Load capacitance	35
ϕ_m	Phase margin	vs Load capacitance	36
	Phase shift	vs Frequency	15



TYPICAL CHARACTERISTICS

TLE2141
DISTRIBUTION OF
INPUT OFFSET VOLTAGE

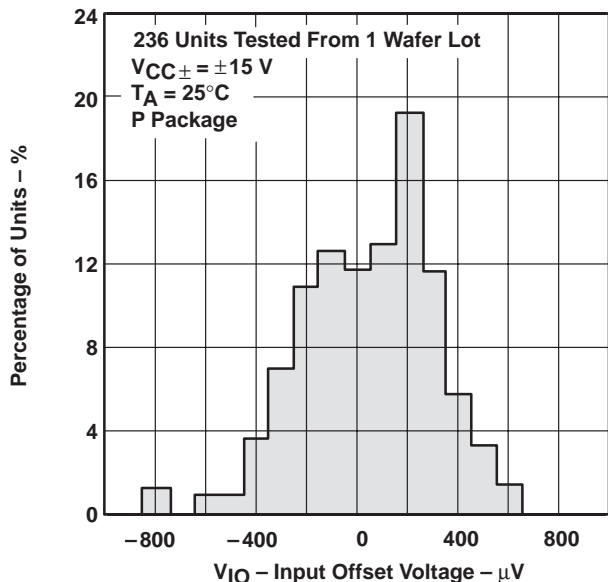

Figure 1

TLE2142
DISTRIBUTION OF
INPUT OFFSET VOLTAGE

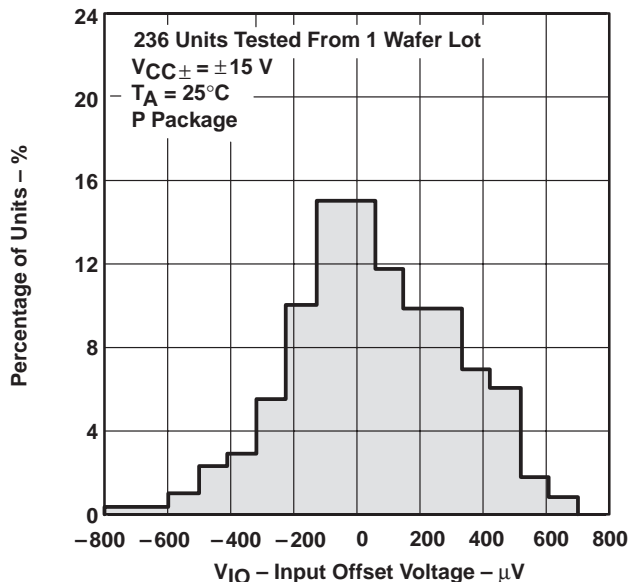

Figure 2

TLE2144
DISTRIBUTION OF
INPUT OFFSET VOLTAGE

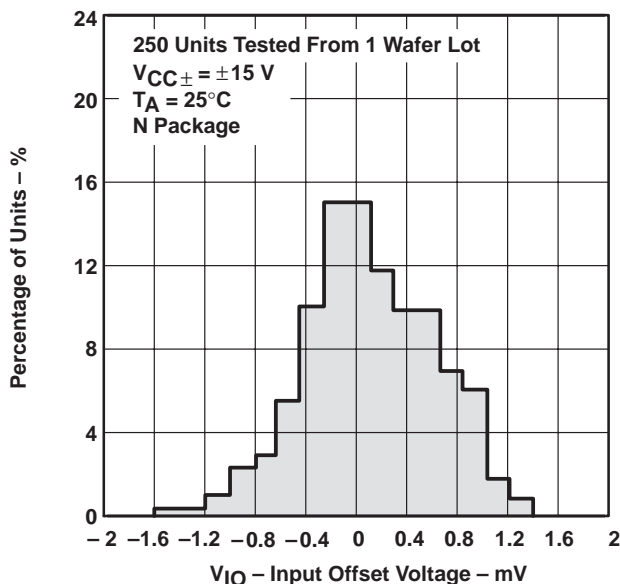

Figure 3

INPUT OFFSET CURRENT†
vs
FREE-AIR TEMPERATURE

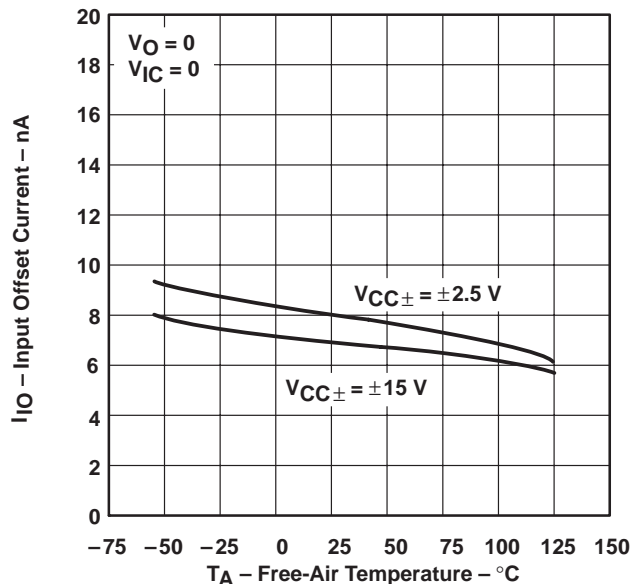

Figure 4

† Data at high and low temperatures are applicable only within the rated operating free-air temperature ranges of the various devices.

TLE214x, TLE214xA, TLE214xY
EXCALIBUR LOW-NOISE HIGH-SPEED
PRECISION OPERATIONAL AMPLIFIERS

SLOS183A – FEBRUARY 1997 – REVISED MARCH 1998

TYPICAL CHARACTERISTICS

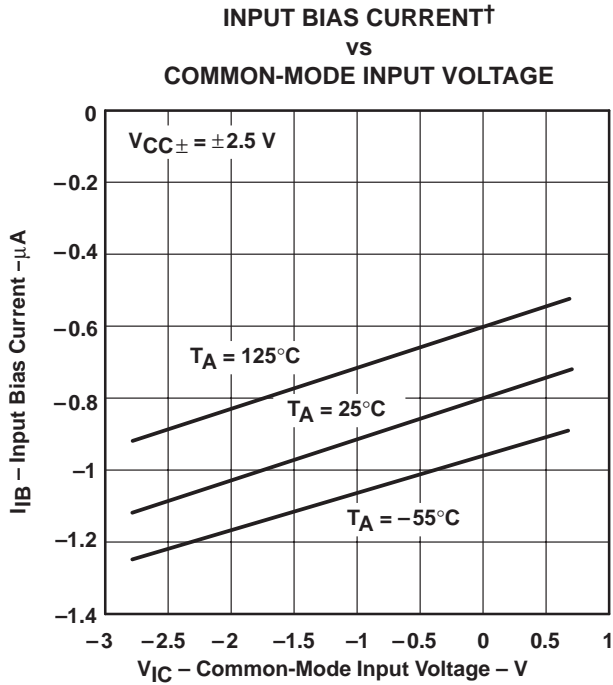

Figure 5

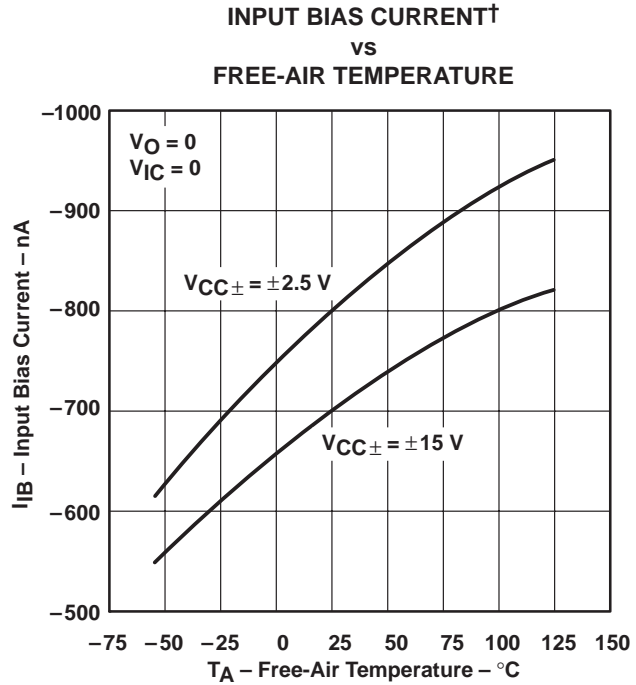

Figure 6

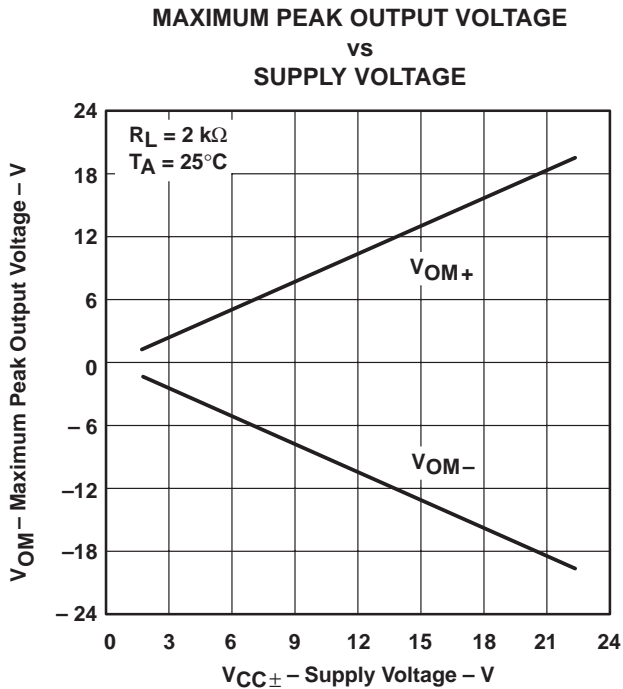

Figure 7

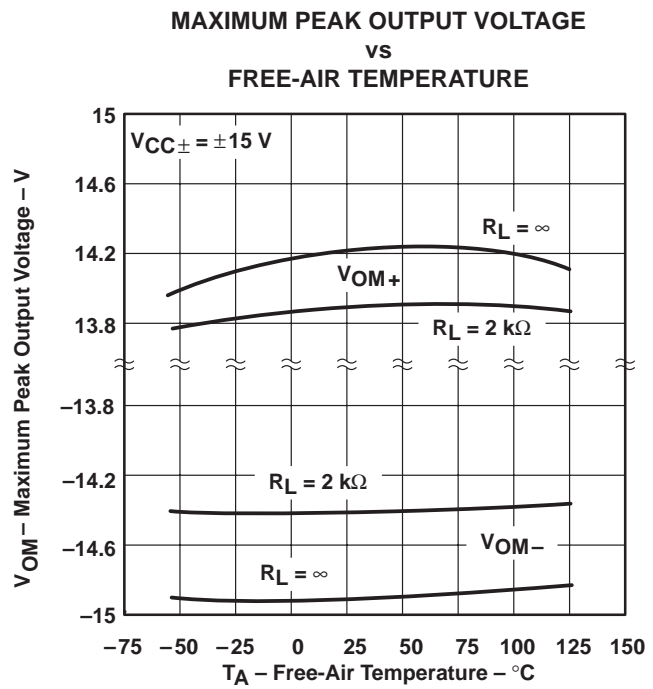

Figure 8

† Data at high and low temperatures are applicable only within the rated operating free-air temperature ranges of the various devices.



TYPICAL CHARACTERISTICS

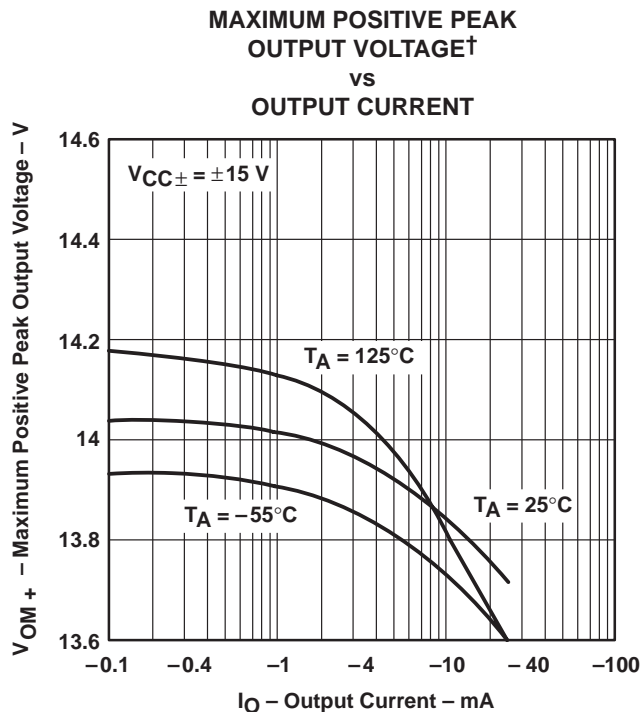

Figure 9

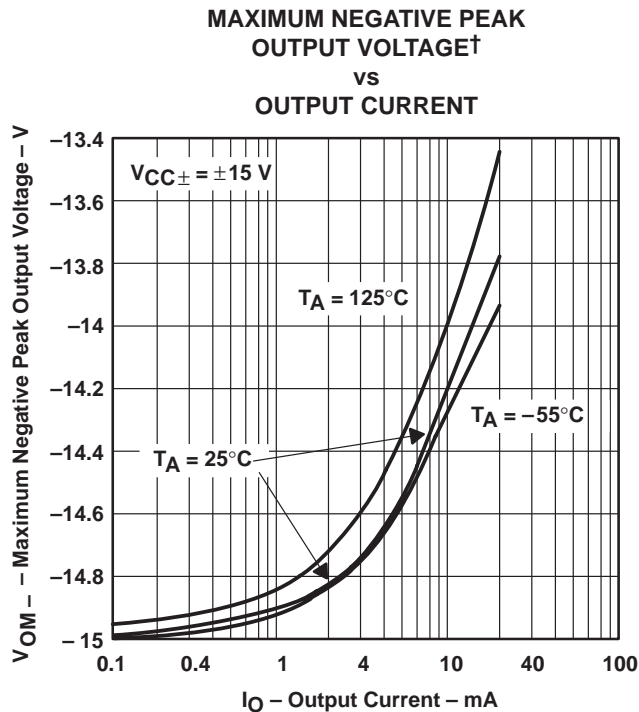

Figure 10

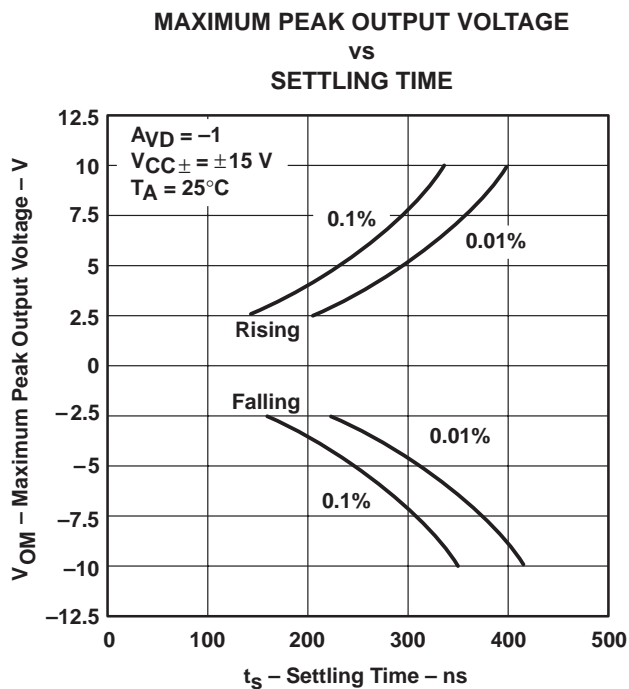

Figure 11

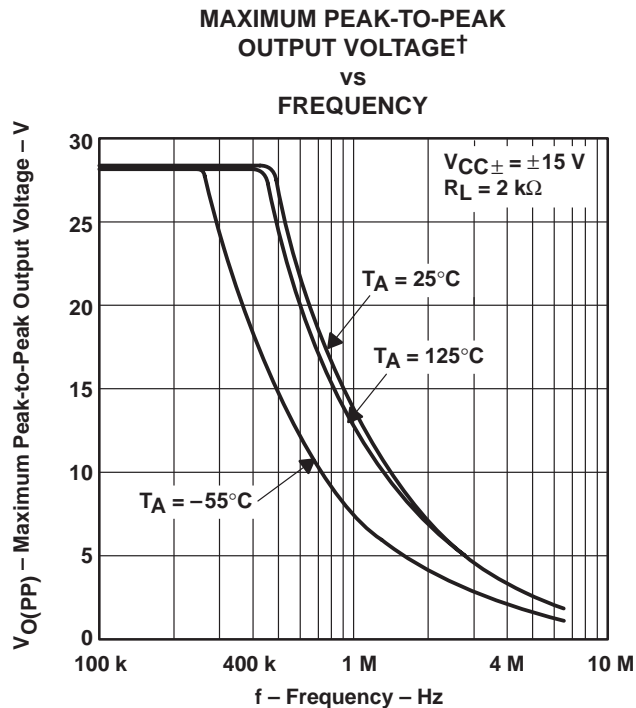

Figure 12

† Data at high and low temperatures are applicable only within the rated operating free-air temperature ranges of the various devices.

TLE214x, TLE214xA, TLE214xY
 EXCALIBUR LOW-NOISE HIGH-SPEED
 PRECISION OPERATIONAL AMPLIFIERS

SLOS183A – FEBRUARY 1997 – REVISED MARCH 1998

TYPICAL CHARACTERISTICS

HIGH-LEVEL OUTPUT VOLTAGE†
 vs
 OUTPUT CURRENT

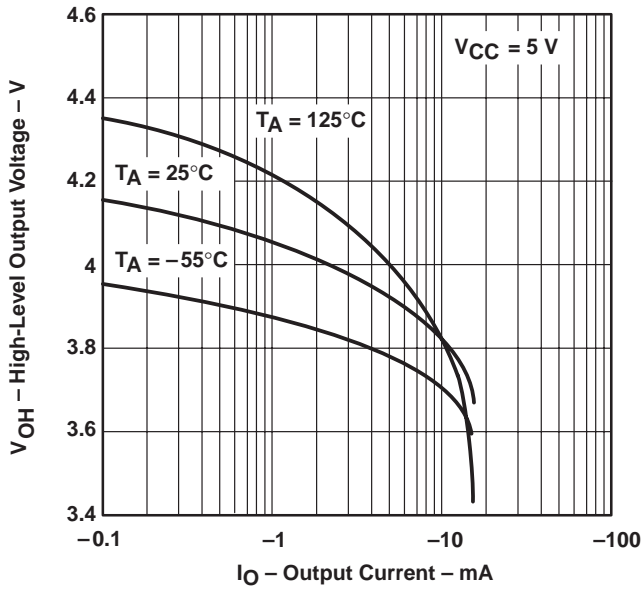

Figure 13

LOW-LEVEL OUTPUT VOLTAGE†
 vs
 OUTPUT CURRENT

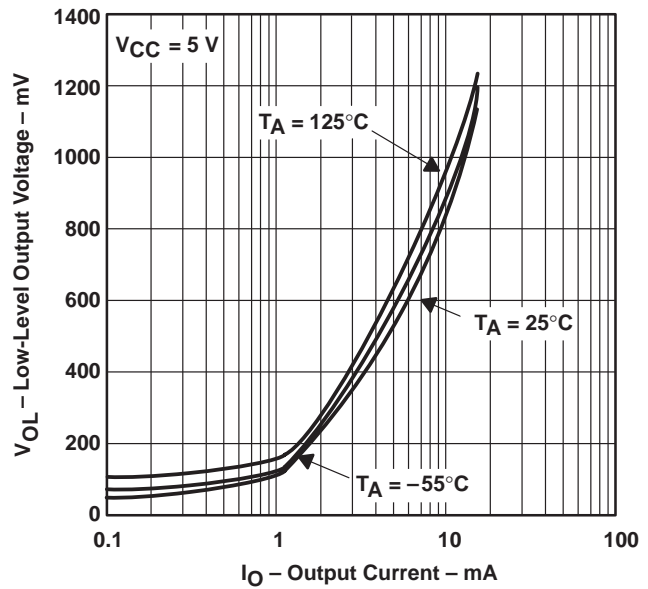

Figure 14

LARGE-SIGNAL DIFFERENTIAL VOLTAGE
 AMPLIFICATION AND PHASE SHIFT
 vs
 FREQUENCY

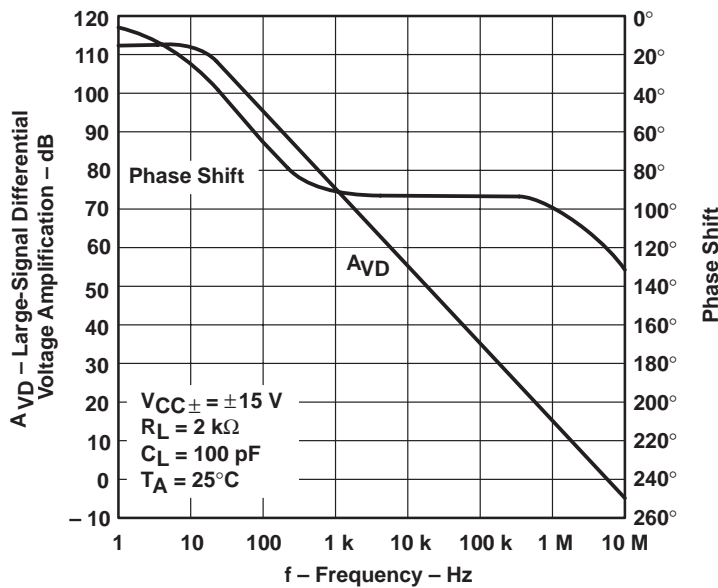

Figure 15

† Data at high and low temperatures are applicable only within the rated operating free-air temperature ranges of the various devices.



TYPICAL CHARACTERISTICS

LARGE-SIGNAL DIFFERENTIAL
 VOLTAGE AMPLIFICATION†

vs
 FREE-AIR TEMPERATURE

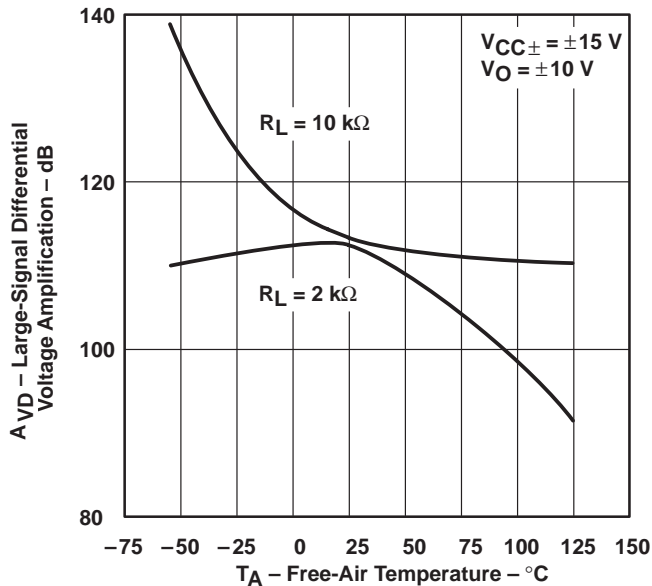

Figure 16

CLOSED-LOOP OUTPUT IMPEDANCE
 vs
 FREQUENCY

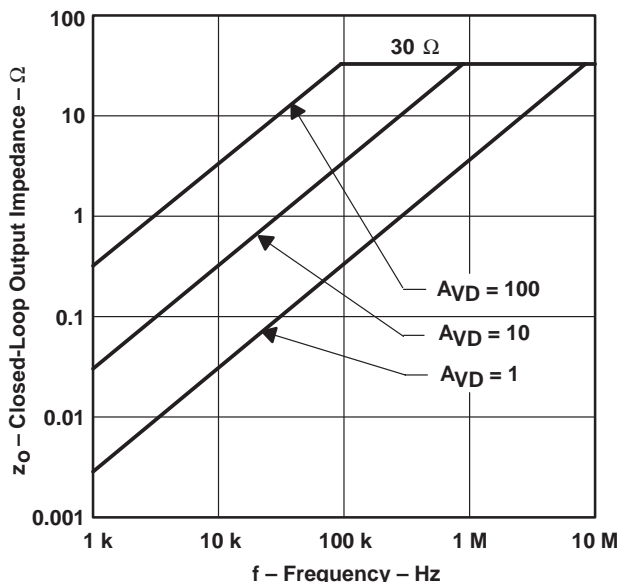

Figure 17

SHORT-CIRCUIT OUTPUT CURRENT†
 vs
 FREE-AIR TEMPERATURE

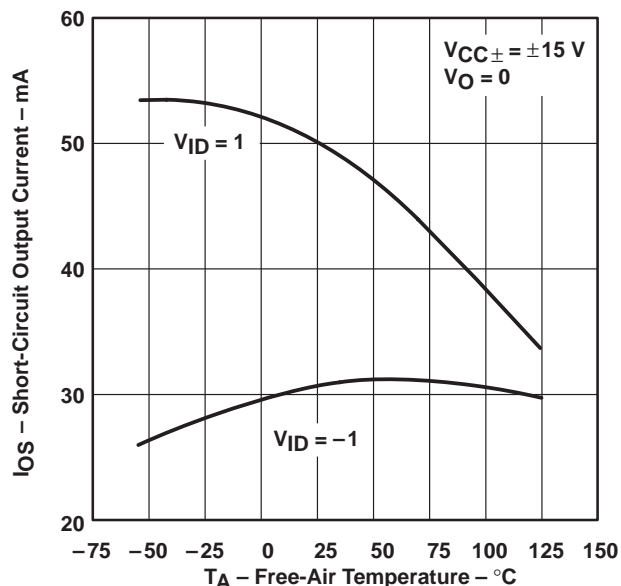

Figure 18

† Data at high and low temperatures are applicable only within the rated operating free-air temperature ranges of the various devices.

TLE214x, TLE214xA, TLE214xY
EXCALIBUR LOW-NOISE HIGH-SPEED
PRECISION OPERATIONAL AMPLIFIERS

SLOS183A – FEBRUARY 1997 – REVISED MARCH 1998

TYPICAL CHARACTERISTICS

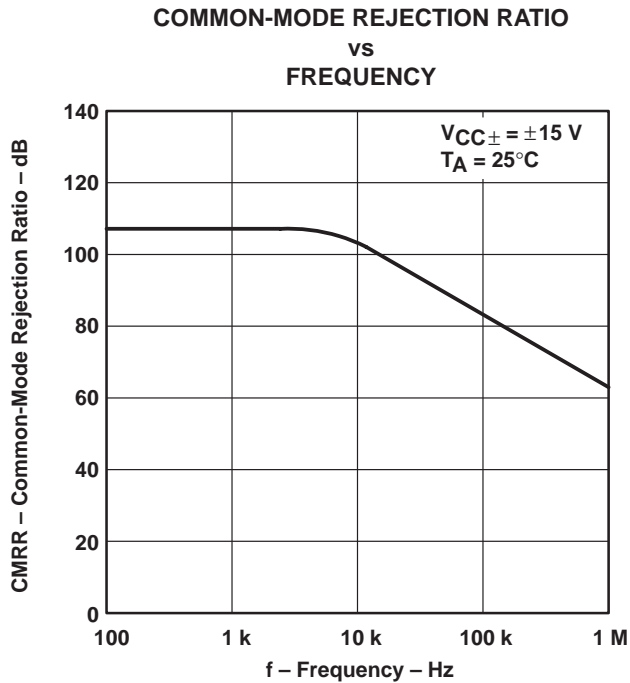

Figure 19

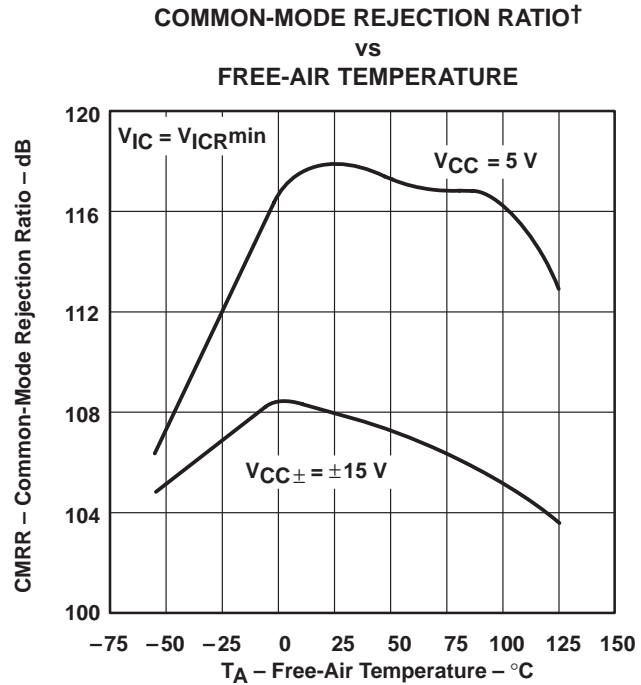

Figure 20

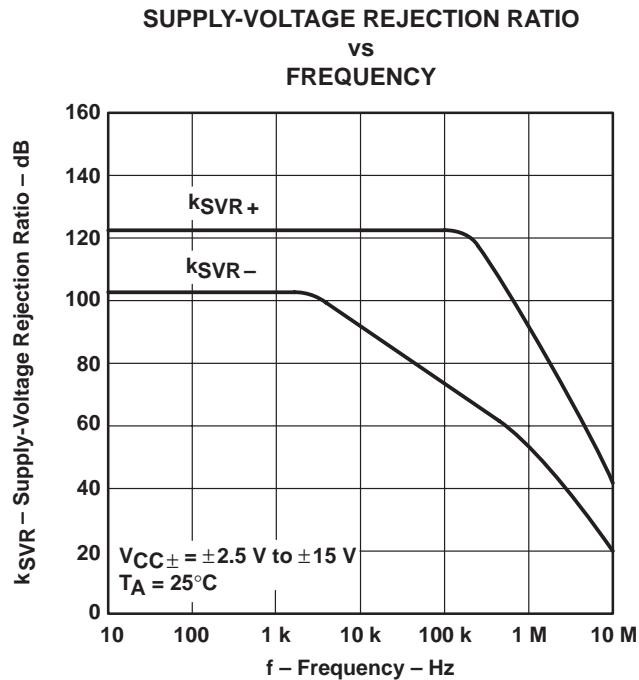

Figure 21

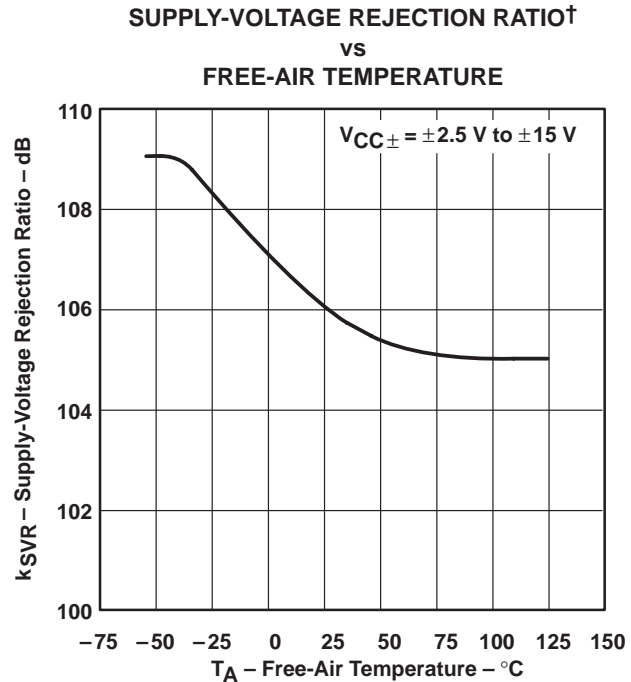

Figure 22

† Data at high and low temperatures are applicable only within the rated operating free-air temperature ranges of the various devices.

TYPICAL CHARACTERISTICS

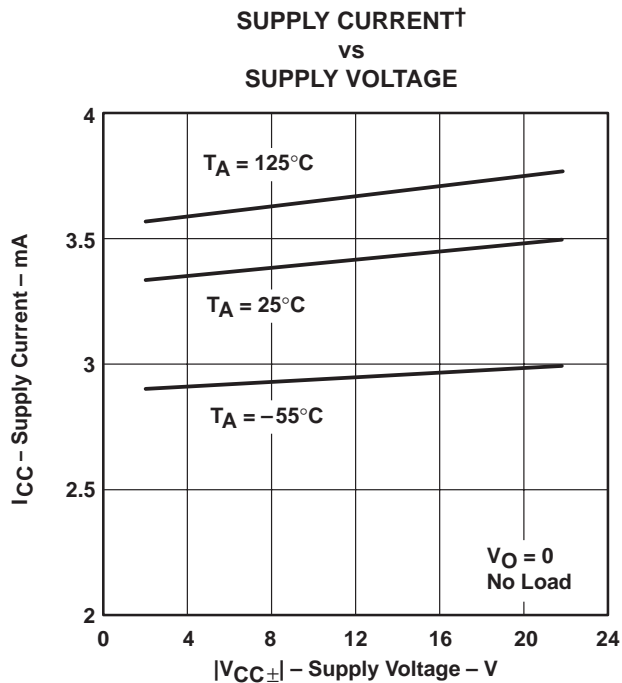

Figure 23

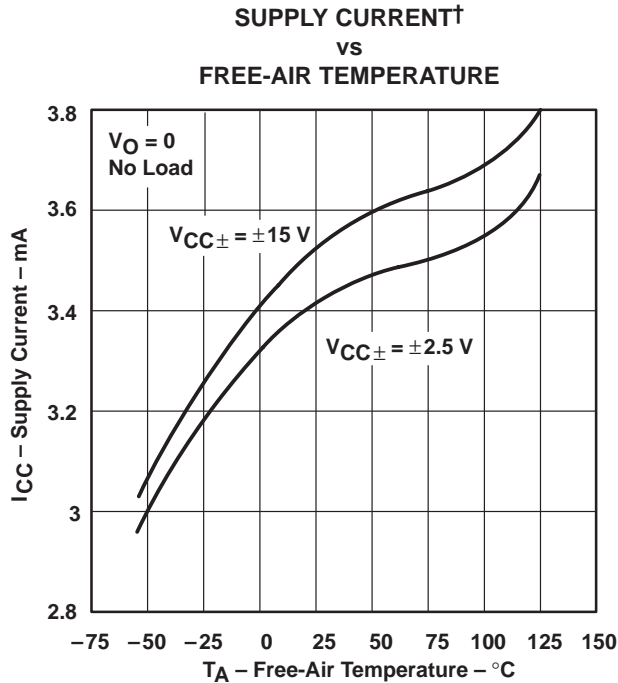

Figure 24

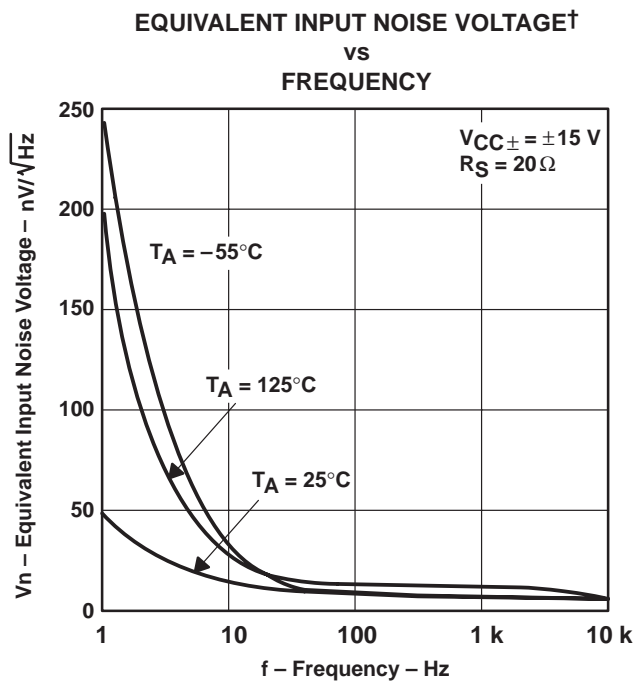

Figure 25

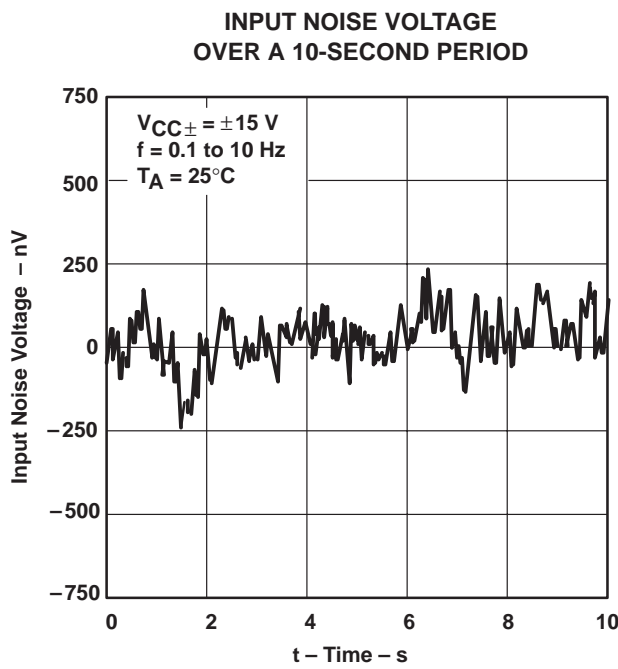

Figure 26

† Data at high and low temperatures are applicable only within the rated operating free-air temperature ranges of the various devices.

TLE214x, TLE214xA, TLE214xY
 EXCALIBUR LOW-NOISE HIGH-SPEED
 PRECISION OPERATIONAL AMPLIFIERS

SLOS183A – FEBRUARY 1997 – REVISED MARCH 1998

TYPICAL CHARACTERISTICS

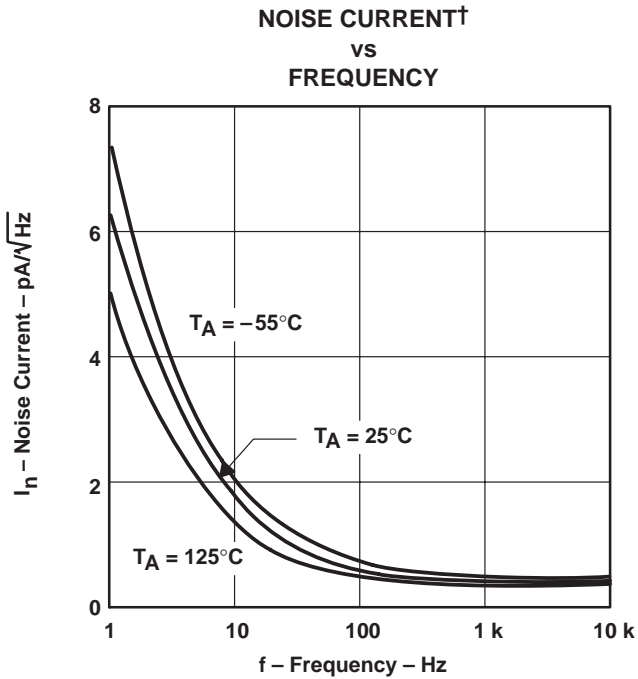

Figure 27

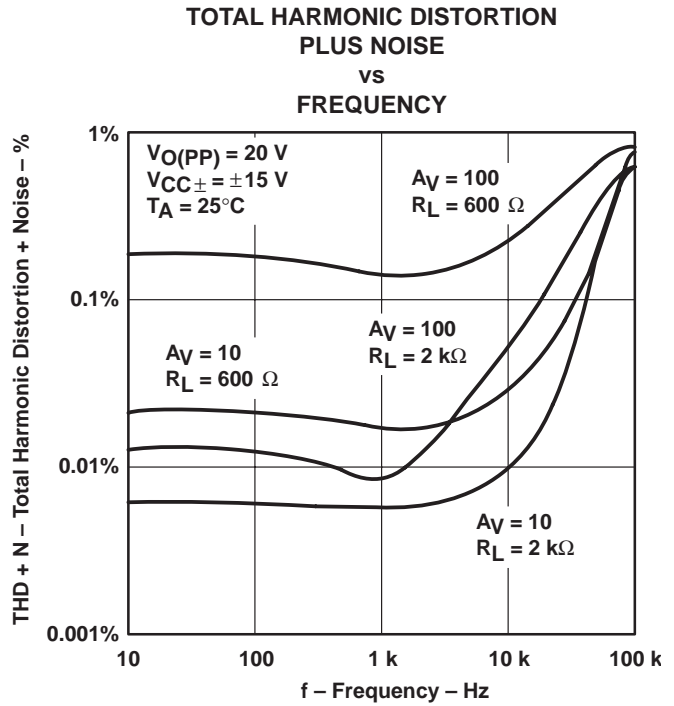

Figure 28

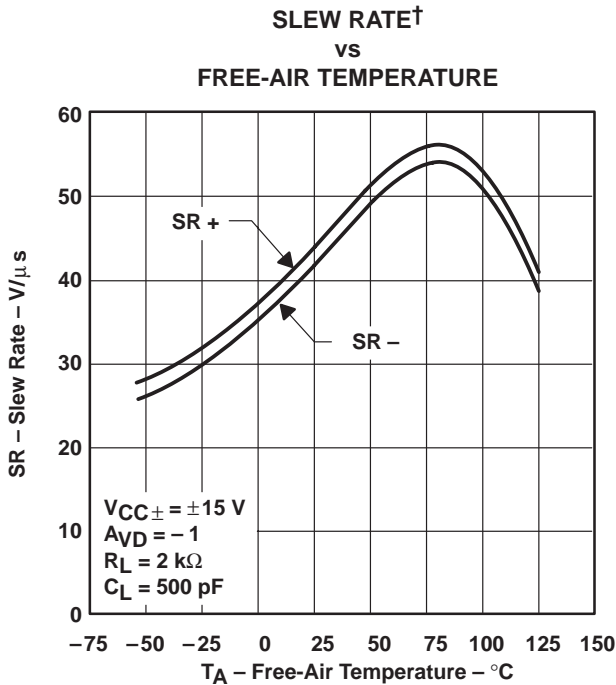

Figure 29

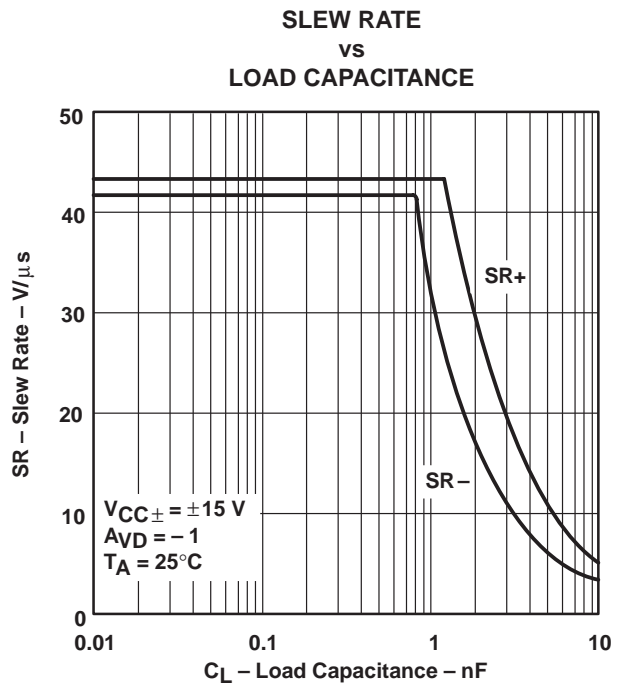

Figure 30

† Data at high and low temperatures are applicable only within the rated operating free-air temperature ranges of the various devices.



TYPICAL CHARACTERISTICS

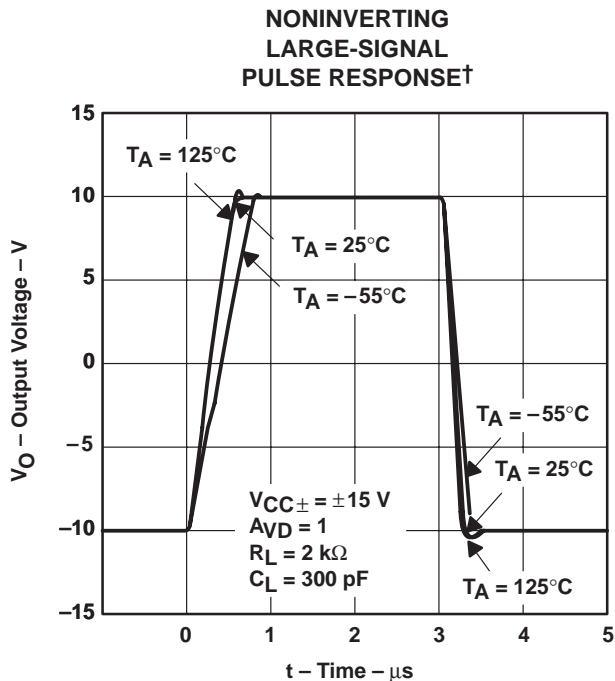

Figure 31

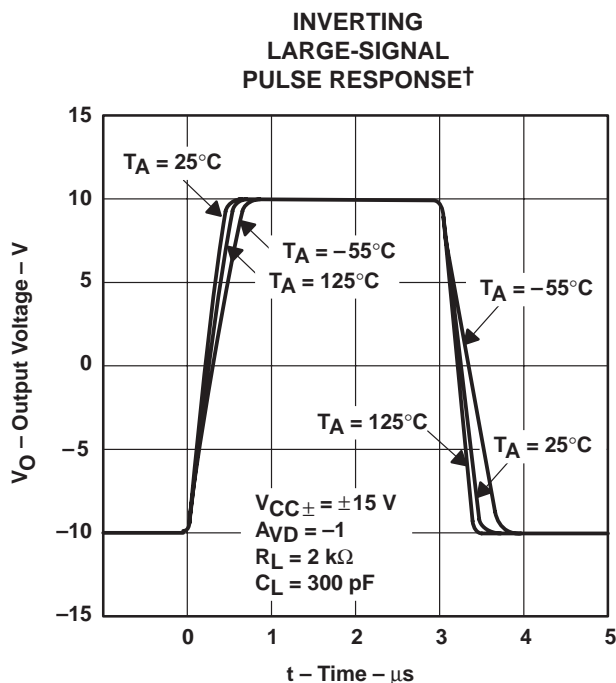

Figure 32

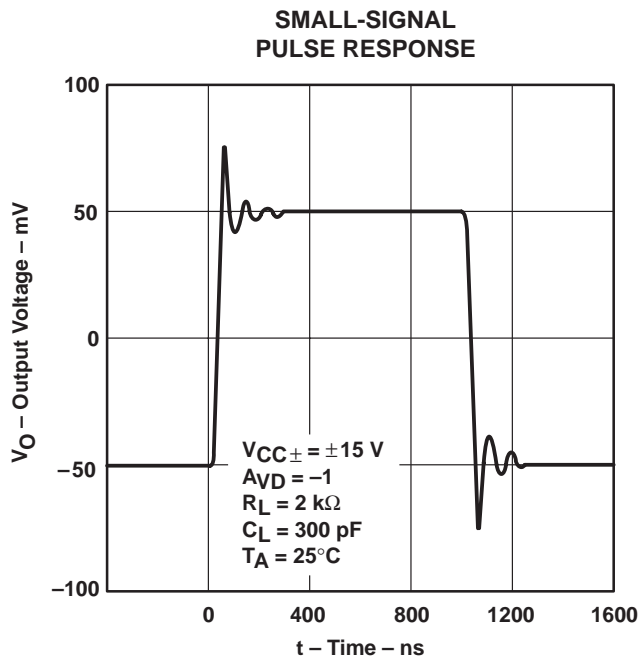

Figure 33

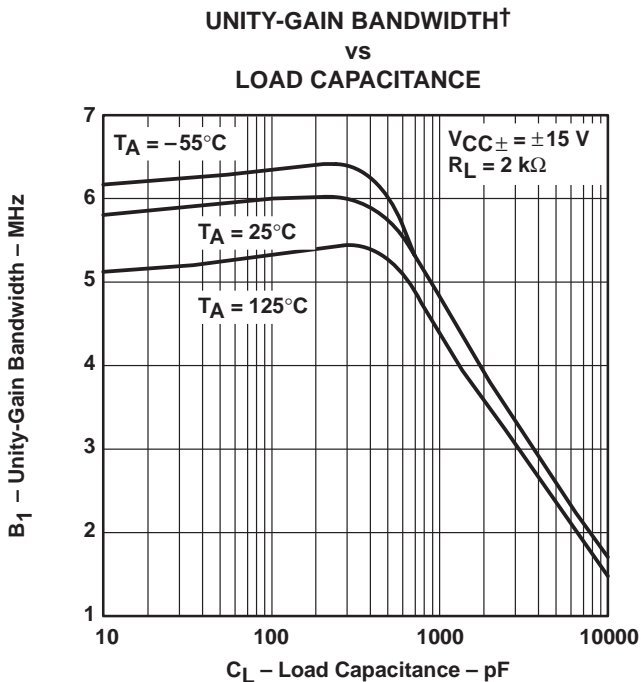
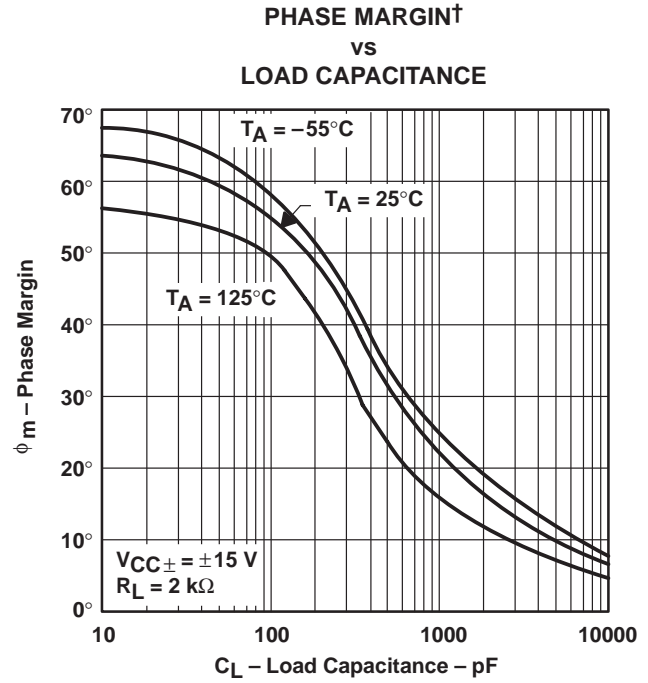
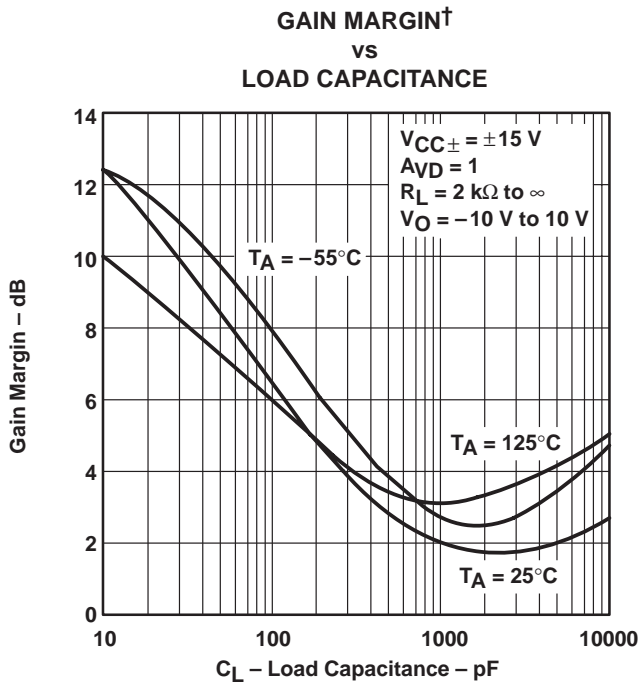

Figure 34

† Data at high and low temperatures are applicable only within the rated operating free-air temperature ranges of the various devices.

TYPICAL CHARACTERISTICS



† Data at high and low temperatures are applicable only within the rated operating free-air temperature ranges of the various devices.

APPLICATION INFORMATION

input offset voltage nulling

The TLE2141 series offers external null pins that can be used to further reduce the input offset voltage. If this feature is desired, connect the circuit of Figure 37 as shown. If external nulling is not needed, the null pins may be left unconnected.

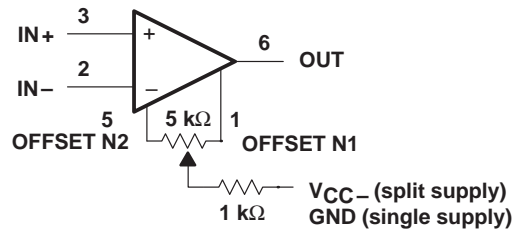

Figure 37. Input Offset Voltage Null Circuit

TLE214x, TLE214xA, TLE214xY
EXCALIBUR LOW-NOISE HIGH-SPEED
PRECISION OPERATIONAL AMPLIFIERS

SLOS183A – FEBRUARY 1997 – REVISED MARCH 1998

MECHANICAL INFORMATION

D (R-PDSO-G)**

PLASTIC SMALL-OUTLINE PACKAGE

14 PIN SHOWN

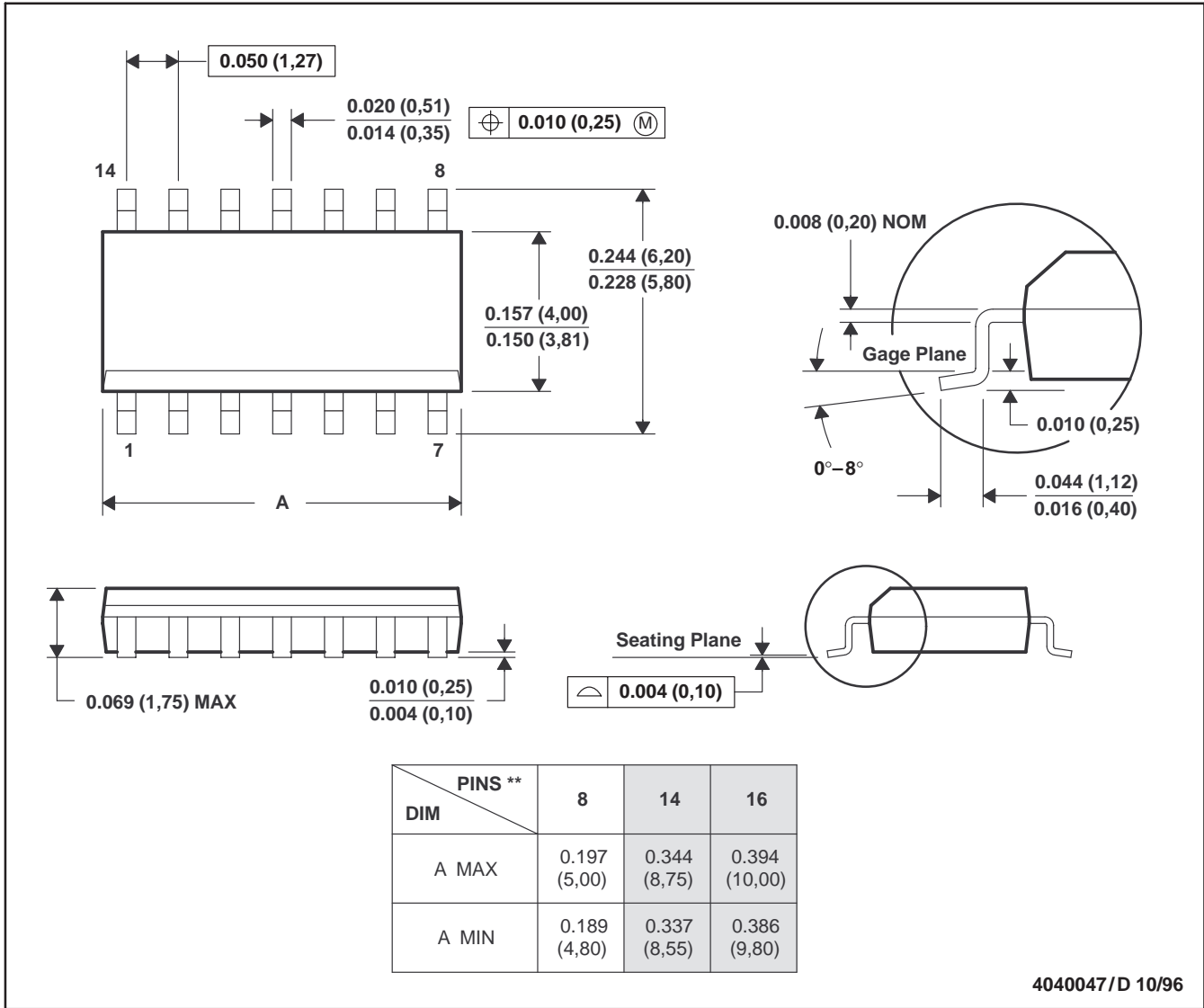

- NOTES: A. All linear dimensions are in inches (millimeters).
 B. This drawing is subject to change without notice.
 C. Body dimensions do not include mold flash or protrusion, not to exceed 0.006 (0,15).
 D. Falls within JEDEC MS-012

TLE214x, TLE214xA, TLE214xY
 EXCALIBUR LOW-NOISE HIGH-SPEED
 PRECISION OPERATIONAL AMPLIFIERS

SLOS183A – FEBRUARY 1997 – REVISED MARCH 1998

MECHANICAL INFORMATION

DW (R-PDSO-G**)

PLASTIC SMALL-OUTLINE PACKAGE

16 PIN SHOWN

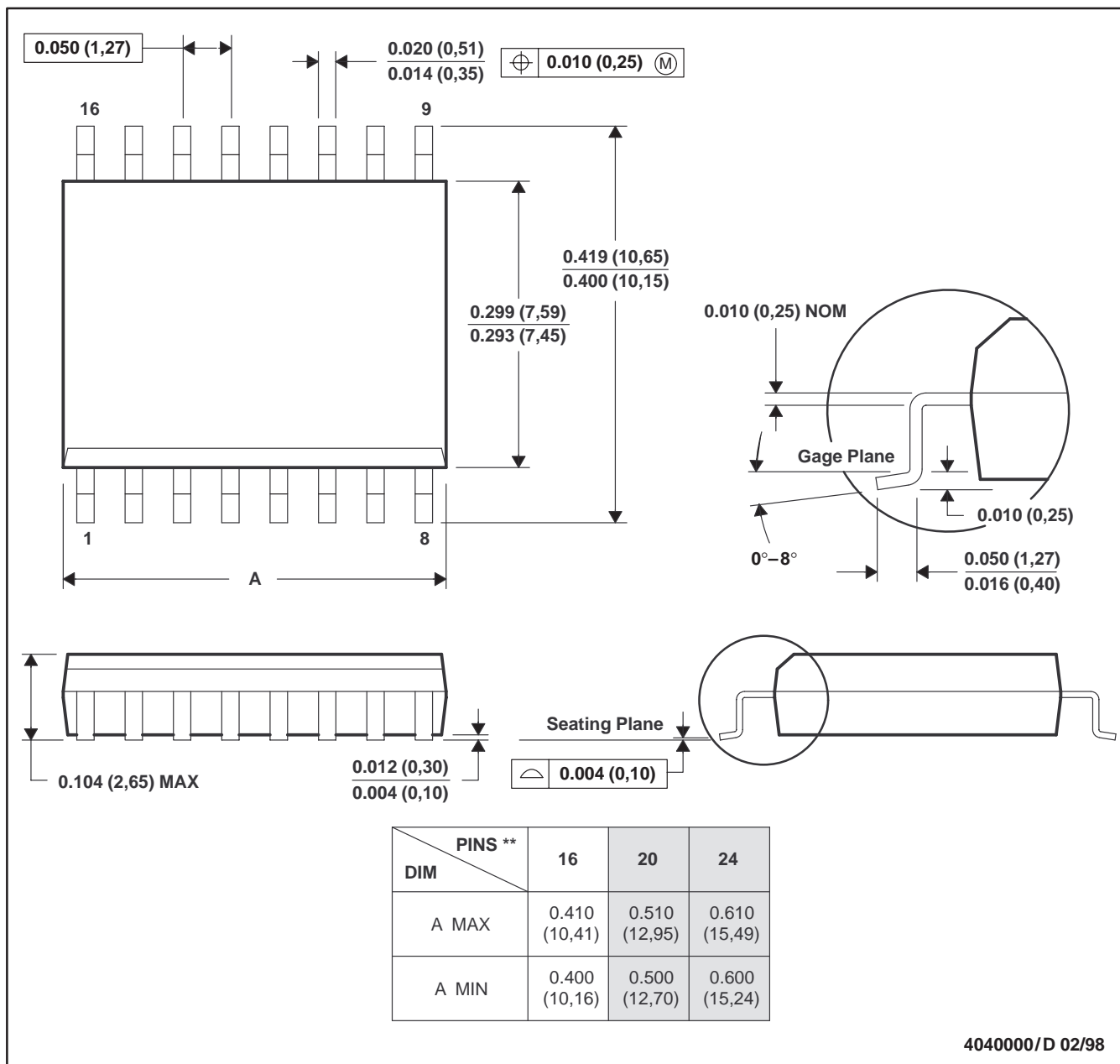

- NOTES: A. All linear dimensions are in inches (millimeters).
 B. This drawing is subject to change without notice.
 C. Body dimensions do not include mold flash or protrusion not to exceed 0.006 (0,15).
 D. Falls within JEDEC MS-013

TLE214x, TLE214xA, TLE214xY
EXCALIBUR LOW-NOISE HIGH-SPEED
PRECISION OPERATIONAL AMPLIFIERS

SLOS183A – FEBRUARY 1997 – REVISED MARCH 1998

MECHANICAL INFORMATION

FK (S-CQCC-N)**

LEADLESS CERAMIC CHIP CARRIER

28 TERMINAL SHOWN

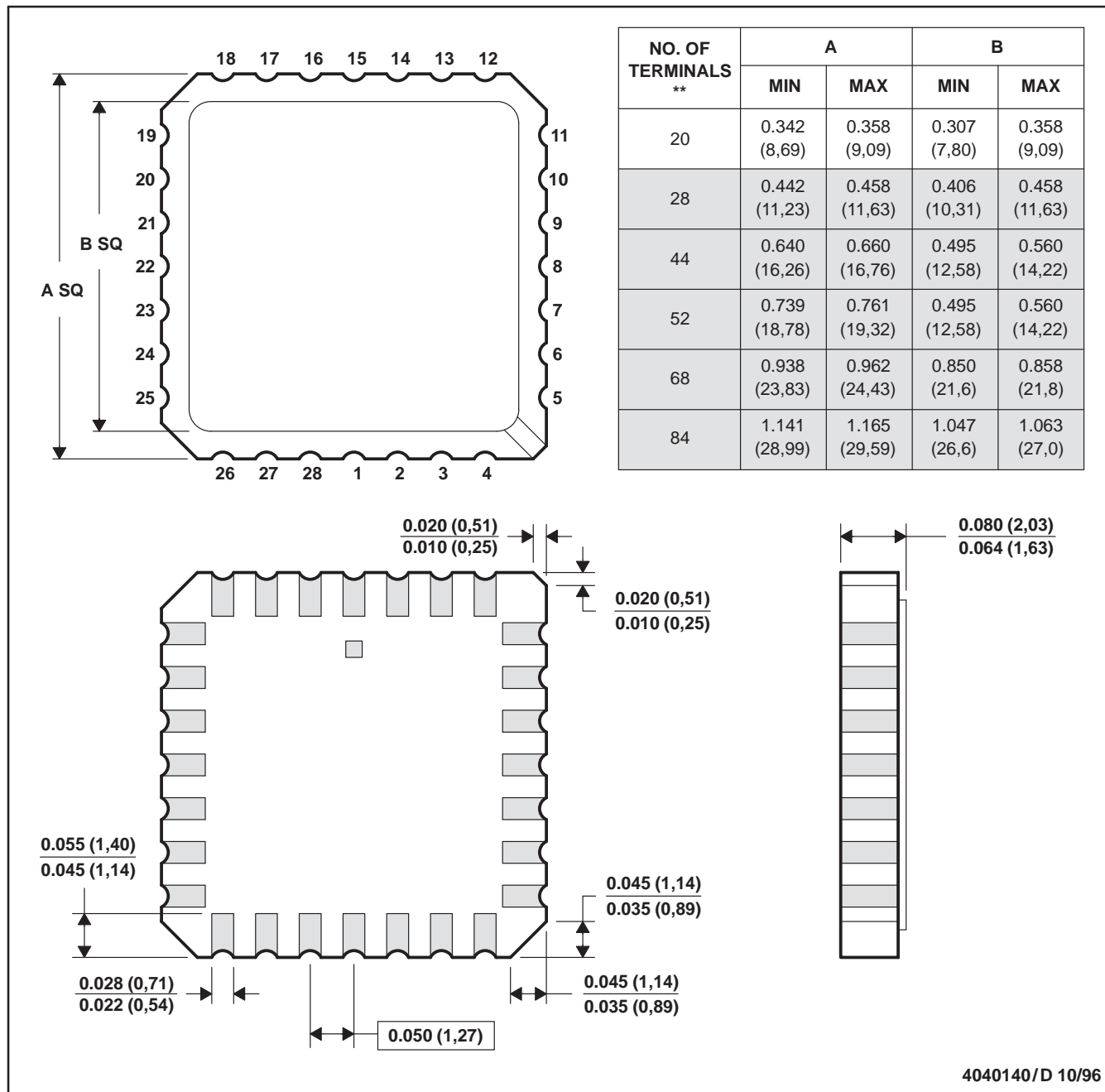

4040140/D 10/96

- NOTES: A. All linear dimensions are in inches (millimeters).
 B. This drawing is subject to change without notice.
 C. This package can be hermetically sealed with a metal lid.
 D. The terminals are gold plated.
 E. Falls within JEDEC MS-004



TLE214x, TLE214xA, TLE214xY
EXCALIBUR LOW-NOISE HIGH-SPEED
PRECISION OPERATIONAL AMPLIFIERS

SLOS183A – FEBRUARY 1997 – REVISED MARCH 1998

MECHANICAL INFORMATION

J (R-GDIP-T**)

CERAMIC DUAL-IN-LINE PACKAGE

14 PIN SHOWN

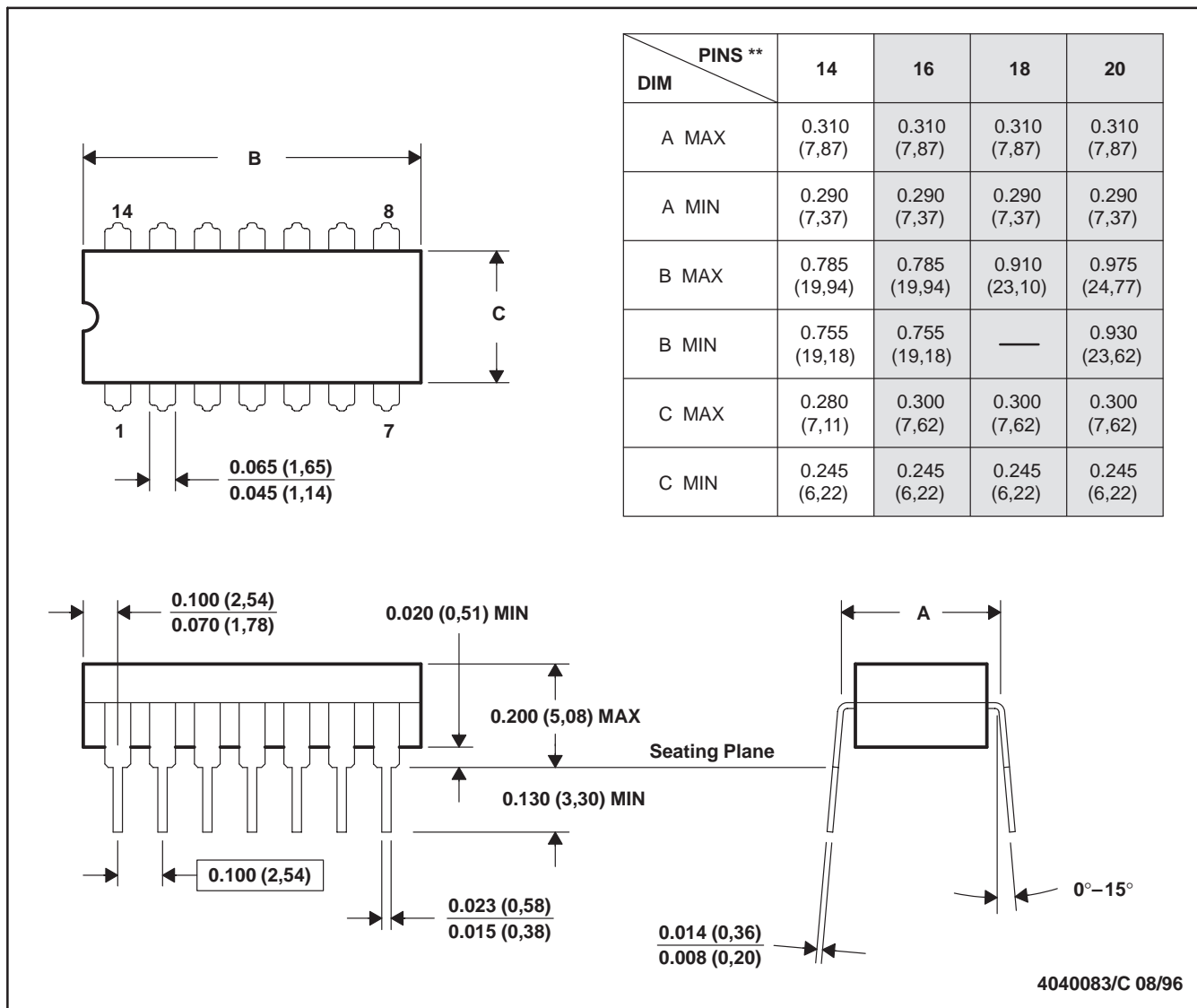

- NOTES: A. All linear dimensions are in inches (millimeters).
 B. This drawing is subject to change without notice.
 C. This package can be hermetically sealed with a ceramic lid using glass frit.
 D. Index point is provided on cap for terminal identification only on press ceramic glass frit seal only.
 E. Falls within MIL-STD-1835 GDIP1-T14, GDIP1-T16, GDIP1-T18, and GDIP1-T20

TLE214x, TLE214xA, TLE214xY
EXCALIBUR LOW-NOISE HIGH-SPEED
PRECISION OPERATIONAL AMPLIFIERS

SLOS183A – FEBRUARY 1997 – REVISED MARCH 1998

MECHANICAL INFORMATION

JG (R-GDIP-T8)

CERAMIC DUAL-IN-LINE PACKAGE

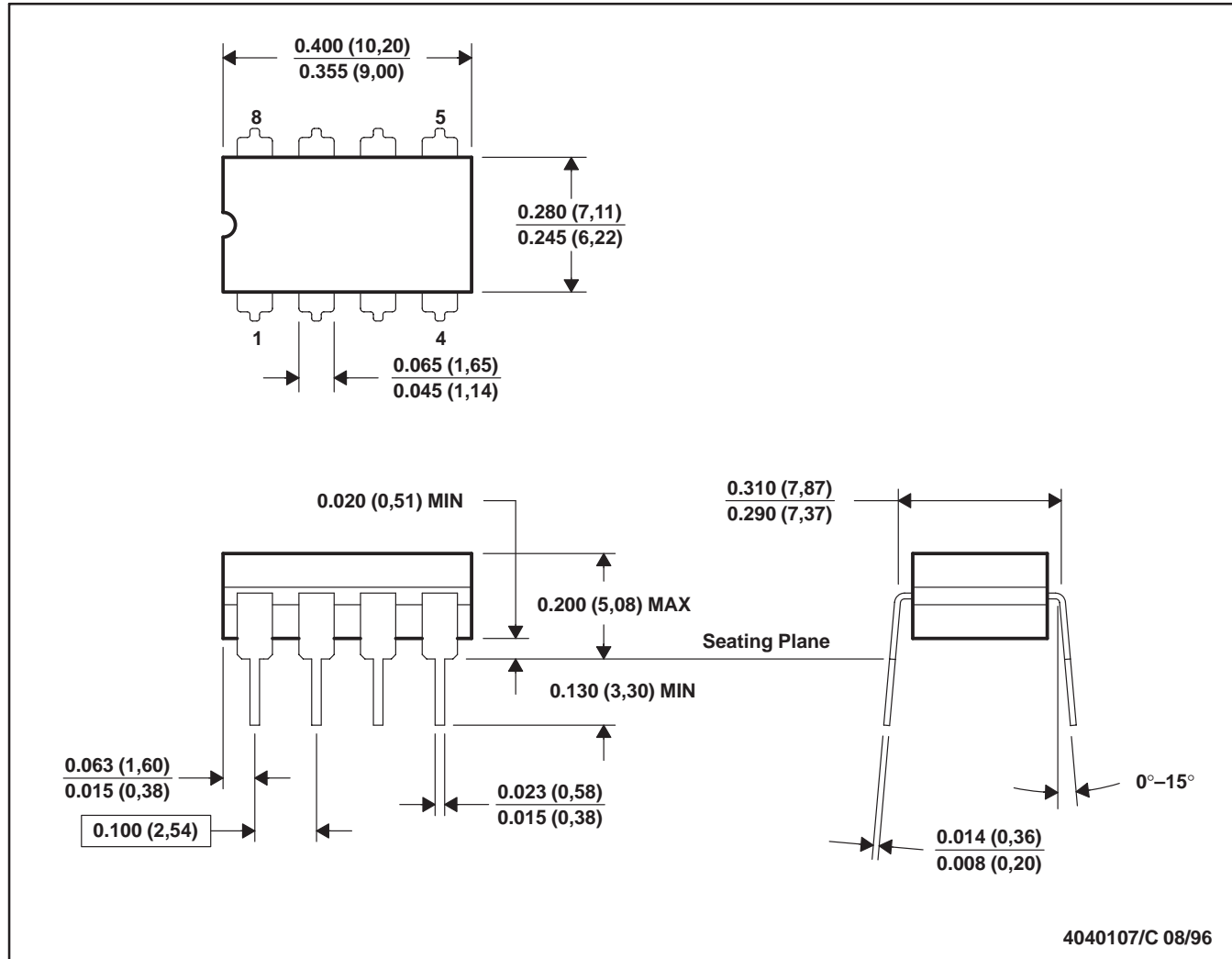

- NOTES: A. All linear dimensions are in inches (millimeters).
 B. This drawing is subject to change without notice.
 C. This package can be hermetically sealed with a ceramic lid using glass frit.
 D. Index point is provided on cap for terminal identification only on press ceramic glass frit seal only.
 E. Falls within MIL-STD-1835 GDIP1-T8



POST OFFICE BOX 655303 • DALLAS, TEXAS 75265

TLE214x, TLE214xA, TLE214xY
EXCALIBUR LOW-NOISE HIGH-SPEED
PRECISION OPERATIONAL AMPLIFIERS

SLOS183A – FEBRUARY 1997 – REVISED MARCH 1998

MECHANICAL INFORMATION

N (R-PDIP-T**)

PLASTIC DUAL-IN-LINE PACKAGE

16 PIN SHOWN

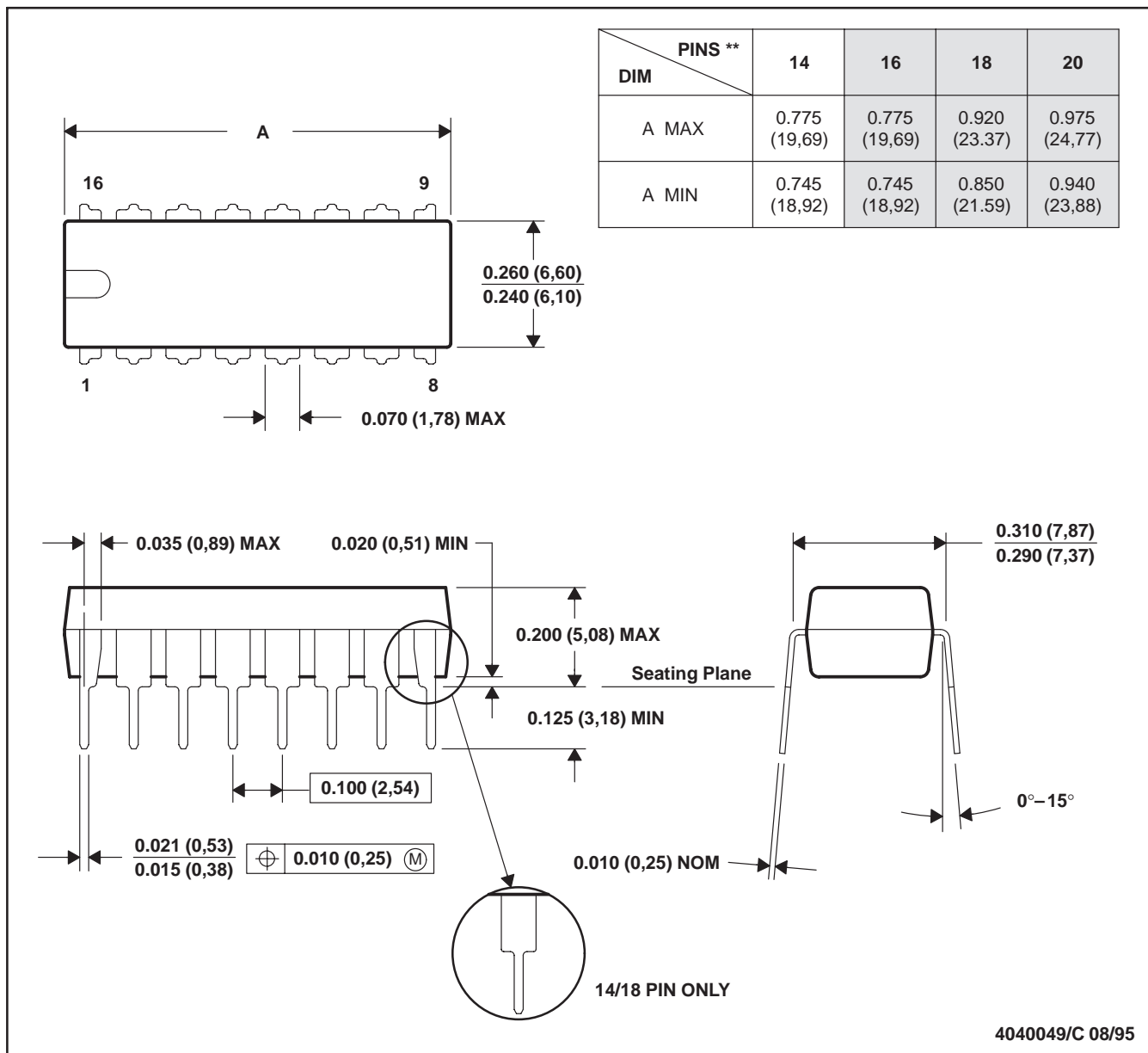

- NOTES: A. All linear dimensions are in inches (millimeters).
B. This drawing is subject to change without notice.
C. Falls within JEDEC MS-001 (20 pin package is shorter than MS-001.)

TLE214x, TLE214xA, TLE214xY
EXCALIBUR LOW-NOISE HIGH-SPEED
PRECISION OPERATIONAL AMPLIFIERS

SLOS183A – FEBRUARY 1997 – REVISED MARCH 1998

MECHANICAL INFORMATION

P (R-PDIP-T8)

PLASTIC DUAL-IN-LINE PACKAGE

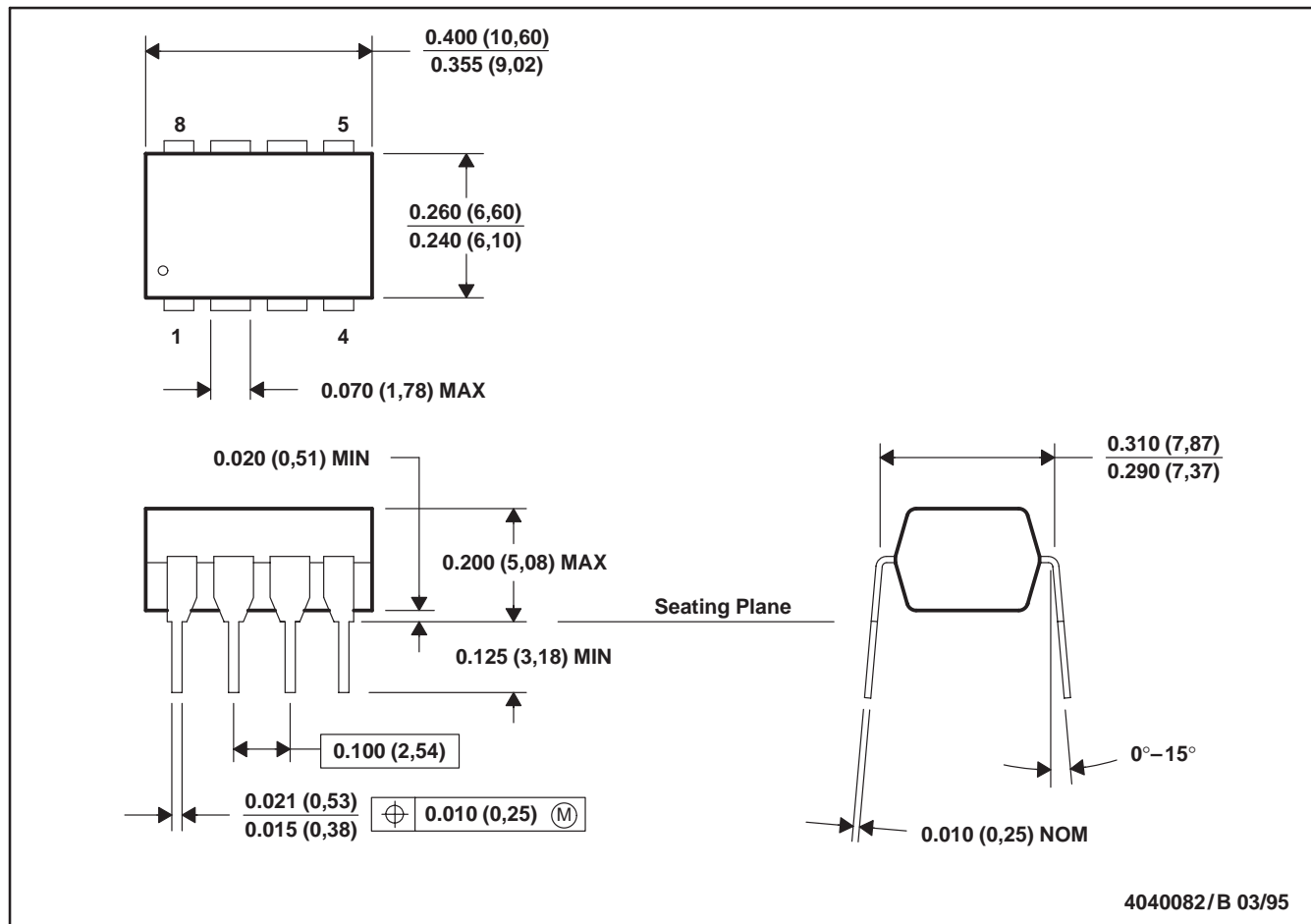

- NOTES: A. All linear dimensions are in inches (millimeters).
 B. This drawing is subject to change without notice.
 C. Falls within JEDEC MS-001

TLE214x, TLE214xA, TLE214xY
EXCALIBUR LOW-NOISE HIGH-SPEED
PRECISION OPERATIONAL AMPLIFIERS

SLOS183A – FEBRUARY 1997 – REVISED MARCH 1998

MECHANICAL INFORMATION

PW (R-PDSO-G**)

PLASTIC SMALL-OUTLINE PACKAGE

14 PIN SHOWN

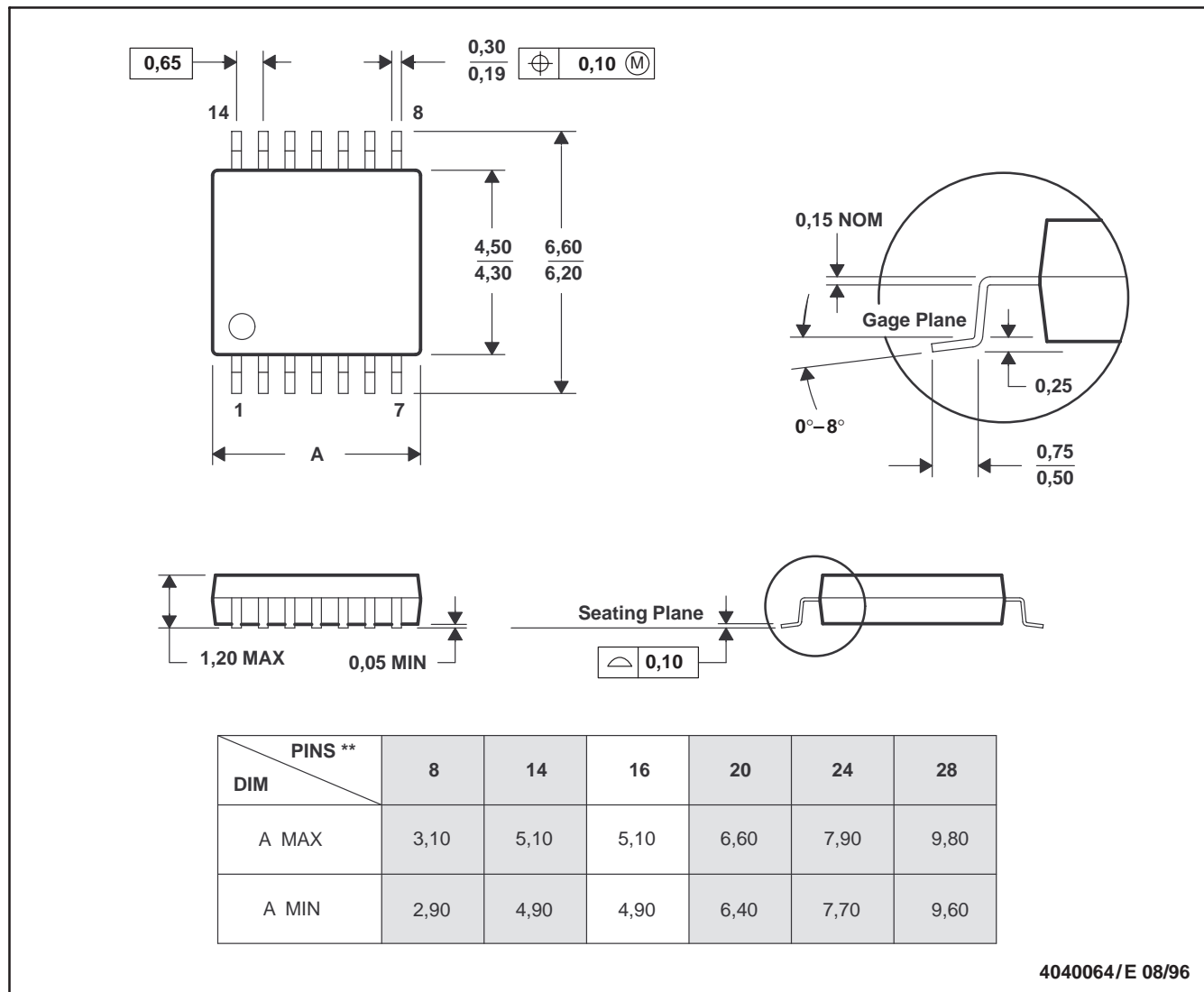

4040064/E 08/96

- NOTES: A. All linear dimensions are in millimeters.
 B. This drawing is subject to change without notice.
 C. Body dimensions do not include mold flash or protrusion not to exceed 0,15.
 D. Falls within JEDEC MO-153

IMPORTANT NOTICE

Texas Instruments and its subsidiaries (TI) reserve the right to make changes to their products or to discontinue any product or service without notice, and advise customers to obtain the latest version of relevant information to verify, before placing orders, that information being relied on is current and complete. All products are sold subject to the terms and conditions of sale supplied at the time of order acknowledgement, including those pertaining to warranty, patent infringement, and limitation of liability.

TI warrants performance of its semiconductor products to the specifications applicable at the time of sale in accordance with TI's standard warranty. Testing and other quality control techniques are utilized to the extent TI deems necessary to support this warranty. Specific testing of all parameters of each device is not necessarily performed, except those mandated by government requirements.

CERTAIN APPLICATIONS USING SEMICONDUCTOR PRODUCTS MAY INVOLVE POTENTIAL RISKS OF DEATH, PERSONAL INJURY, OR SEVERE PROPERTY OR ENVIRONMENTAL DAMAGE ("CRITICAL APPLICATIONS"). TI SEMICONDUCTOR PRODUCTS ARE NOT DESIGNED, AUTHORIZED, OR WARRANTED TO BE SUITABLE FOR USE IN LIFE-SUPPORT DEVICES OR SYSTEMS OR OTHER CRITICAL APPLICATIONS. INCLUSION OF TI PRODUCTS IN SUCH APPLICATIONS IS UNDERSTOOD TO BE FULLY AT THE CUSTOMER'S RISK.

In order to minimize risks associated with the customer's applications, adequate design and operating safeguards must be provided by the customer to minimize inherent or procedural hazards.

TI assumes no liability for applications assistance or customer product design. TI does not warrant or represent that any license, either express or implied, is granted under any patent right, copyright, mask work right, or other intellectual property right of TI covering or relating to any combination, machine, or process in which such semiconductor products or services might be or are used. TI's publication of information regarding any third party's products or services does not constitute TI's approval, warranty or endorsement thereof.