

REDRESSEMENT - FILTRAGE

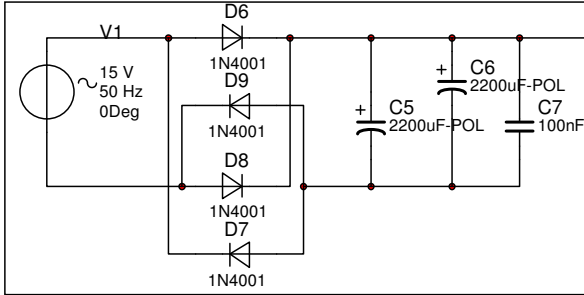

DISJONCTEUR ELECTRONIQUE

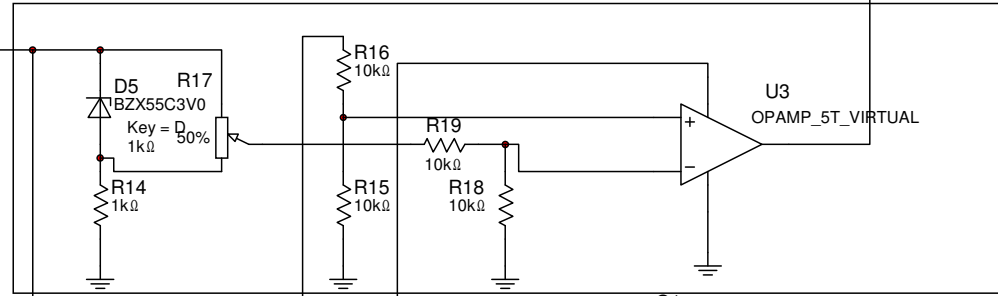

XSC2

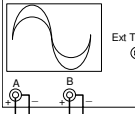

COMMANDE TENSION

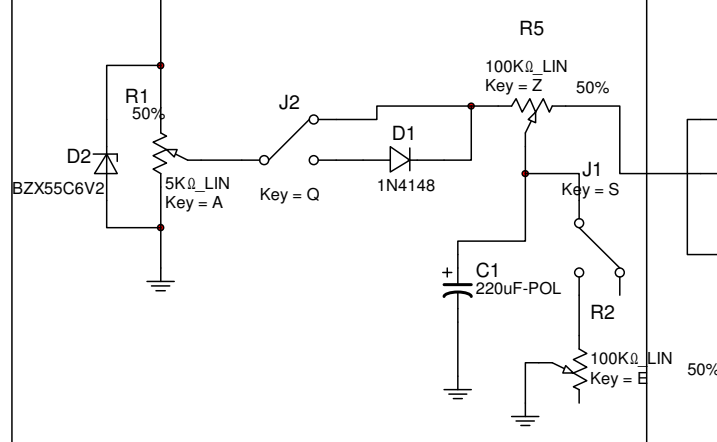

MOTEUR

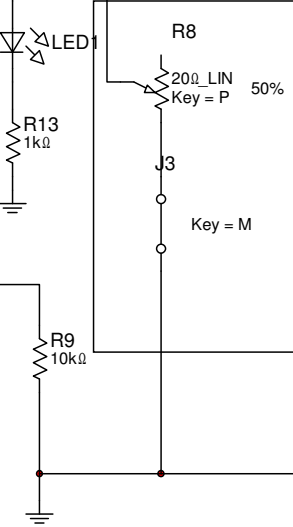

R10  
3.3kΩ

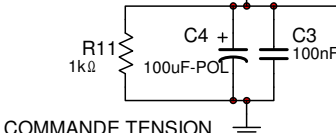

U1  
OPAMP\_5T\_VIRTUAL



U3  
OPAMP\_5T\_VIRTUAL

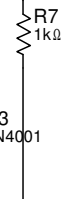

R8  
20Ω LIN  
Key = P  
50%

J3  
Key = M



R8  
20Ω LIN  
Key = P  
50%

J3  
Key = M



R8  
20Ω LIN  
Key = P  
50%

J3  
Key = M



R8  
20Ω LIN  
Key = P  
50%

J3  
Key = M

