

power light source

# LUXEON® K2

## Introduction

LUXEON® K2 is the most robust and powerful LED available. With unprecedented thermal, drive current and light output capabilities, it offers the lighting industry leading lumens per package and the opportunity to create never before possible lighting solutions. LUXEON K2 is available in all colors including cool-white, neutral-white, warm-white, blue, royal blue, green, cyan, red-orange, red and amber.

- ♦ deliver more useable light
- ♦ optimize applications to reduce size and cost
- ♦ engineer more robust applications
- ♦ reduce thermal management engineering
- ♦ utilize standard FR4 PCB technology in addition to MCPCB solutions
- ♦ simplify manufacturing through the use of surface mount technology.

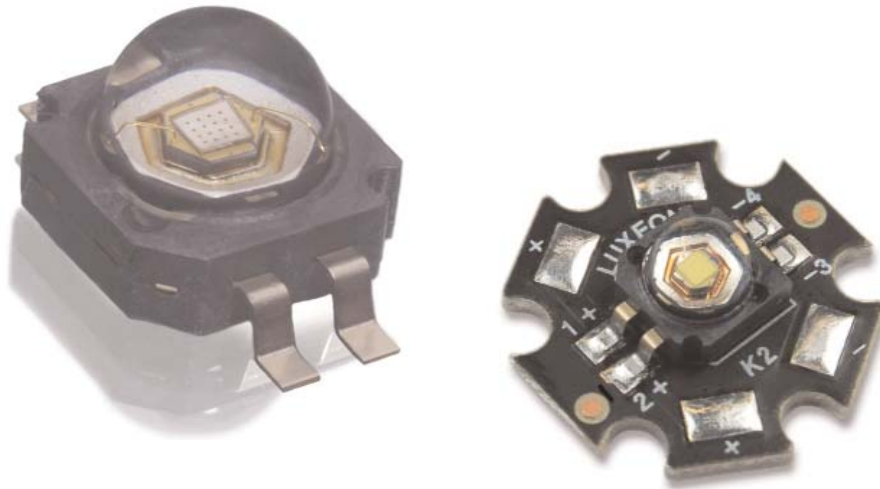

## LUXEON K2 Technology Leadership

- ♦ Highest operating junction temperature available, 185°C
- ♦ Industry leading lumen performance, > 140—175 lumens in 6500K white
- ♦ Highest Drive Currents—1500 mA
- ♦ Lowest Thermal Resistance—9°C/W
- ♦ Industry Best Moisture Sensitivity level—JEDEC 2a  
4 week floor life without reconditioning
- ♦ Lead free reflow solder  
JEDEC 020c compatible
- ♦ RoHS Compliant
- ♦ Autoclave compliant—  
JESD22 A-102
- ♦ Industry Best Lumen Maintenance—50,000 hours life at 1000 mA with 70% lumen maintenance

---

## Table of Contents

Product Nomenclature	.3
Average Lumen Maintenance Characteristics	.3
Environmental Compliance	.4
Flux Characteristics for LUXEON K2	.5
Flux Characteristics for LUXEON K2 Star	.6
Flux Performance, Binning, and Supportability	.7
Optical Characteristics	.8
Electrical Characteristics	.9
Absolute Maximum Ratings	.12
JEDEC Moisture Sensitivity	.13
Reflow Soldering Characteristics	.13
Mechanical Dimensions—SMT 4-Lead Gullwing Form	.14
Solder Pad Layout—SMT Lead Form	.15
Mechanical Dimensions—2-Lead Gullwing Form	.16
Solder Pad Design—2-Lead Gullwing	.17
Solder Pad Layout—2-Lead Gullwing	.17
Pin Out Diagram—Gullwing Form	.17
Mechanical Dimensions—LUXEON K2 Star	.18
Wavelength Characteristics	.19
Typical Light Output Characteristics Over Temperature	.21
Typical Forward Current Characteristics	.24
Typical Relative Luminous Flux	.25
Current Derating Curves	.27
Typical Radiation Patterns	.31
Emitter Reel Packaging	.34
White Binning Information	.35
LUXEON K2 Cool-White Bin Structure	.36
LUXEON K2 Neutral-White Bin Structure	.38
LUXEON K2 Warm-White Bin Structure	.40

---

## Product Nomenclature

The LUXEON K2 is available in two configurations, one tested and binned at 350 mA and a second tested and binned at 1000 mA. Due to production distribution and variance it is difficult to accurately correlate product performance across a broad drive current range. This is one of the reasons Philips Lumileds has elected to offer multiple test current options of the LUXEON K2 to better service our customers.

The part number designation is explained as follows:

L X K 2 - A B C D - E F G for LUXEON K2 Emitter

L 2 K 2 - A B C D - E F G H for LUXEON K2 Star

Where:

A — designates radiation pattern (value P for Lambertian)

B — designates color (see Philips Lumileds AB21)

C — designates color variant (1 for direct colors and Cool-White, N for Neutral-White, and W for Warm-White)

D — designates test current (value 2 for 350 mA, value 4 for 1000 mA)

E — designates minimum flux bin for LUXEON K2 Emitter (see Philips Lumileds AB21)

F — designates minimum flux bin for LUXEON K2 Star product (see Philips Lumileds AB21), Reserved for future product offerings in LUXEON K2 Emitter

G and H — Reserved for future product offerings.

Products tested and binned at 350 mA follow the part numbering scheme:

L X K 2 - x x x 2 - x x x (L2K2 - xxx2 - 11 - Bxxx for LUXEON K2 Star)

For these products typical performance is also listed for 700 mA operation.

Products tested and binned at 1000 mA follow the part numbering scheme:

L X K 2 - x x x 4 - x x x (L2K2 - xxx4 - 11 - Bxxx for LUNXEON K2 Star)

For these products typical performance is also listed for 1500 mA operation.

Both versions of this product are capable of operation over the entire drive current range, up to 1500 mA for cool-white, neutral white, warm-white, green, cyan, blue and royal blue and up to 700 mA for red, red-orange and amber.

In addition, multiple minimum performance levels of both products are available. Digit "E" (Digit "F" for K2 Star Product) in the part-numbering scheme above, specifying the minimum performance flux bin, designates the performance option.

## Average Lumen Maintenance Characteristics

Lifetime for solid-state lighting devices (LEDs) is typically defined in terms of lumen maintenance—the percentage of initial light output remaining after a specified period of time.

Philips Lumileds projects that white LUXEON K2 products will deliver, on average, 70% lumen maintenance at 50,000 hours of operation at a forward current of 1000 mA. This projection is based on constant current operation with junction temperature maintained at or below 120°C. Philips Lumileds projects that green, blue, cyan and royal blue LUXEON K2 products will deliver, on average, 70% lumen maintenance at 50,000 hours of operation at a forward current of 1000 mA. This projection is based on constant current operation with junction temperature maintained at or below 150°C. Philips Lumileds projects that red, red-orange and amber LUXEON K2 products will deliver, on average, 70% lumen maintenance at 50,000 hours of operation at a forward current of 350 mA. This projection is based on constant current operation with junction temperature maintained at or below 120°C.

This performance is based on independent test data, Philips Lumileds historical data from tests run on similar material systems, and internal LUXEON reliability testing. Observation of design limits included in this data sheet is required in order to achieve this projected lumen maintenance.

---

## Environmental Compliance

Philips Lumileds is committed to providing environmentally friendly products to the solid-state lighting market. The LUXEON K2 is compliant to the European Union directives on the Restriction of Hazardous Substances in electronic equipment, namely the RoHS directive. Philips Lumileds will not intentionally add the following restricted materials to the LUXEON K2: lead, mercury, cadmium, hexavalent chromium, polybrominated biphenyls (PBB) or polybrominated diphenyl ethers (PBDE).

## Flux Characteristics for LUXEON K2

### Junction Temperature, $T_J = 25^\circ\text{C}$

Table 1.

Performance at Test Currents					Typical Performance at Indicated Current	
Color	Part Number	Minimum Luminous Flux (lm) or Radiometric Power (mW) $\Phi_V^{[1] [3]}$	Typical Luminous Flux (lm) or Radiometric Power (mW) $\Phi_V^{[2] [3]}$	Test Current (mA)	Typical Luminous Flux (lm) or Radiometric Power (mW) $\Phi_V^{[2] [3]}$	Drive Current (mA)
Cool-White	LXK2-PW12-R00 <sup>[5]</sup>	39.8	45	350	75	700
	LXK2-PW12-S00	51.7	60	350	100	700
	LXK2-PW14-T00 <sup>[5]</sup>	80	85	1000	110	1500
	LXK2-PW14-U00 <sup>[5]</sup>	87.4	100	1000	130	1500
	LXK2-PW14-V00	113.6	120	1000	140	1500
Neutral-White	LXK2-PWN2-Q00 <sup>[5]</sup>	30.6	35	350	60	700
	LXK2-PWN2-R00 <sup>[5]</sup>	39.8	45	350	75	700
	LXK2-PWN2-S00	51.7	60	350	100	700
	LXK2-PWN4-T00 <sup>[5]</sup>	67.2	80	1000	105	1500
	LXK2-PWN4-U00 <sup>[5]</sup>	87.4	100	1000	130	1500
LXK2-PWN4-V00	113.6	120	1000	140	1500	
Warm-White	LXK2-PWW2-Q00 <sup>[5]</sup>	30.6	35	350	60	700
	LXK2-PWW2-R00	39.8	45	350	75	700
	LXK2-PWW4-T00 <sup>[5]</sup>	67.2	80	1000	105	1500
	LXK2-PWW4-U00	87.4	100	1000	130	1500
Green	LXK2-PM12-R00 <sup>[5]</sup>	39.8	45	350	75	700
	LXK2-PM12-S00 <sup>[5]</sup>	51.7	60	350	100	700
	LXK2-PM14-U00 <sup>[5]</sup>	87.4	100	1000	130	1500
Cyan	LXK2-PE12-Q00 <sup>[5]</sup>	30.6	35	350	60	700
	LXK2-PE12-R00 <sup>[5]</sup>	39.8	45	350	75	700
	LXK2-PE12-S00	51.7	60	350	100	700
	LXK2-PE14-T00 <sup>[5]</sup>	67.2	80	1000	105	1500
	LXK2-PE14-U00 <sup>[5]</sup>	87.4	100	1000	130	1500
Blue	LXK2-PB12-K00 <sup>[5]</sup>	8.2	9.5	350	16	700
	LXK2-PB12-L00 <sup>[5]</sup>	10.7	12.5	350	21	700
	LXK2-PB12-M00	13.9	16	350	27	700
	LXK2-PB14-N00 <sup>[5]</sup>	18.1	21	1000	35	1500
	LXK2-PB14-P00 <sup>[5]</sup>	23.5	27	1000	35	1500
	LXK2-PB14-Q00	30.6	35	1000	46	1500
Royal Blue	LXK2-PR12-L00 <sup>[5]</sup>	175 mW	200 mW	350	330 mW	700
	LXK2-PR12-M00 <sup>[5]</sup>	225 mW	290 mW	350	480 mW	700
	LXK2-PR14-Q00 <sup>[5]</sup>	435 mW	475 mW	1000	620 mW	1500
	LXK2-PR14-R00 <sup>[5]</sup>	515 mW	575 mW	1000	750 mW	1500

Notes for Table 1 on next page.

## Flux Characteristics for LUXEON K2, Continued Junction Temperature, $T_J = 25^\circ\text{C}$

Table 1 Continued .

Performance at Test Currents					Typical Performance at Indicated Current	
Color	Part Number	Minimum Luminous Flux (lm) or Radiometric Power (mW) $\Phi_V^{[1][3]}$	Typical Luminous Flux (lm) or Radiometric Power (mW) $\Phi_V^{[2][3]}$	Test Current (mA)	Typical Luminous Flux (lm) or Radiometric Power (mW) $\Phi_V^{[2][3]}$	Drive Current (mA)
Red	LXK2-PD12-Q00 <sup>[5]</sup>	30.6	35	350	60	700
	LXK2-PD12-R00 <sup>[5]</sup>	39.8	45	350	75	700
	LXK2-PD12-S00	51.7	60	350	100	700
Red-Orange	LXK2-PH12-R00 <sup>[5]</sup>	39.8	45	350	75	700
	LXK2-PH12-S00 <sup>[5]</sup>	51.7	60	350	100	700
Amber	LXK2-PL12-P00 <sup>[5]</sup>	23.5	27	350	46	700
	LXK2-PL12-Q00 <sup>[5]</sup>	30.6	35	350	60	700
	LXK2-PL12-R00	39.8	45	350	75	700

## Flux Characteristics for LUXEON K2 Star, Junction Temperature, $T_J = 25^\circ\text{C}$

Table 2.

Performance at Test Currents					Typical Performance at Indicated Current	
Color	Flux Bin	Minimum Luminous Flux (lm) or Radiometric Power (mW) $\Phi_V^{[1][3]}$	Typical Luminous Flux (lm) or Radiometric Power (mW) $\Phi_V^{[2][3]}$	Test Current (mA)	Typical Luminous Flux (lm) or Radiometric Power (mW) $\Phi_V^{[2][3]}$	Drive Current (mA)
Cool-White	L2K2-MW12-11-BR00	39.8	45	350	75	700
	L2K2-MW12-11-BS00	51.7	60	350	100	700
	L2K2-MW14-11-BT00	80	85	1000	110	1500
	L2K2-MW14-11-BU00	87.4	100	1000	130	1500
	L2K2-MW14-11-BV00	113.6	120	1000	140	1500
Neutral-White	L2K2-MWN2-11-BQ00	30.6	35	350	60	700
	L2K2-MWN2-11-BR00	39.8	45	350	75	700
	L2K2-MWN2-11-BS00	51.7	60	350	100	700
	L2K2-MWN4-11-BT00	67.2	80	1000	105	1500
	L2K2-MWN4-11-BU00	87.4	100	1000	130	1500
Warm-White	L2K2-MWN4-11-BV00	113.6	120	1000	140	1500
	L2K2-MWW2-11-BQ00	30.6	35	350	60	700
	L2K2-MWW2-11-BR00	39.8	45	350	75	700
	L2K2-MWW4-11-BT00	67.2	80	1000	105	1500
	L2K2-MWW4-11-BU00	87.4	100	1000	130	1500

Notes for Table 1 and Table 2:

- Minimum luminous flux or radiometric power performance guaranteed within published operating conditions. Philips Lumileds maintains a tolerance of  $\pm 10\%$  on flux and power measurements.
- Typical luminous flux or radiometric power performance when device is operated within published operating conditions.
- LUXEON K2 products with even higher luminous flux and radiometric power levels will become available in the future. Please consult Philips Lumileds or Future Electronics for more information.
- Radiation Pattern for all LUXEON K2 Star products is Lambertian.
- Best supportability on these part numbers—design is recommended for high-volume applications.

---

## Flux Performance, Binning, and Supportability

LEDs are produced with semiconductor technology that is subject to process variation, yielding a range of flux performance that is approximately Gaussian in nature. In order to provide customers with fine granularity within the overall flux distribution, Philips Lumileds separates LEDs into fixed, easy to design with, minimum luminous flux bins. To verify supportability of parts chosen for your application design, please consult your Philips Lumileds/Future Lighting Solutions sales representative.

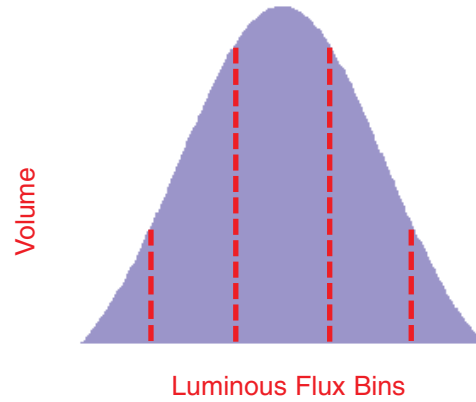

## Optical Characteristics

### LUXEON K2 at Test Current<sup>[1]</sup> Junction Temperature, $T_J = 25^\circ\text{C}$

Table 3.

Color	Dominant Wavelength <sup>[2]</sup> $\lambda_D$ , Peak Wavelength <sup>[3]</sup> $\lambda_P$ , or Color Temperature <sup>[4]</sup> CCT			Typical Spectral Half-width <sup>[6]</sup> (nm) $\Delta\lambda_{1/2}$	Typical Temperature Coefficient of Dominant Wavelength (nm/°C) $\Delta\lambda_D / \Delta T_J$	Typical Total Included Angle <sup>[7]</sup> (degrees) $\theta_{0.90V}$	Typical Viewing Angle <sup>[8]</sup> (degrees) $2\theta_{1/2}$
	Min.	Typ.	Max.				
Cool White	4500 K	6500 K	10000 K	-	-	160	140
Neutral White	3500K	4100K	4500K	-	-	160	140
Warm White	2650K	3000K	3500K	-	-	160	140
Green	520 nm	530 nm	550 nm	35	0.04	160	140
Cyan	490 nm	505 nm	520 nm	30	0.04	160	140
Blue	460 nm	470 nm	490 nm	25	0.04	160	140
Royal Blue <sup>[9]</sup>	440 nm	455 nm	460 nm	20	0.04	160	140
Red	620.5 nm	627 nm	645 nm	20	0.05	160	140
Red-Orange	613.5 nm	617 nm	620.5 nm	20	0.06	160	140
Amber	584.5 nm	590 nm	597 nm	14	0.09	160	140

Notes for Table 3:

1. Test current is 350 mA for all LXX2 - xxx2 - xxx (L2K2 - xxx2 - 11 - xxxx for K2 Star) products, and 1000 mA for all LXX2 - xxx4 - xxx products (L2K2 - xxx4 - 11 - xxxx for K2 Star).
2. Dominant wavelength is derived from the CIE 1931 Chromaticity diagram and represents the perceived color. Philips Lumileds maintains a tolerance of  $\pm 0.5$  nm for dominant wavelength measurements.
3. Royal blue product is binned by radiometric power and peak wavelength rather than photometric lumens and dominant wavelength. Philips Lumileds maintains a tolerance of  $\pm 2$ nm for peak wavelength measurements.
4. CCT  $\pm 5\%$  tester tolerance
5. Typical CRI (Color Rendering Index) for Cool-White product is 70, Neutral-White is 75, and Warm-White is 80.
6. Spectral width at  $1/2$  of the peak intensity.
7. Total angle at which 90% of total luminous flux is captured.
8. Viewing angle is the off axis angle from lamp centerline where the luminous intensity is  $1/2$  of the peak value.
9. All white, green, cyan, blue and royal blue products are built with Indium Gallium Nitride (InGaN).
10. All red, red-orange and amber products are built with Aluminum Indium Gallium Phosphide (AlInGaP).
11. Blue and royal blue power light sources represented here are IEC825 class 2 for eye safety.



## Electrical Characteristics

### Electrical Characteristics at 350mA Part Numbers L XK2-xxx2-xxx, Junction Temperature, $T_J = 25^{\circ}\text{C}$

Table 4.

Color	Forward Voltage $V_f$ <sup>[1]</sup>			Typical Temperature Coefficient of Forward Voltage <sup>[2]</sup> (mV/ $^{\circ}\text{C}$ ) $\Delta V_F / \Delta T_J$	Typical Thermal Resistance Junction to Case ( $^{\circ}\text{C}/\text{W}$ ) $R\theta_{J-C}$
	Min.	Typ. (V)	Max.		
Cool-White <sup>[1]</sup>	2.79	3.42	4.23	-2.0 to -4.0	9 (13 for Star)
Neutral-White <sup>[1]</sup>	2.79	3.42	4.23	-2.0 to -4.0	9 (13 for Star)
Warm-White <sup>[1]</sup>	2.79	3.42	4.23	-2.0 to -4.0	9 (13 for Star)
Green <sup>[1]</sup>	2.79	3.42	4.23	-2.0 to -4.0	9
Cyan <sup>[1]</sup>	2.79	3.42	4.23	-2.0 to -4.0	9
Blue <sup>[1]</sup>	2.79	3.42	4.23	-2.0 to -4.0	9
Royal Blue <sup>[1]</sup>	2.79	3.42	4.23	-2.0 to -4.0	9
Red	2.31	2.95	3.51	-2.0 to -4.0	12
Red-Orange	2.31	2.95	3.51	-2.0 to -4.0	12
Amber	2.31	2.95	3.51	-2.0 to -4.0	-2.0 to -4.0

Notes for Table 4:

1. Philips Lumileds maintains a tolerance of  $\pm 0.06\text{V}$  on forward voltage measurements.
2. Measured between  $25^{\circ}\text{C} = T_J = 110^{\circ}\text{C}$  at  $I_f = 350\text{ mA}$ .
3. The forward voltage of the LUXEON K2 LED will reduce by up to  $0.30\text{V}$  at  $350\text{mA}$  during the first few hours of operation after SMT reflow. Due to this effect, Philips Lumileds recommends current source drive for consistent and reliable performance. Cross connected series/parallel arrays or voltage drivers which could result in current hogging or variation in drive current are not recommended. Please consult your Philips Lumileds authorized distributor or Philips Lumileds Sales Representative for further information.

\*Dynamic resistance is the inverse of the slope in linear forward voltage model for LEDs. See figures 14 and 15.

## Typical Electrical Characteristics at 700mA Part Numbers L XK2-xxx2-xxx, Junction Temperature, $T_J = 25^\circ\text{C}$

Table 5.

Color	Typical Forward Voltage $V_f$ [1] (V)
Cool-White	3.60
Neutral-White	3.60
Warm-White	3.60
Green	3.60
Cyan	3.60
Blue	3.60
Royal Blue	3.60
Red	3.60
Red-Orange	3.60
Amber	3.60

Notes for Table 5:

1. Philips Lumileds maintains a tolerance of  $\pm 0.06\text{V}$  on forward voltage measurements.
2. Dynamic resistance is the inverse of the slope in linear forward voltage model for LEDs. See figures 14 and 15.
3. Measured between  $25^\circ\text{C} = T_J = 110^\circ\text{C}$  at  $I_f = 700\text{ mA}$ .

## Electrical Characteristics at 1000mA Part Numbers L XK2-xxx4-xxx, Junction Temperature, $T_J = 25^\circ\text{C}$

Table 6.

Color	Forward Voltage $V_f$ <sup>[1]</sup> (V)			Typical Dynamic Resistance <sup>[2]</sup> ( $\Omega$ ) $R_D$	Typical Temperature Coefficient of Forward Voltage <sup>[3]</sup> (mV/ $^\circ\text{C}$ ) $\Delta V_f / \Delta T_J$	Typical Thermal Resistance Junction to Case ( $^\circ\text{C}/\text{W}$ ) $R\theta_{J-C}$
	Min.	Typ.	Max.			
Cool-White <sup>[4]</sup>	3.03	3.72	4.95	0.6	-2.0	9 (13 for Star)
Neutral-White <sup>[4]</sup>	3.03	3.72	4.95	0.6	-2.0	9 (13 for Star)
Warm-White <sup>[4]</sup>	3.03	3.72	4.95	0.6	-2.0	9 (13 for Star)
Green <sup>[4]</sup>	3.03	3.72	4.95	0.6	-2.0	9
Cyan <sup>[4]</sup>	3.03	3.72	4.95	0.6	-2.0	9
Blue <sup>[4]</sup>	3.03	3.72	4.95	0.6	-2.0	9
Royal Blue <sup>[4]</sup>	3.03	3.72	4.95	0.6	-2.0	9

Notes for Table 6:

1. Philips Lumileds maintains a tolerance of  $\pm 0.06\text{V}$  on forward voltage measurements
2. Dynamic resistance is the inverse of the slope in linear forward voltage model for LEDs. See figure 14.
3. Measured between  $25^\circ\text{C} = T_J = 110^\circ\text{C}$  at  $I_f = 1000\text{ mA}$ .
4. The forward voltage of the LUXEON K2 LED will reduce by up to 0.50V at 1000mA during the first few hours of operation after SMT reflow. Due to this effect, Philips Lumileds recommends current source drive for consistent and reliable performance. Cross connected series/parallel arrays or voltage drivers which could result in current hogging or variation in drive current are not recommended. Please consult your Philips Lumileds authorized distributor or Philips Lumileds Sales Representative for further information.

## Typical Electrical Characteristics at 1500mA Part Numbers L XK2-xxx4-xxx, Junction Temperature, $T_J = 25^\circ\text{C}$

Table 7.

Color	Typical Forward Voltage $V_f$ <sup>[1]</sup> (V)
Cool-White	3.85
Neutral-White	3.85
Warm-White	3.85
Green	3.85
Cyan	3.85
Blue	3.85
Royal Blue	3.85

Notes for Table 7:

1. Philips Lumileds maintains a tolerance of  $\pm 0.06\text{V}$  on forward voltage measurements.

## Absolute Maximum Ratings

Table 8.

Parameter	Cool-White/Neutral-White/ Warm-White Value	Green/Cyan Blue/Royal Blue Value	Red/Red-Orange /Amber Value
DC Forward Current (mA)	1500	1500	700
Peak Pulsed Forward Current (mA)	1500	1500	700
Average Forward Current (mA)	1500	1500	700
ESD Sensitivity	2,000 V HBM Class 2 JESD22-A114-B	2,000 V HBM Class 2 JESD22-A114-B	2,000 V HBM Class 2 JESD22-A114-B
LED Junction Temperature	150°C	185°C	150°C
Max Case Temperature	135°C	170°C	135°C
Storage Temperature	-40°C - 185°C	-40°C - 185°C	-40°C - 185°C
K2 Star Aluminum-Core PCB Temperature	105°C	N/A	N/A
Soldering Temperature	JEDEC 020c 260°C	JEDEC 020c 260°C	JEDEC 020c 260°C
Allowable Reflow Cycles	3	3	3
Autoclave Conditions	121°C at 2 ATM, 100% RH for 72 hours max	121°C at 2 ATM, 100% RH for 72 hours max	121°C at 2 ATM, 100% RH for 72 hours max
Reverse Voltage (Vr)	See Note 2	See Note 2	See Note 2

Notes for Table 8:

1. Proper current derating must be observed to maintain junction temperature below the maximum.
2. LEDs are not designed to be driven in reverse bias.
3. Stresses in excess of the absolute maximum ratings can cause damage to the emitter. Maximum Rating limits apply to each parameter in isolation, all parameters having values within the Current Derating Curve. It should not be assumed that limiting values of more than one parameter can be applied to the product at the same time. Exposures to the absolute maximum ratings for extended periods can adversely affect device reliability. See Current Derating Curves in this document for more details.

## JEDEC Moisture Sensitivity

Table 9.

Level	Soak Requirements					
	Floor Life		Standard		Accelerated Environment	
	Time	Conditions	Time (hours)	Conditions	Time (hours)	Conditions
2a	4 weeks	$\leq 30^{\circ}\text{C}$ / 60% RH	696 <sup>(1)</sup> + 5/-0	$30^{\circ}\text{C}$ / 60% RH	120 +1/-0	$60^{\circ}\text{C}$ / 60% RH

Notes for Table 9:

- The standard soak time includes a default value of 24 hours for semiconductor manufacturer's exposure time (MET) between bake and bag and includes the maximum time allowed out of the bag at the distributor's facility.

## Reflow Soldering Characteristics

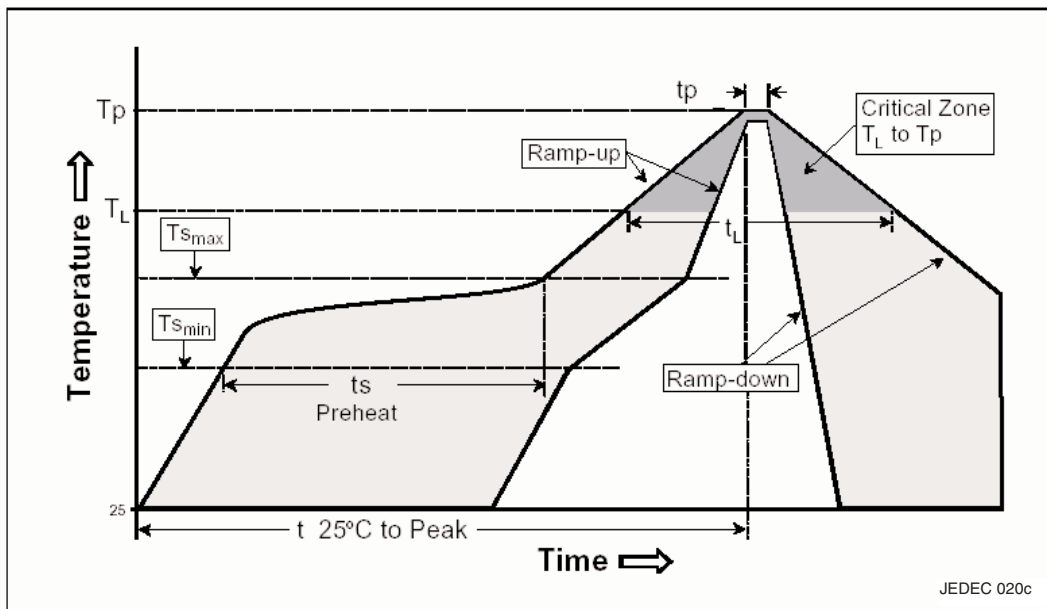

Table 10.

Profile Feature	Lead Free Assembly
Average Ramp-Up Rate ( $T_{s_{max}}$ to $T_p$ )	$3^{\circ}\text{C}$ / second max
Preheat Temperature Min ( $T_{s_{min}}$ )	$150^{\circ}\text{C}$
Preheat Temperature Max ( $T_{s_{max}}$ )	$200^{\circ}\text{C}$
Preheat Time ( $t_{s_{min}}$ to $t_{s_{max}}$ )	60 - 180 seconds
Temperature ( $T_l$ )	$217^{\circ}\text{C}$
Time Maintained Above Temperature ( $T_l$ )	60 - 150 seconds
Peak / Classification Temperature ( $T_p$ )	$260^{\circ}\text{C}$
Time Within $5^{\circ}\text{C}$ of Actual Peak Temperature ( $T_p$ )	20 - 40 seconds
Ramp - Down Rate	$6^{\circ}\text{C}$ / second max
Time $25^{\circ}\text{C}$ to Peak Temperature	8 minutes max

Notes for Table 10:

- All temperatures refer to topside of the package, measured on the package body surface.

## Mechanical Dimensions—SMT 4-Lead Gullwing Form

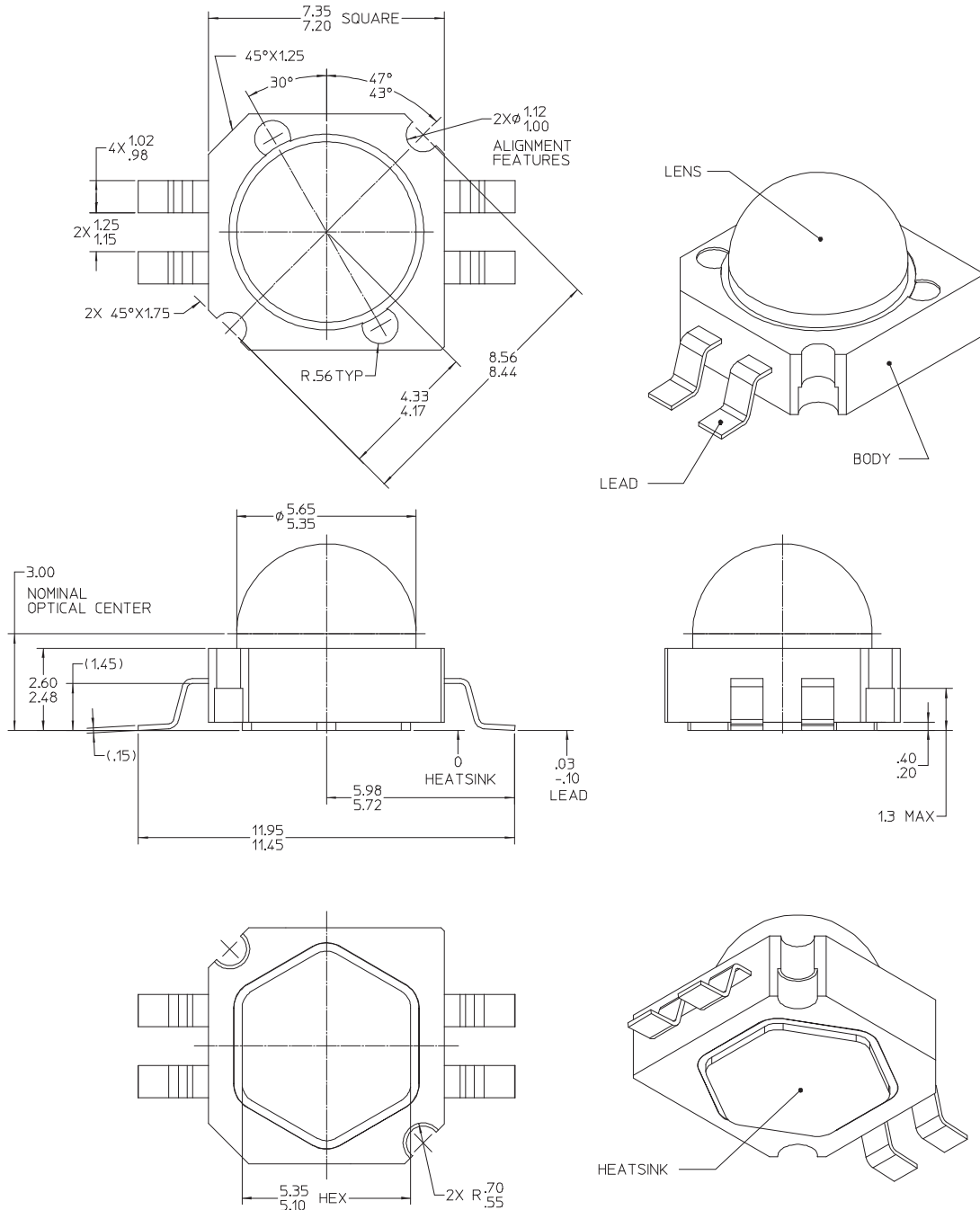

**Figure 1. 4-lead Gullwing Package Outline Drawing.**

Notes for Figure 1:

1. The anode side of the device is denoted by the chamfer on the part body. Electrical insulation between the case and the board is required—slug of the device is not electrically neutral. Do not electrically connect either the anode or cathode to the slug.
2. Do not handle the device by the lens except as described in Philips Lumileds document AB29.
3. Drawings not to scale.
4. All dimensions are in millimeters.
5. All dimensions without tolerances are for reference only.
6. Recommended solder paste thickness of 0.15mm.

## Solder Pad Design—SMT Lead Form

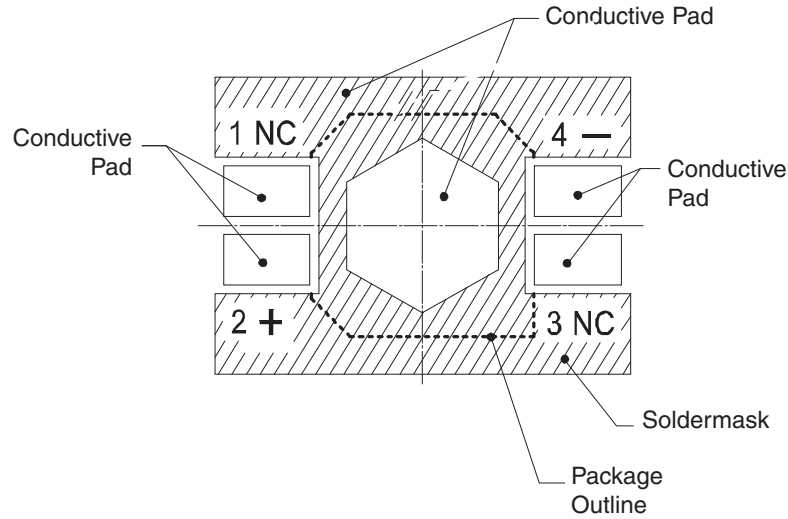

Figure 2. 4-Lead Gullwing Solder Pad Design.

Notes for Figure 2:

1. Electrical isolation is required between signal leads and hexagonal heat slug contact.
2. For optimal thermal performance, maximize board metallization at hexagonal heat slug contact.

## Solder Pad Layout—SMT Lead Form

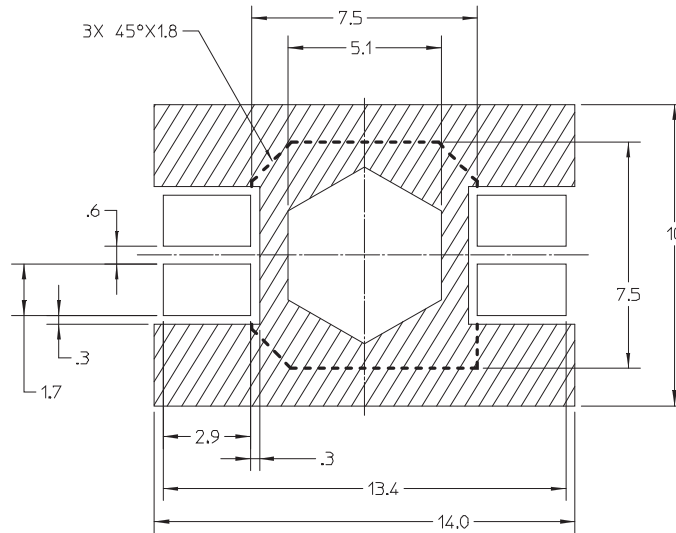

Figure 3. 4-Lead Gullwing Package Solder Pad Layout.

## Pin Out Diagram

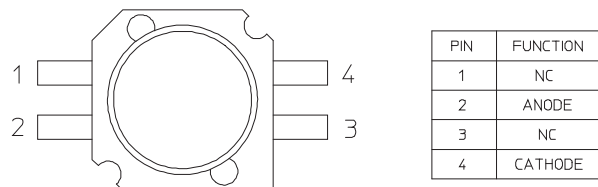
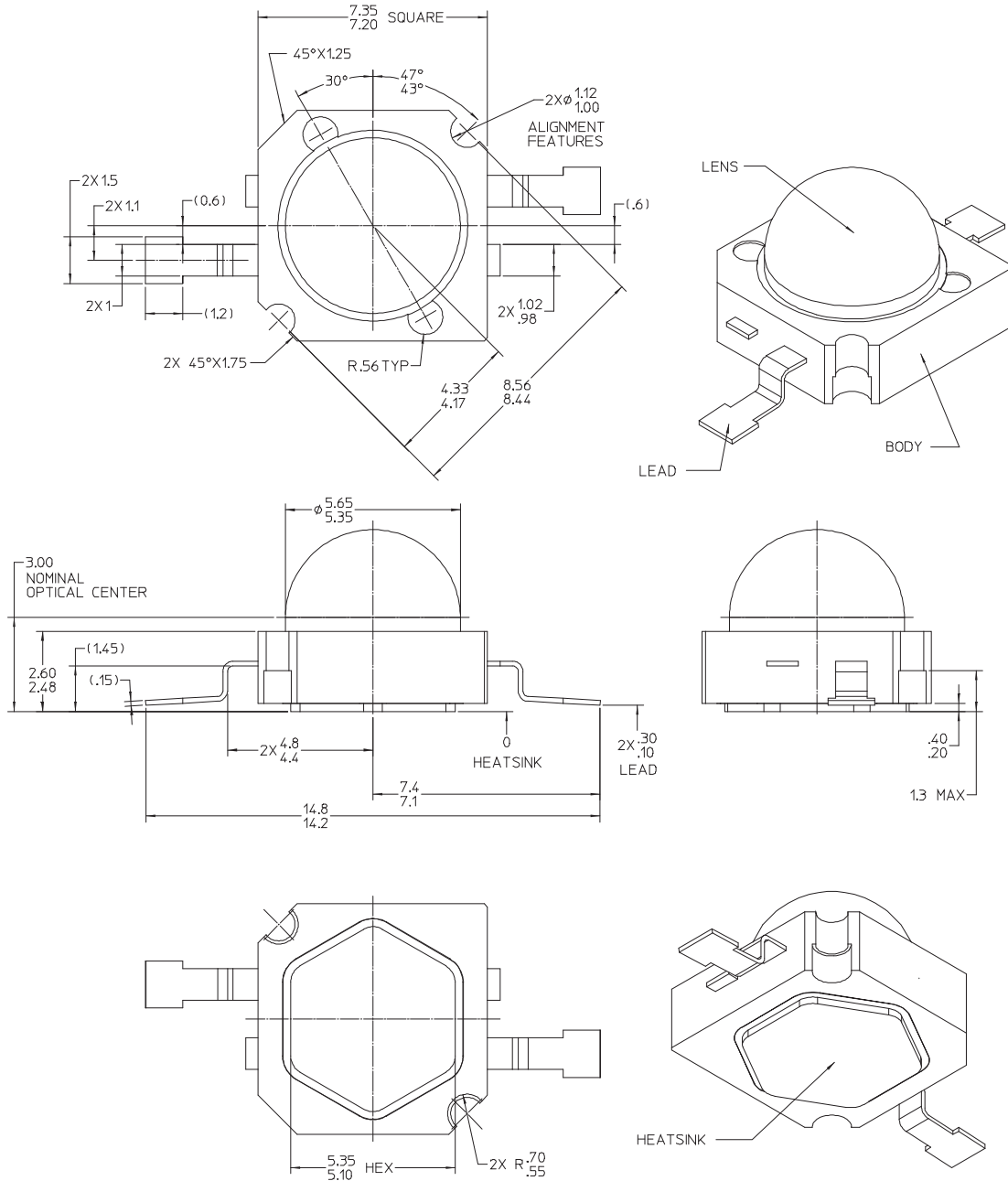

Figure 4. 4-Lead Gullwing Pin Out Diagram.

## Mechanical Dimensions—2-Lead Gullwing Form<sup>[8]</sup>



**Figure 5. 2-Lead Gullwing Package Outline Drawing.**

Notes for Figure 5:

1. The anode side of the device is denoted by the chamfer on the part body. Electrical insulation between the case and the board is required—slug of the device is not electrically neutral. Do not electrically connect either the anode or cathode to the slug.
2. Do not handle the device by the lens except as described in Philips Lumileds document AB29—care must be taken to avoid damage to the lens or the interior of the device that can be damaged by excessive force to the lens.
3. Drawings not to scale.
4. All dimensions are in millimeters.
5. All dimensions without tolerances are for reference only.
6. Recommended solder paste thickness of 0.15mm.
7. Available as a custom part number, contact your local Future Lumileds representative for more information.
8. The 2-Lead Gullwing part is not recommended for use in solder re-flow systems. Mount these parts with a thermal adhesive and hot bar soldering. For conventional reflow surface-mounting, use 4-Lead Gullwing Form.



## Solder Pad Design—2-Lead Gullwing

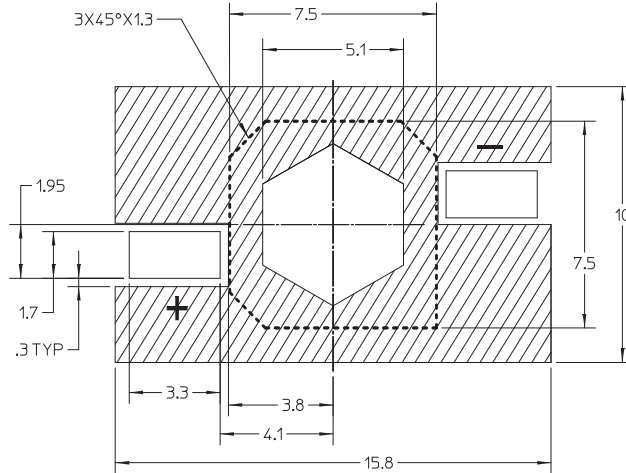

Figure 6. 2-Lead Gullwing Package Solder Pad Layout.

Notes for Figure 6:

1. Electrical isolation is required between signal leads and hexagonal heat slug contact.
2. For optimal thermal performance, maximize board metallization at hexagonal heat slug contact.

## Solder Pad Layout—2-Lead Gullwing

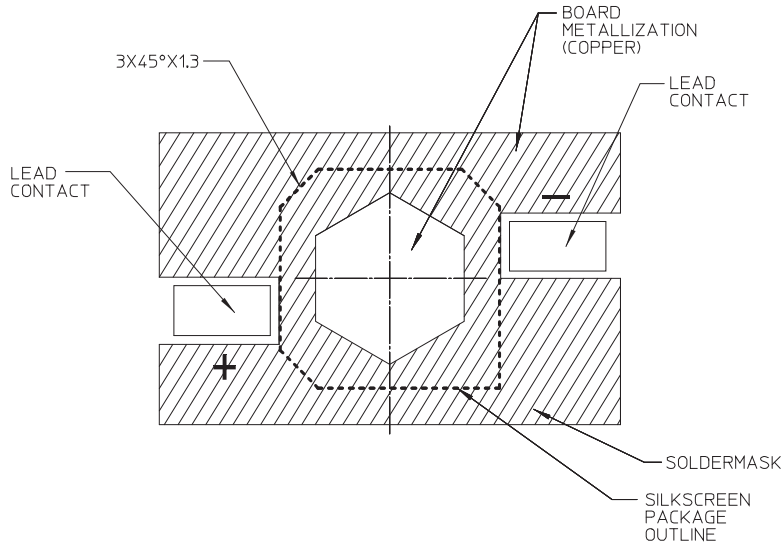
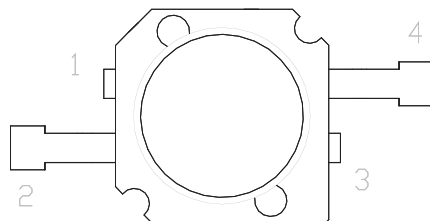

Figure 7. Solder Pad Layout 2-Lead Gullwing.

## Pin Out Diagram—Gullwing Form

PIN-OUT DETAIL



PIN	FUNCTION
1	NC (TRIMMED)
2	ANODE
3	NC (TRIMMED)
4	CATHODE

Figure 8. 2-Lead Gullwing Pin Out Diagram.

## Mechanical Dimensions—LUXEON K2 Star

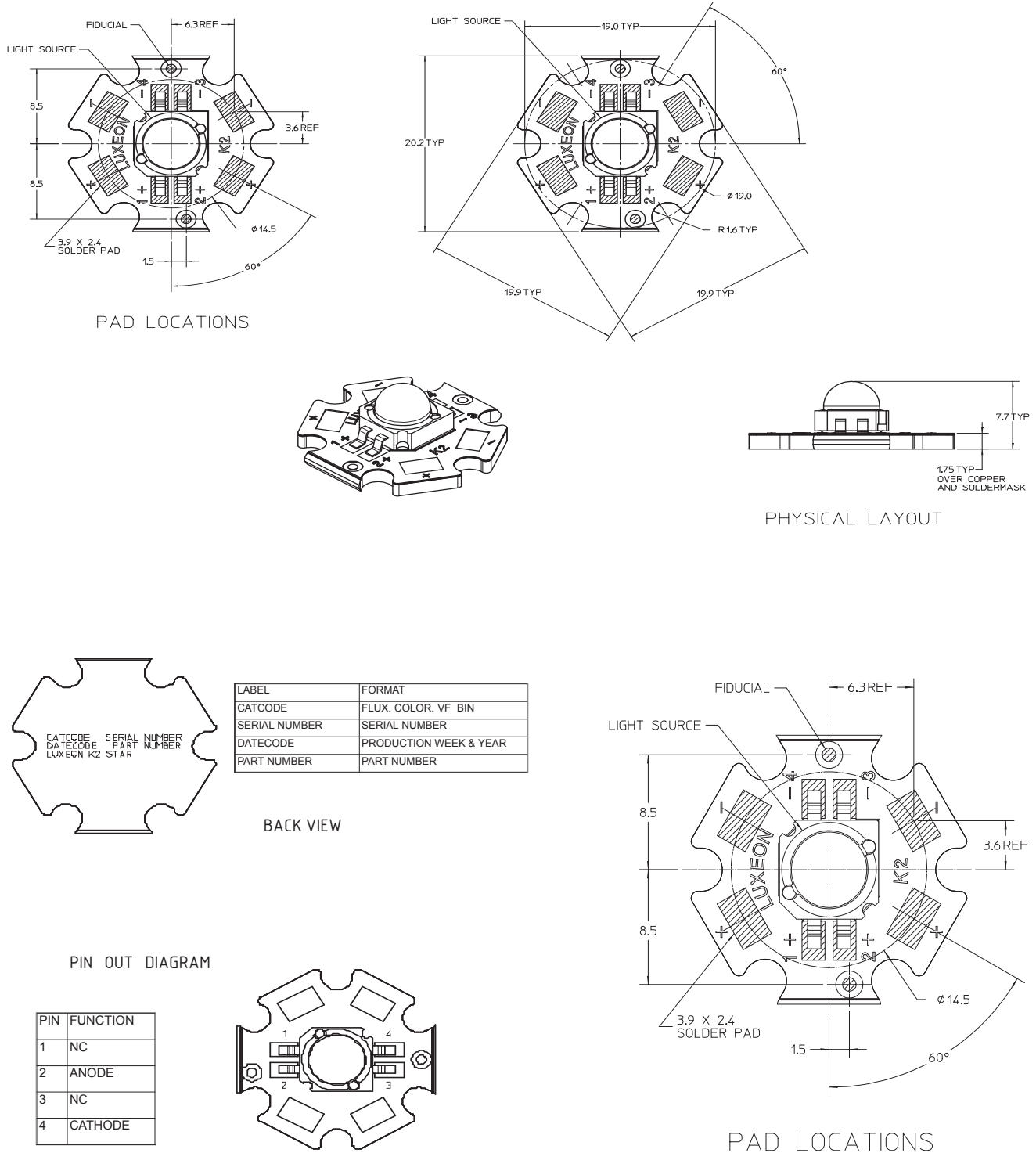

Figure 9. K2 Star Package Outline Drawing.

Notes for Figure 9:

1. Slots in aluminum core PCB for M3 or #4 mounting screw.
2. Electrical interconnection pads labeled on the aluminum core PCB with "+" and "-" to denote positive and negative, respectively. All positive pads are interconnected, as are all negative pads, allowing for flexibility in array interconnection.
3. Drawings not to scale.
4. All dimensions are in millimeters.

## Wavelength Characteristics

### Green, Cyan, Blue, Royal Blue, Red, Red-Orange and Amber at Test Current Junction Temperature, $T_J = 25^\circ\text{C}$

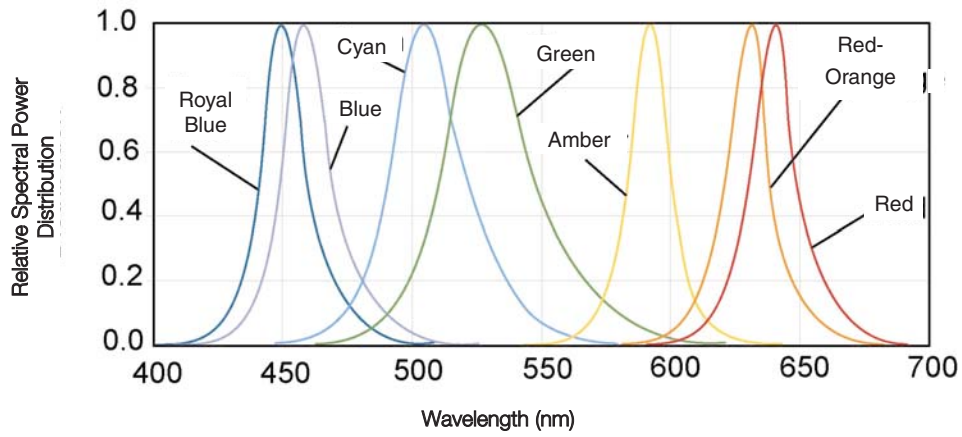

Figure 10. Relative intensity vs. wavelength.

### Cool-White at Test Current Junction Temperature, $T_J = 25^\circ\text{C}$

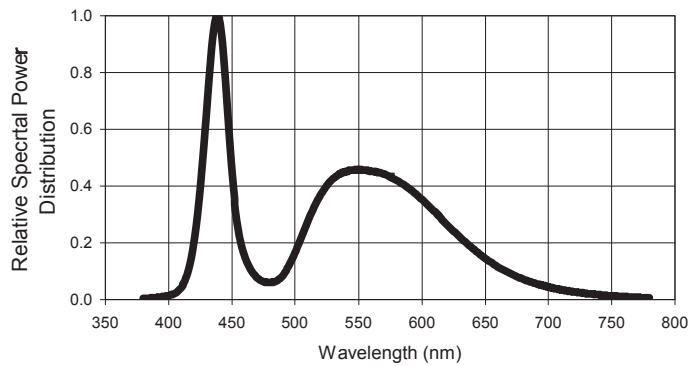

Figure 11a. Cool-White color spectrum of typical CCT part, integrated measurement.

## Wavelength Characteristics, Continued

### Neutral-White at Test Current Junction Temperature, $T_J = 25^\circ\text{C}$

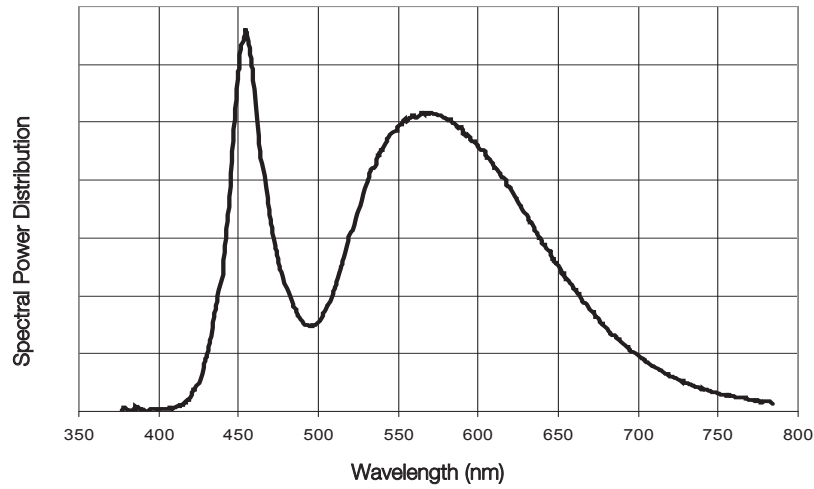

Figure 11b. Neutral-White color spectrum of typical CCT part, integrated measurement.

### Warm-White at Test Current Junction Temperature, $T_J = 25^\circ\text{C}$

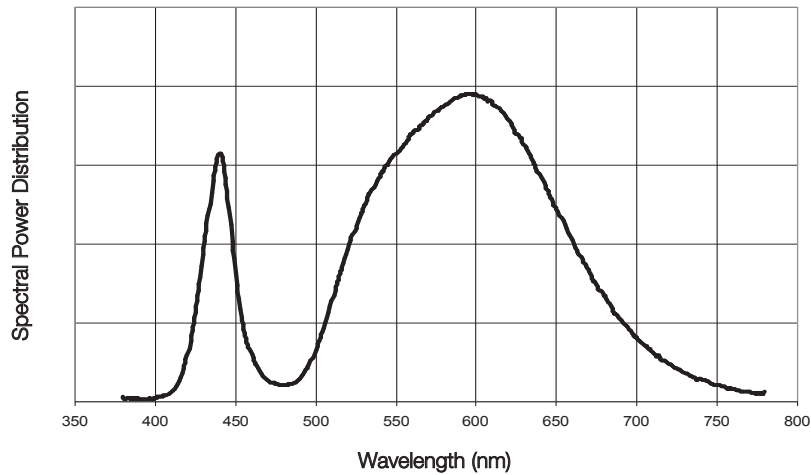

Figure 11c. Warm-White color spectrum of typical CCT part, integrated measurement.

## Typical Light Output Characteristics Over Temperature

Cool-White, Neutral-White and Warm-White at Test Current

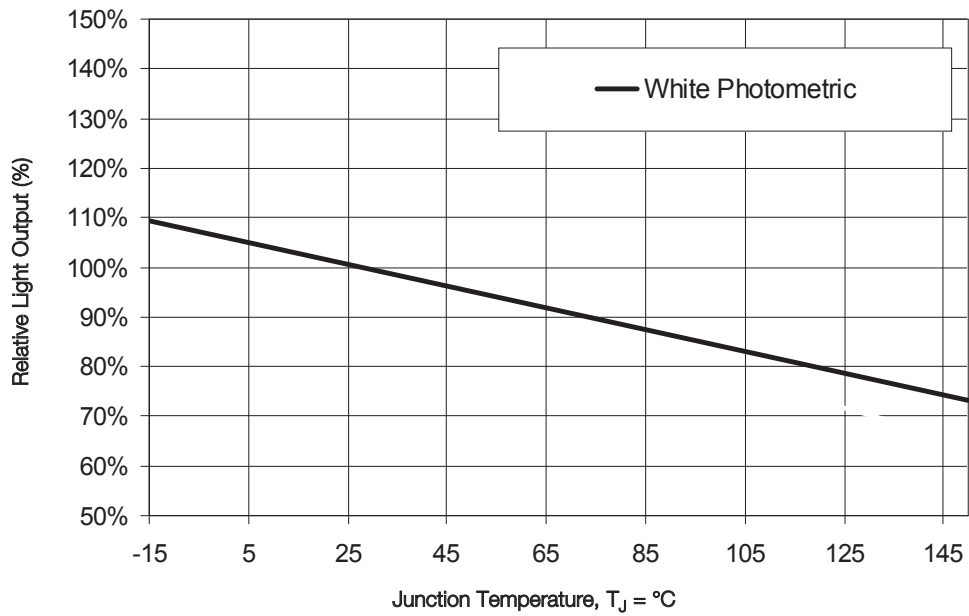

Figure 12a. Relative light output vs. junction temperature for white.

Green at Test Current

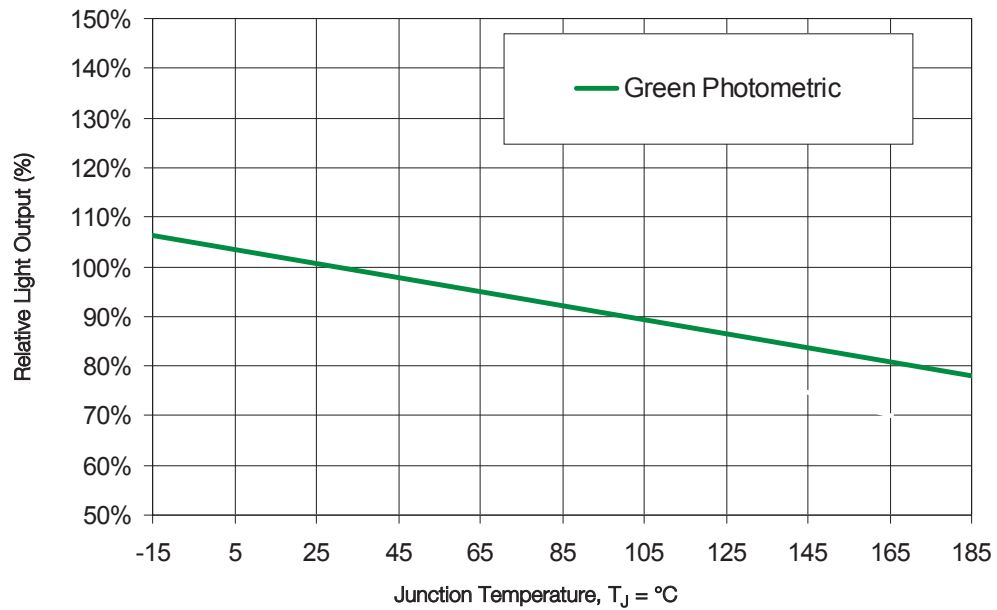

Figure 12b. Relative light output vs. junction temperature for green.

# Typical Light Output Characteristics Over Temperature, Continued

## Cyan at Test Current

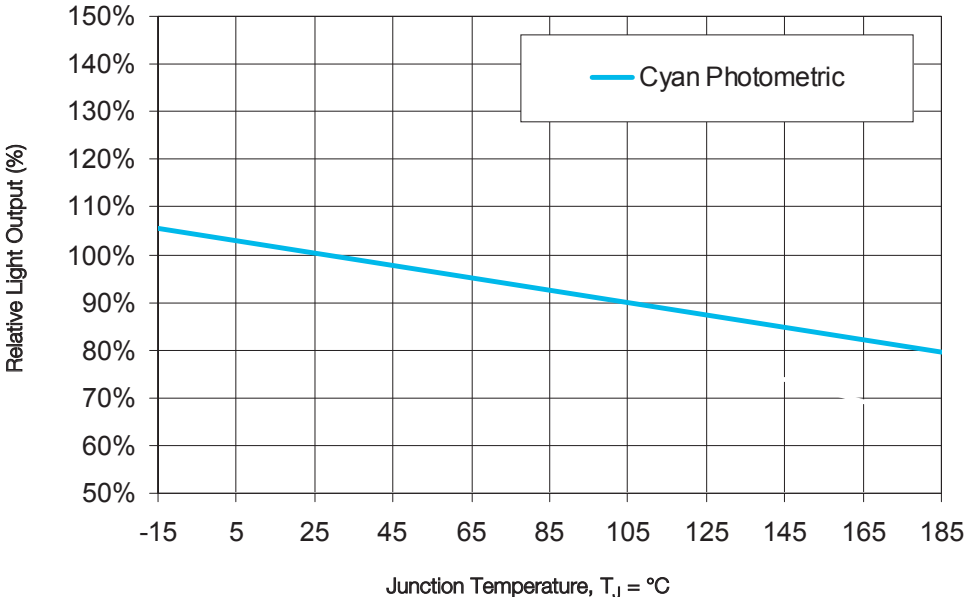

Figure 12c. Relative light output vs. junction temperature for cyan.

## Blue at Test Current

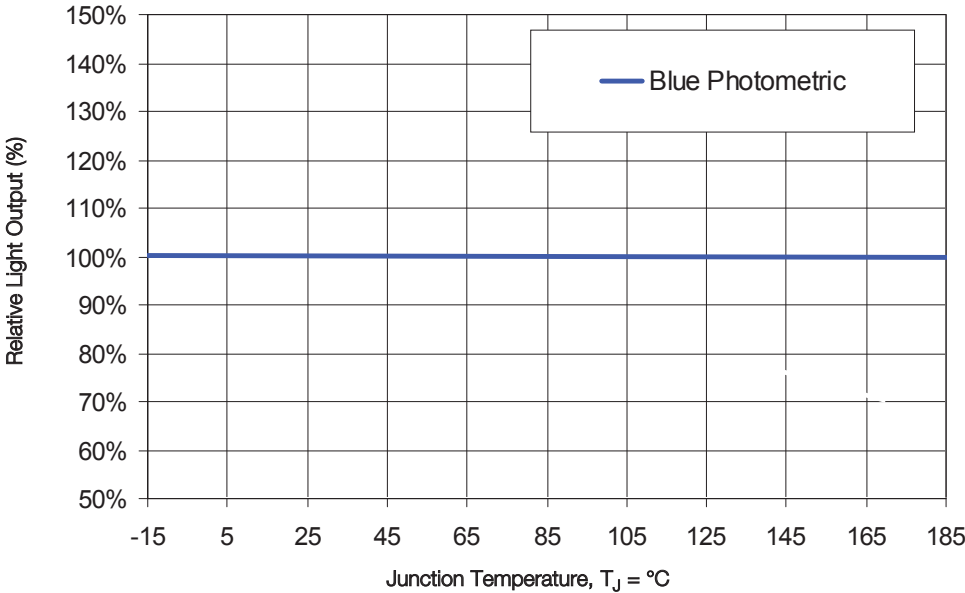

Figure 12d. Relative light output vs. junction temperature for blue.

# Typical Light Output Characteristics Over Temperature, Continued

## Royal Blue at Test Current

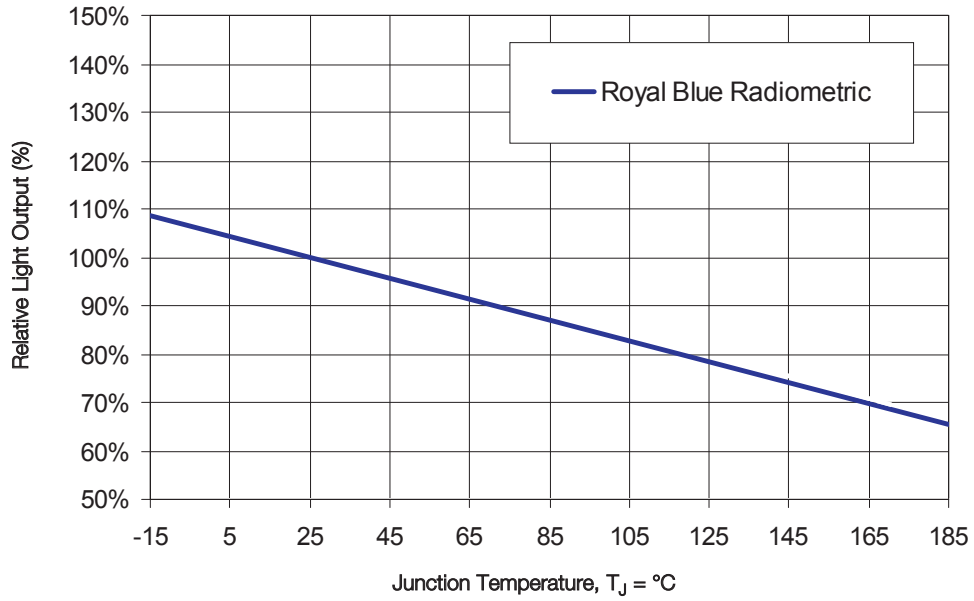

Figure 12e. Relative light output vs. junction temperature for royal blue.

## Red, Red-Orange and Amber at Test Current

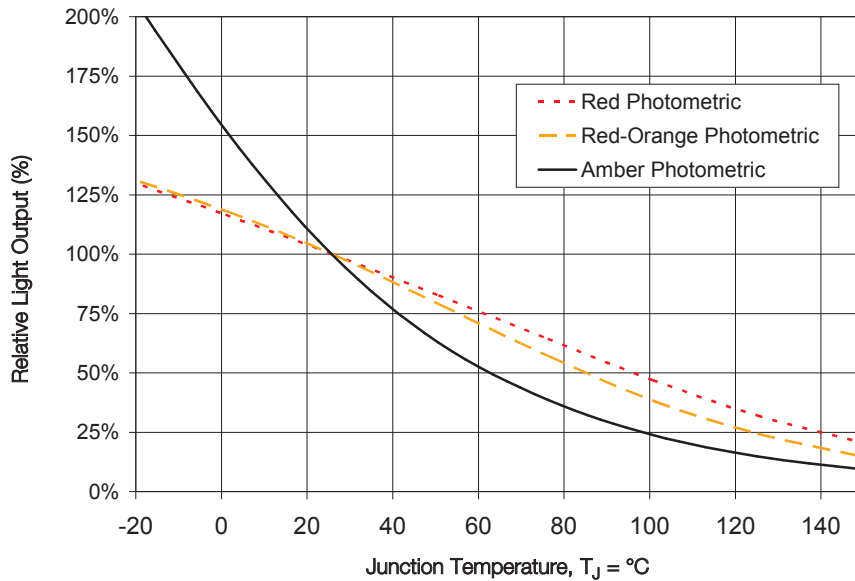

Figure 13. Relative light output vs. junction temperature for red, red-orange and amber.

## Typical Forward Current Characteristics

### Cool-White, Neutral-White, Warm-White, Green, Cyan, Blue and Royal Blue, Junction Temperature, $T_J = 25^\circ\text{C}$

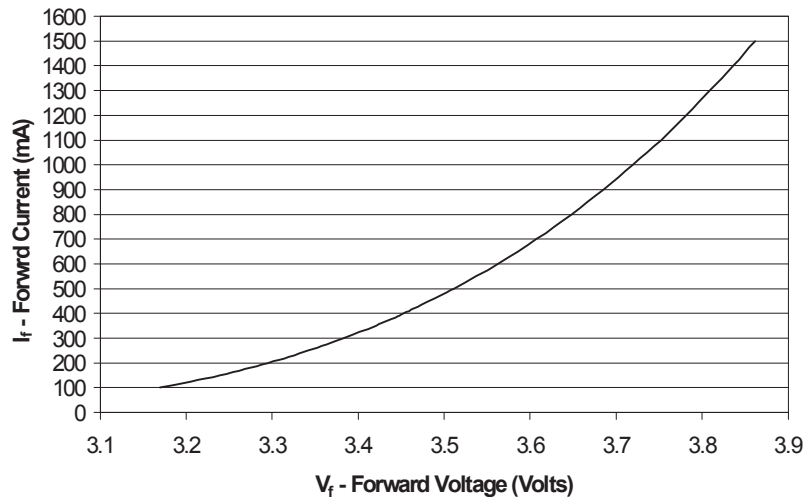

Figure 14. Forward current vs. forward voltage for white, green, cyan, blue and royal blue.

### Red, Red-Orange and Amber, Junction Temperature, $T_J = 25^\circ\text{C}$

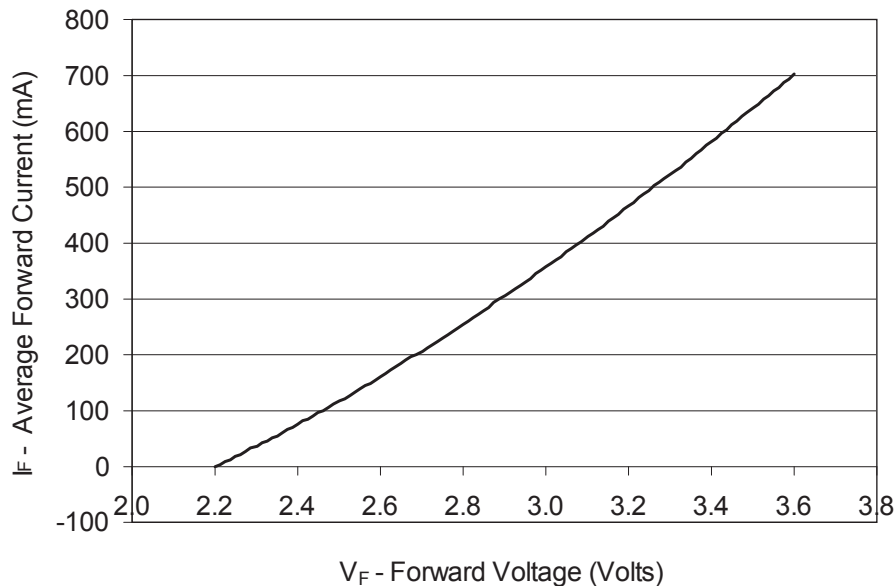

Figure 15. Forward current vs. forward voltage for red, red-orange and amber.

Notes for Figures 14 & 15:

Driving these high power devices at currents less than the test conditions (350 mA or 1000 mA) may produce unpredictable results and may be subject to variation in performance. Pulse width modulation (PWM) is recommended for dimming effects.



## Typical Relative Luminous Flux

### Relative Luminous Flux vs. Forward Current for Cool-White, Neutral-White, Warm-White, Green, Cyan, Blue and Royal Blue Junction Temperature, $T_J = 25^\circ\text{C}$

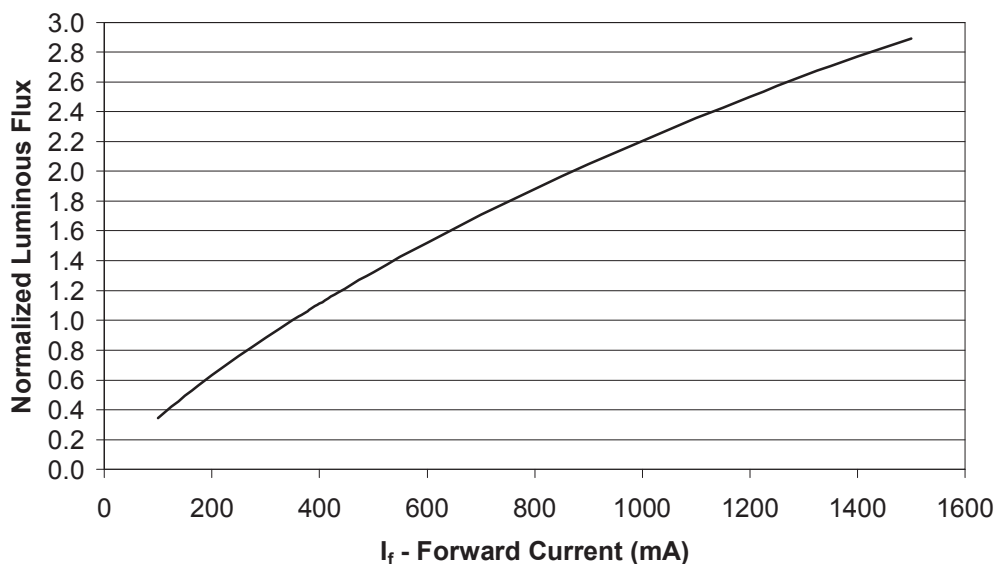

Figure 16. Relative luminous flux or radiometric power vs. forward current for white, green, cyan, blue and royal blue at  $T_J = 25^\circ\text{C}$  maintained, test current 350 mA.

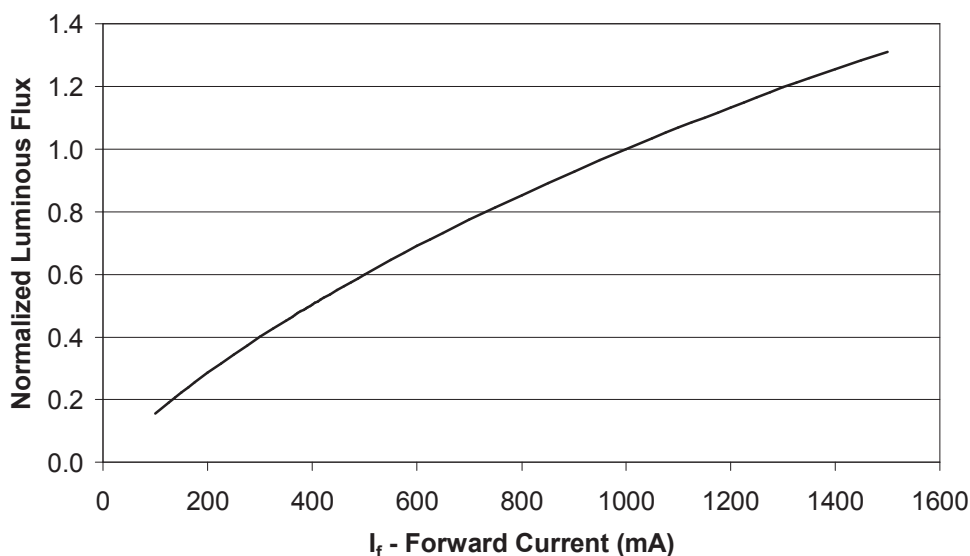

Figure 17. Relative luminous flux or radiometric power vs. forward current for white, green, cyan, blue and royal blue at  $T_J = 25^\circ\text{C}$  maintained, test current 1000 mA.

Notes for Figures 16 & 17:

Driving these high power devices at currents less than the test conditions (350 mA or 1000 mA) may produce unpredictable results and may be subject to variation in performance. Pulse width modulation (PWM) is recommended for dimming effects.

## Relative Luminous Flux vs. Forward Current for Red, Red-Orange and Amber, Junction Temperature, $T_J = 25^\circ\text{C}$

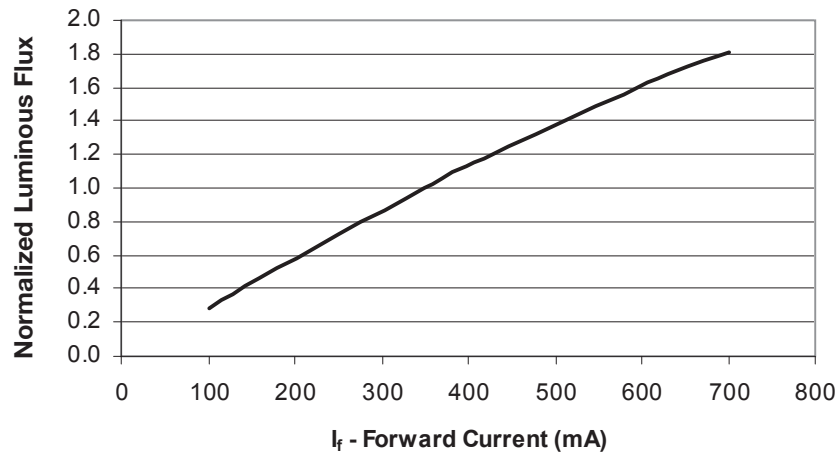

Figure 18: Relative luminous flux or radiometric power vs. forward current for red, red-orange and amber at  $T_J = 25^\circ\text{C}$  maintained, test current 350 mA.

Note for Figure 18:

Driving these high power devices at currents less than the test conditions (350 mA or 1000 mA) may produce unpredictable results and may be subject to variation in performance. Pulse width modulation (PWM) is recommended for dimming effects.

## Current Derating Curves

### Current Derating Curve for 350 mA Drive Current Cool-White, Neutral-White, Warm-White

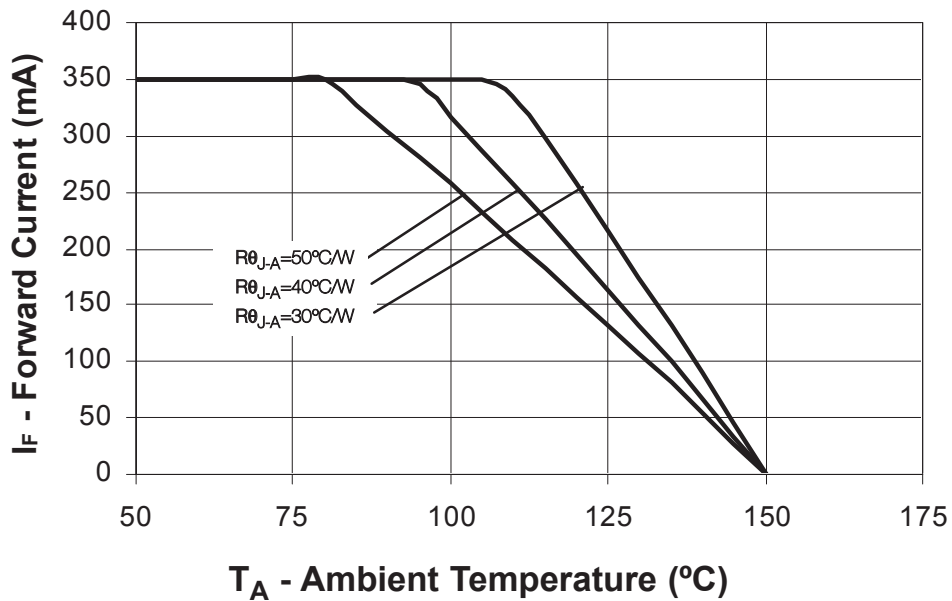

Figure 19: Maximum forward current vs. ambient temperature, based on  $T_{JMAX} = 150^\circ\text{C}$ .

### Current Derating Curve for 350 mA Drive Current Green, Cyan, Blue and Royal Blue

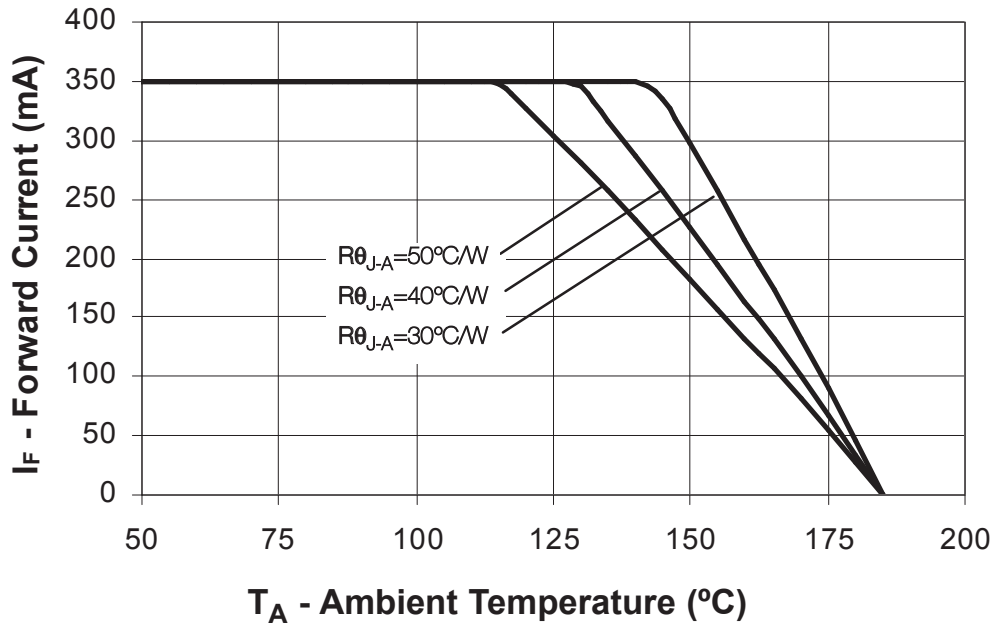

Figure 20: Maximum forward current vs. ambient temperature, based on  $T_{JMAX} = 185^\circ\text{C}$ .

## Current Derating Curve for 350 mA Drive Current Red, Red-Orange and Amber

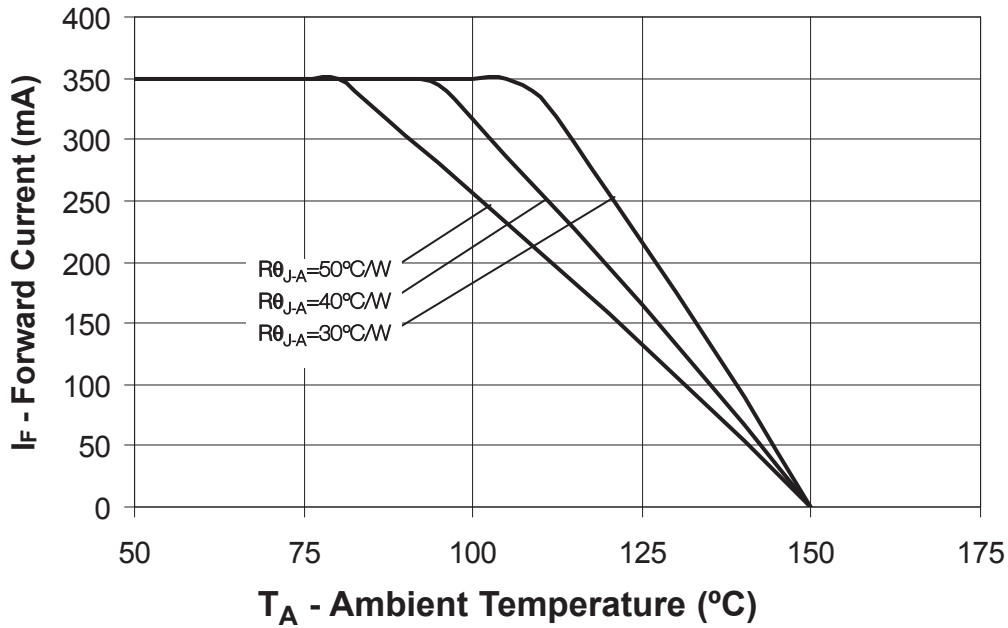

Figure 21: Maximum forward current vs. ambient temperature, based on  $T_{JMAX} = 150^\circ\text{C}$ .

## Current Derating Curve for 700 mA Drive Current Cool-White, Neutral-White, Warm-White

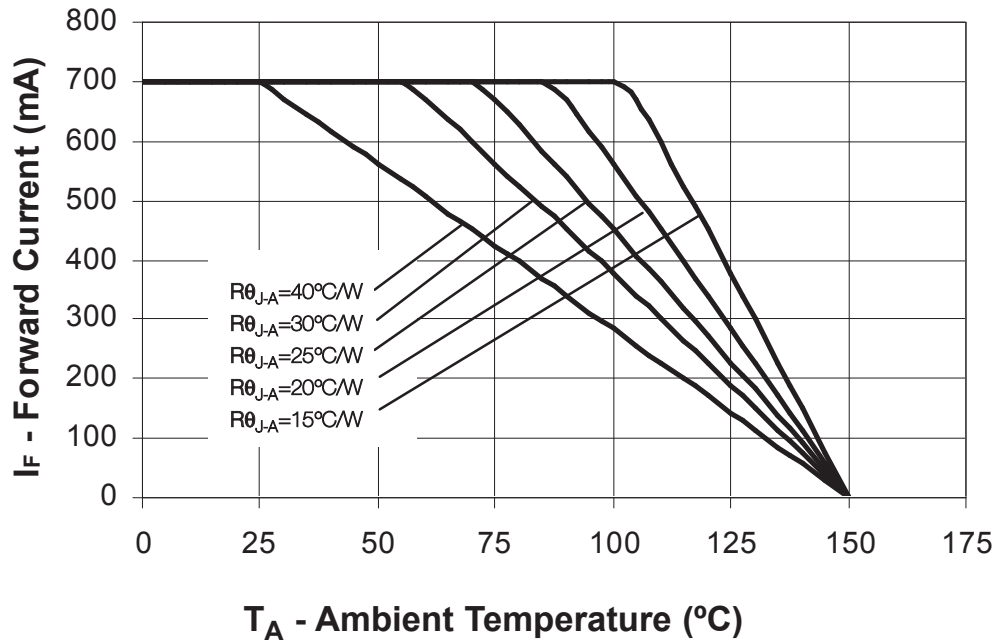

Figure 22: Maximum forward current vs. ambient temperature, based on  $T_{JMAX} = 150^\circ\text{C}$ .

## Current Derating Curve for 700 mA Drive Current Green, Cyan, Blue and Royal Blue

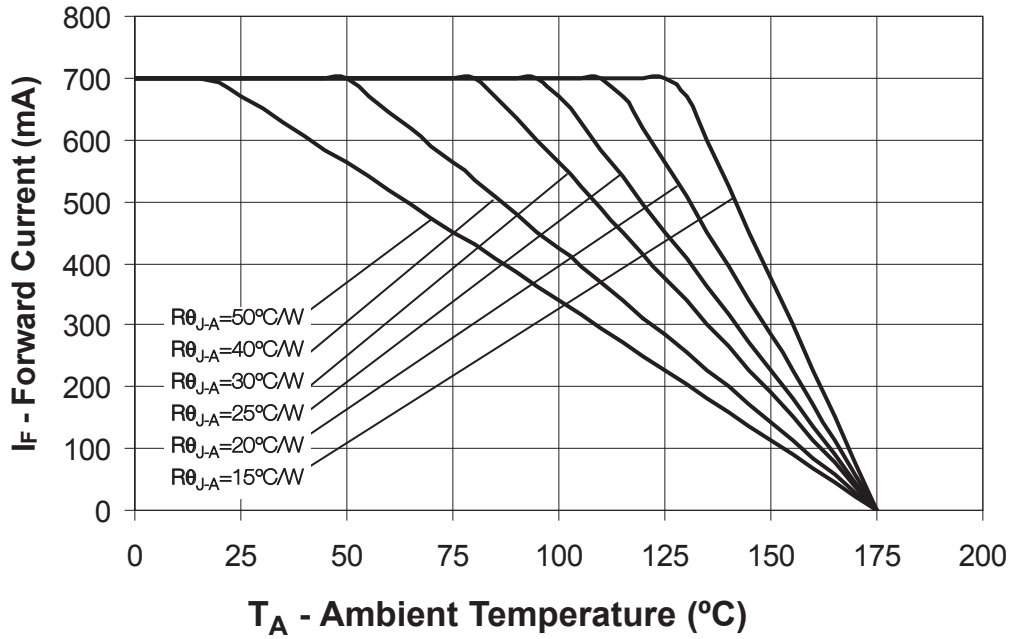

Figure 23: Maximum forward current vs. ambient temperature, based on  $T_{JMAX} = 175^\circ\text{C}$ .

## Current Derating Curve for 700 mA Drive Current Red, Red-Orange and Amber

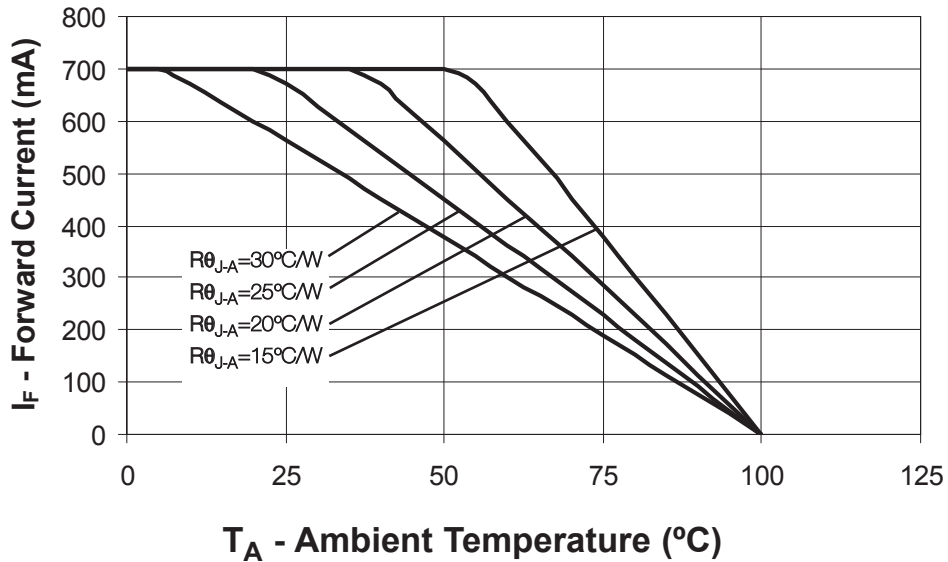

Figure 24: Maximum forward current vs. ambient temperature, based on  $T_{JMAX} = 100^\circ\text{C}$ .

## Current Derating Curve for 1000 mA Drive Current Cool-White, Neutral-White, Warm-White, Green, Cyan, Blue and Royal Blue

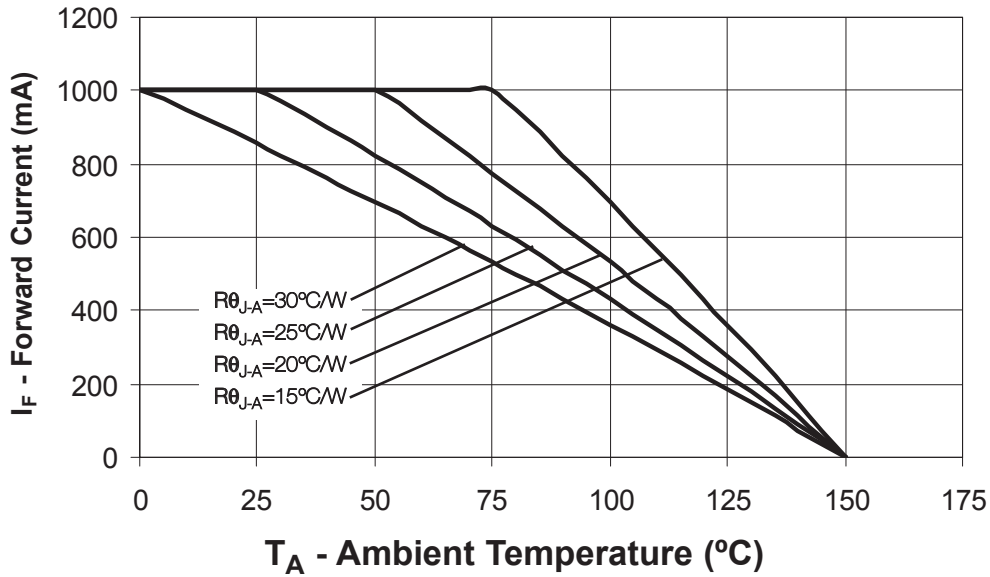

Figure 25: Maximum forward current vs. ambient temperature, based on  $T_{JMAX} = 150^{\circ}C$ .

## Current Derating Curve for 1500 mA Drive Current Cool-White, Neutral-White, Warm-White, Green, Cyan, Blue and Royal Blue

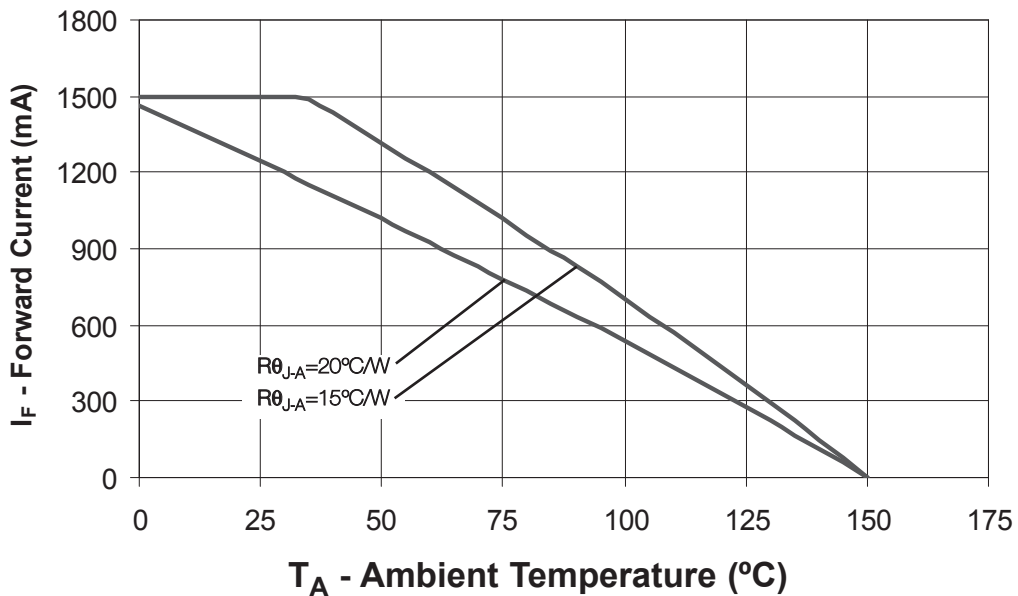

Figure 26: Maximum forward current vs. ambient temperature, based on  $T_{JMAX} = 150^{\circ}C$ .

## Typical Radiation Patterns

### Typical Representative Spatial Radiation Pattern for White Lambertian

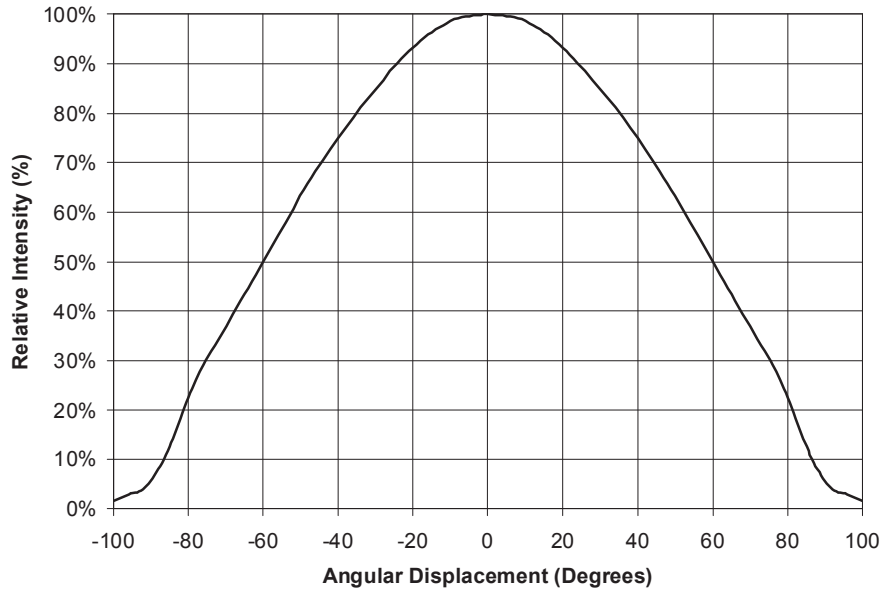

Figure 27: Typical Representative Spatial Radiation Pattern for White Lambertian.

### Typical Polar Radiation Pattern for White Lambertian

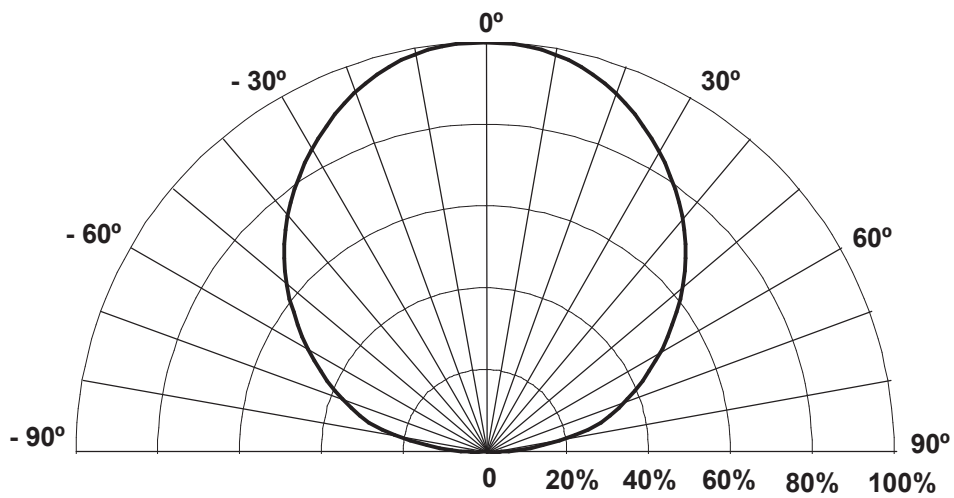

Figure 28: Typical Polar Radiation Pattern for White Lambertian.

## Typical Representative Spatial Radiation Pattern for Green, Cyan, Blue and Royal Blue Lambertian

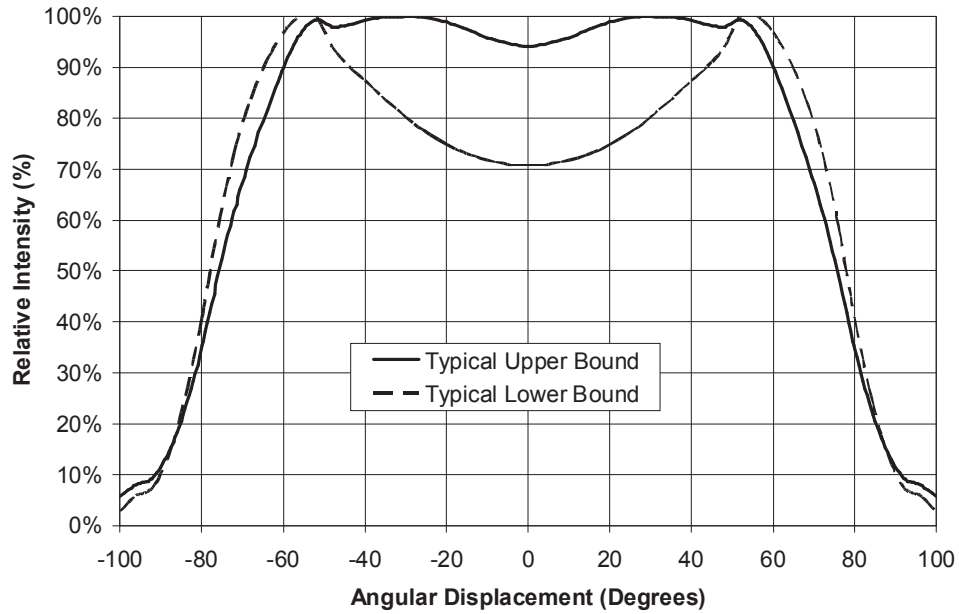

Figure 29: Typical Representative Spatial Radiation Pattern for Green, Cyan, Blue and Royal Blue Lambertian.

## Typical Polar Radiation Pattern for Green, Cyan, Blue and Royal Blue Lambertian

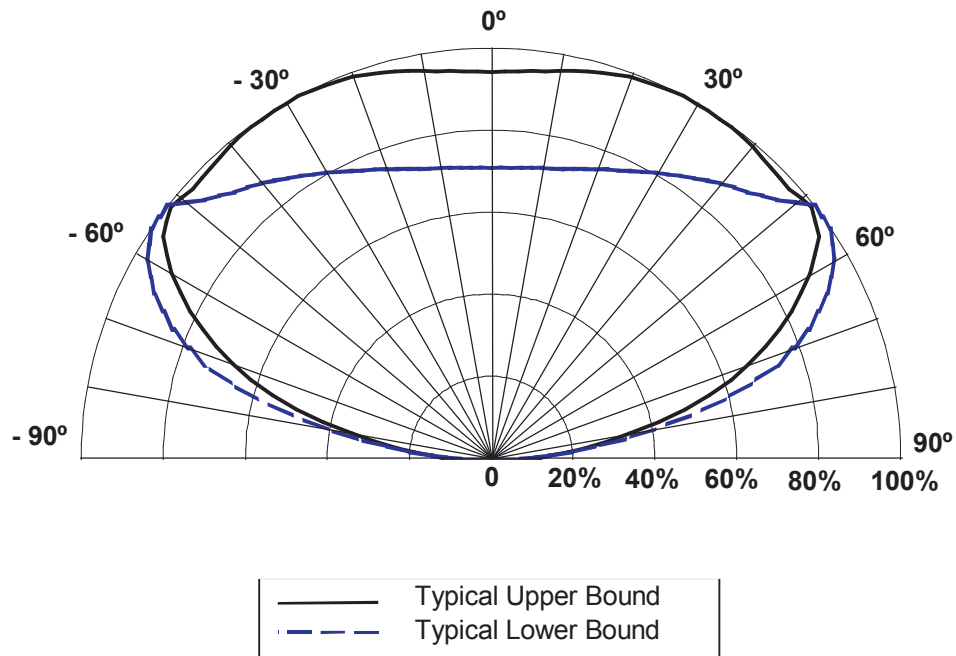

Figure 30: Typical Polar Radiation Pattern for Green, Cyan, Blue and Royal Blue Lambertian.



## Typical Representative Spatial Radiation Pattern for Red, Red-Orange and Amber Lambertian

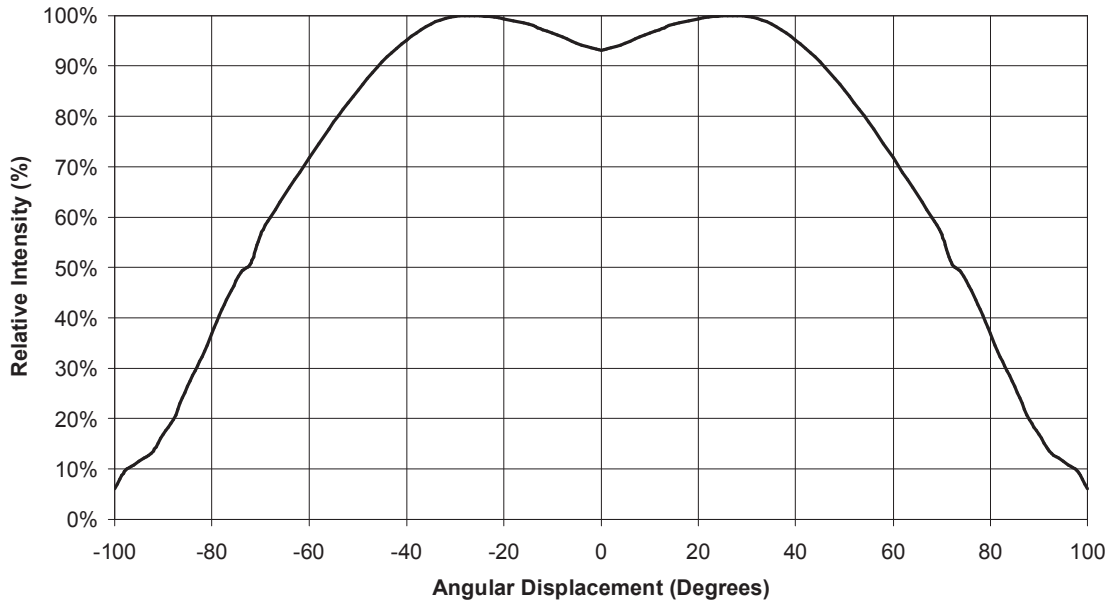

Figure 31: Typical Representative Spatial Radiation Pattern for Red, Red-Orange and Amber Lambertian.

## Typical Polar Radiation Pattern for Red, Red-Orange and Amber Lambertian

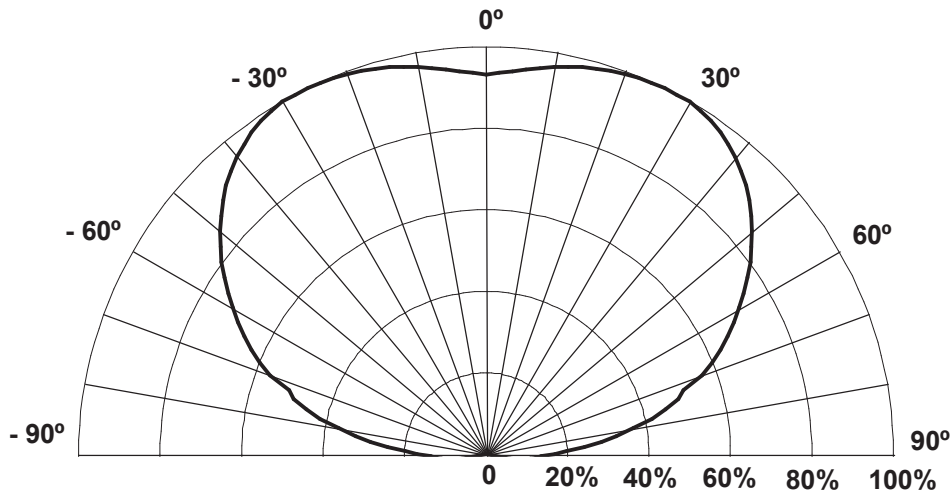
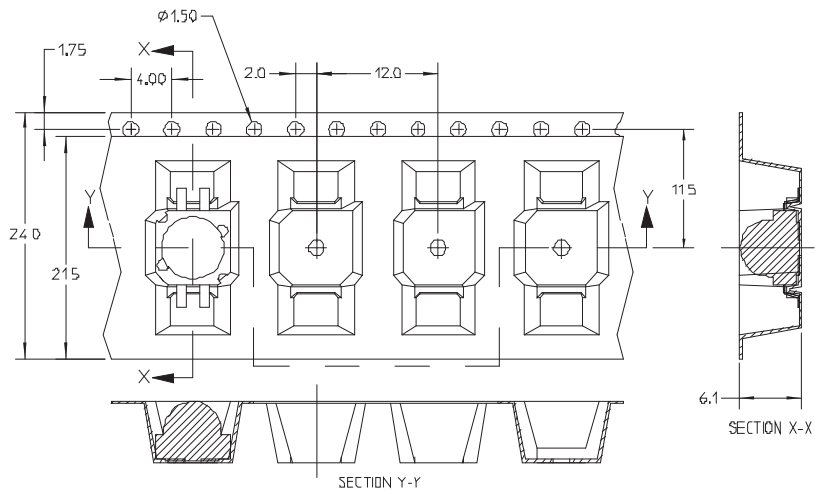
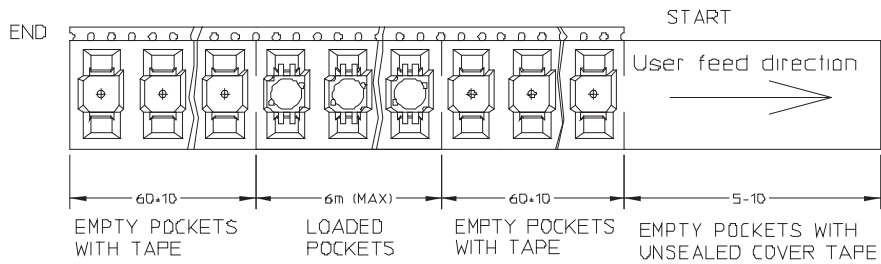
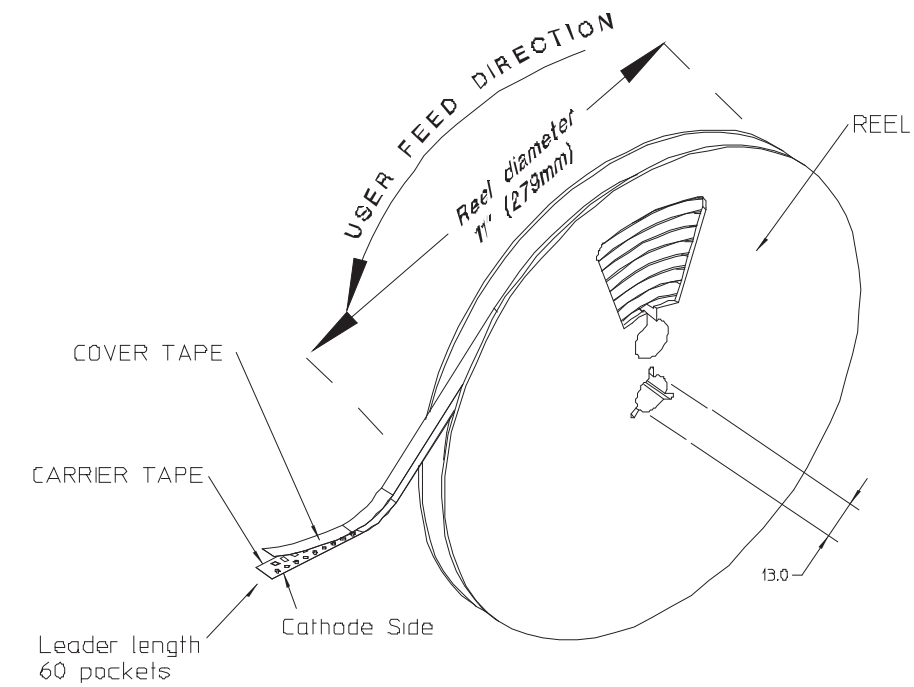

Figure 32: Typical Polar Radiation Pattern for Red, Red-Orange and Amber Lambertian.

# Emitter Reel Packaging



# White Binning Information

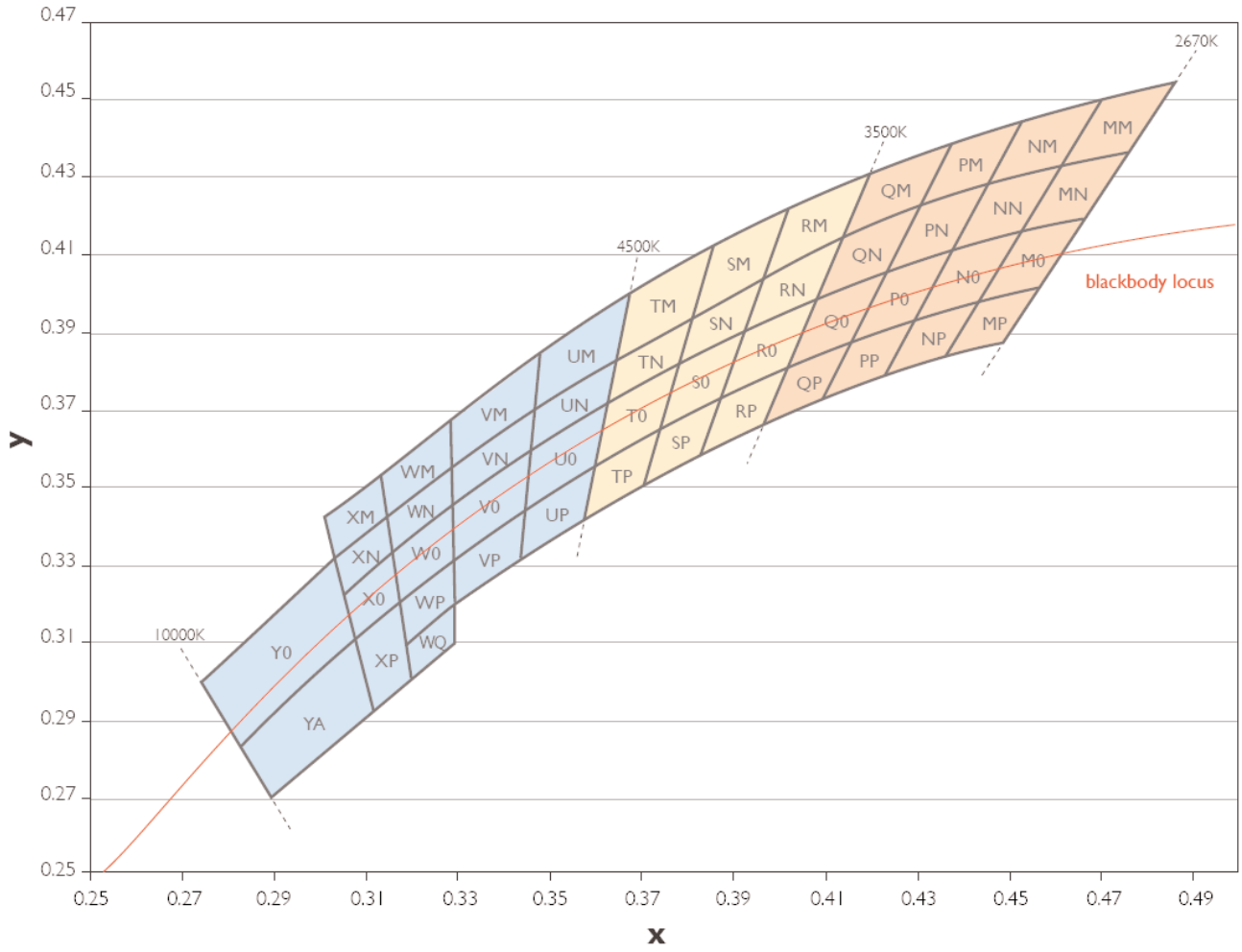

Figure 33: White Binning Structure

## LUXEON K2 Cool-White Bin Structure

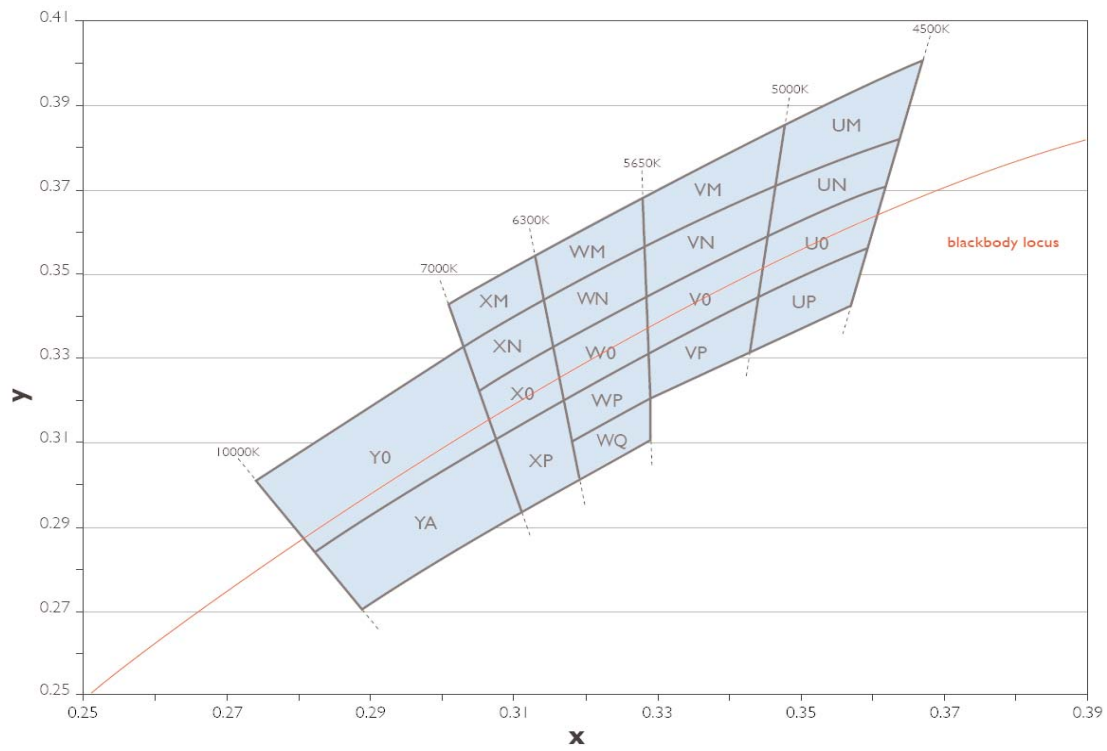

Figure 34: Cool-White Bin Structure

## LUXEON K2 Cool-White Bin Structure, Continued

Cool-White LUXEON K2 Emitters are tested and binned by x,y coordinates.

19 Color Bins, CCT Range 10,000K to 4,500K

Table 11.

Cool White Bin Structure							
Bin Code	X	Y	Typical CCT (K)	Bin Code	X	Y	Typical CCT (K)
Y0	0.274238	0.300667	8000	WQ	0.318606	0.310201	6000
	0.303051	0.332708			0.329393	0.320211	
	0.307553	0.310778			0.329544	0.310495	
	0.282968	0.283772			0.319597	0.301303	
YA	0.282968	0.283772	8000	VM	0.328636	0.368952	5300
	0.307553	0.310778			0.348147	0.385629	
	0.311163	0.293192			0.346904	0.371742	
	0.289922	0.270316			0.328823	0.356917	
XM	0.301093	0.342244	6700	VN	0.328823	0.356917	5300
	0.313617	0.354992			0.346904	0.371742	
	0.314792	0.344438			0.345781	0.359190	
	0.303051	0.332708			0.329006	0.345092	
XN	0.303051	0.332708	6700	V0	0.329006	0.345092	5300
	0.314792	0.344438			0.345781	0.359190	
	0.316042	0.333222			0.344443	0.344232	
	0.305170	0.322386			0.329220	0.331331	
X0	0.305170	0.322386	6700	VP	0.329220	0.331331	5300
	0.316042	0.333222			0.344443	0.344232	
	0.317466	0.320438			0.343352	0.332034	
	0.307553	0.310778			0.329393	0.320211	
XP	0.307553	0.310778	6700	UM	0.348147	0.385629	4750
	0.317466	0.320438			0.367294	0.400290	
	0.319597	0.301303			0.364212	0.382878	
	0.311163	0.293192			0.346904	0.371742	
WM	0.313617	0.354992	6000	UN	0.346904	0.371742	4750
	0.328636	0.368952			0.364212	0.382878	
	0.328823	0.356917			0.362219	0.371616	
	0.314792	0.344438			0.345781	0.359190	
WN	0.314792	0.344438	6000	U0	0.345781	0.359190	4750
	0.328823	0.356917			0.362219	0.371616	
	0.329006	0.345092			0.359401	0.355699	
	0.316042	0.333222			0.344443	0.344232	
W0	0.316042	0.333222	6000	UP	0.344443	0.344232	4750
	0.329006	0.345092			0.359401	0.355699	
	0.329220	0.331331			0.357079	0.342581	
	0.317466	0.320438			0.343352	0.332034	
WP	0.317466	0.320438	6000				
	0.329220	0.331331					
	0.329393	0.320211					
	0.318606	0.310201					

Note for Table 11:

1. Philips Lumileds maintains a tester tolerance of  $\pm 0.005$  on x, y color coordinates.

## LUXEON K2 Neutral-White Bin Structure

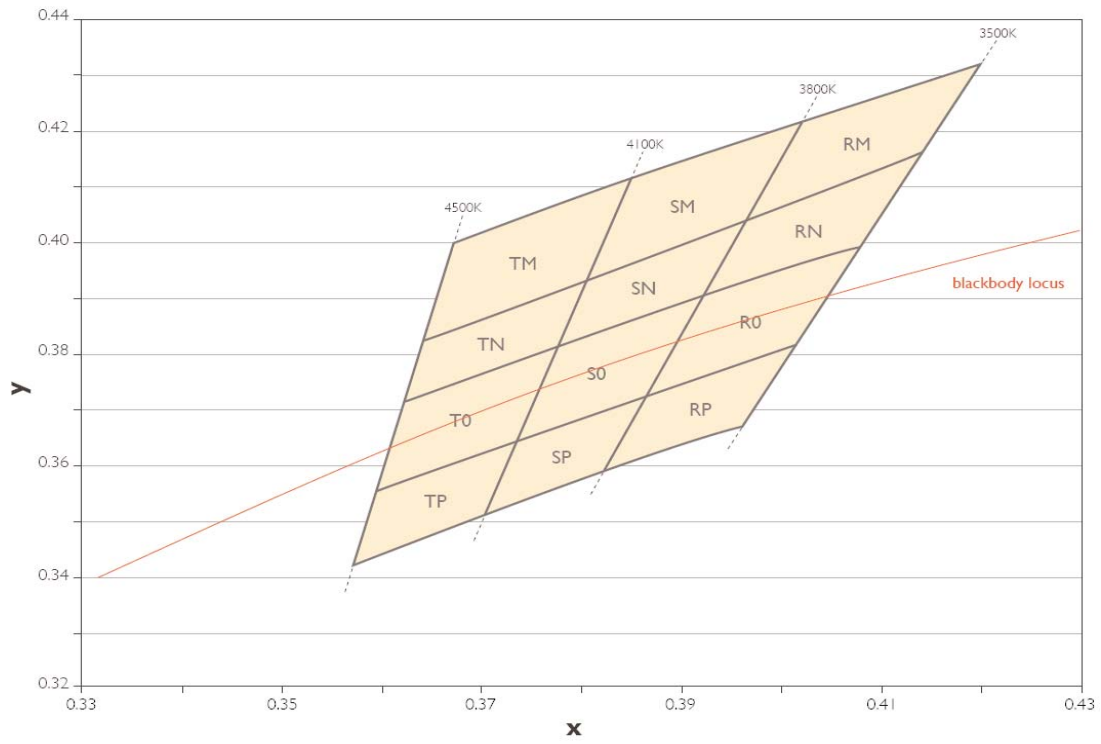

Figure 35: Neutral-White Bin Structure.

## LUXEON K2 Neutral-White Bin Structure, Continued

Neutral-White LUXEON K2 Emitters are tested and binned by x,y coordinates.  
12 Color Bins, CCT Range 4,500K to 3,500K

Table 12.

Neutral-White Bin Structure							
Bin Code	X	Y	Typical CCT (K)	Bin Code	X	Y	Typical CCT (K)
TM	0.367294	0.400290	4300	S0	0.378264	0.382458	3950
	0.385953	0.412995			0.392368	0.390932	
	0.381106	0.393747			0.387071	0.373899	
	0.364212	0.382878			0.374075	0.365822	
TN	0.364212	0.382878	4300	SP	0.374075	0.365822	3950
	0.381106	0.393747			0.387071	0.373899	
	0.378264	0.382458			0.382598	0.359515	
	0.362219	0.371616			0.370582	0.351953	
T0	0.362219	0.371616	4300	RM	0.402270	0.422776	3650
	0.378264	0.382458			0.420940	0.432618	
	0.374075	0.365822			0.414776	0.416097	
	0.359401	0.355699			0.396279	0.403508	
TP	0.359401	0.355699	4300	RN	0.396279	0.403508	3650
	0.374075	0.365822			0.414776	0.416097	
	0.370582	0.351953			0.408593	0.399525	
	0.357079	0.342581			0.392368	0.390932	
SM	0.385953	0.412995	3950	R0	0.392368	0.390932	3650
	0.402270	0.422776			0.408593	0.399525	
	0.396279	0.403508			0.402113	0.382156	
	0.381106	0.393747			0.387071	0.373899	
SN	0.381106	0.393747	3950	RP	0.387071	0.373899	3650
	0.396279	0.403508			0.402113	0.382156	
	0.392368	0.390932			0.396564	0.367284	
	0.378264	0.382458			0.382598	0.359515	

Note for Table 12:

1. Philips Lumileds maintains a tester tolerance of  $\pm 0.005$  on x, y color coordinates.

## LUXEON K2 Warm-White Bin Structure

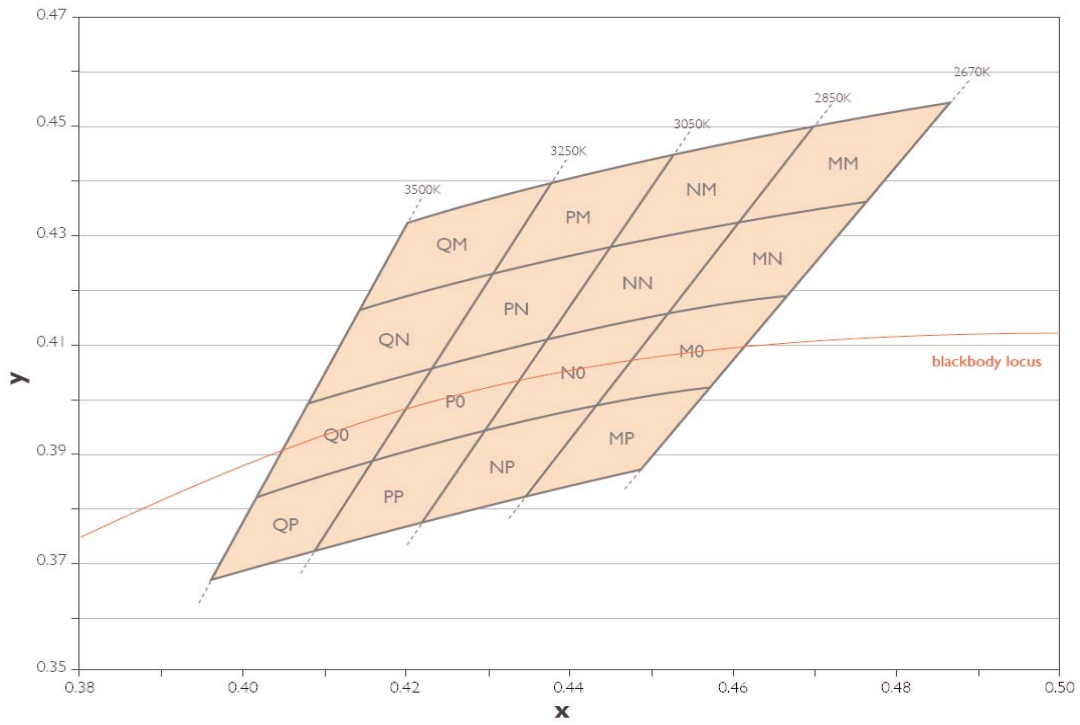

Figure 36: Warm-White Bin Structure.



## LUXEON K2 Warm-White Bin Structure, Continued

Warm-White LUXEON K2 Emitters are tested and binned by x,y coordinates.  
16 Color Bins, CCT Range 3,500K to 2,670K

Table 13.

Warm-White Bin Structure							
Bin Code	X	Y	Typical CCT (K)	Bin Code	X	Y	Typical CCT (K)
QM	0.420940	0.432618	3375	NM	0.453820	0.445980	2950
	0.438458	0.440399			0.470507	0.450832	
	0.431186	0.423386			0.461404	0.433334	
	0.414776	0.416097			0.445639	0.428680	
QN	0.414776	0.416097	3375	NN	0.445639	0.428680	2950
	0.431186	0.423386			0.461404	0.433334	
	0.423956	0.406472			0.452512	0.416241	
	0.408593	0.399525			0.437578	0.411632	
QO	0.408593	0.399525	3375	NO	0.437578	0.411632	2950
	0.423956	0.406472			0.452512	0.416241	
	0.416487	0.389001			0.443600	0.399111	
	0.402113	0.382156			0.429373	0.394281	
QP	0.402113	0.382156	3375	NP	0.429373	0.394281	2950
	0.416487	0.389001			0.443600	0.399111	
	0.409996	0.373814			0.435591	0.383714	
	0.396564	0.367284			0.422124	0.378952	
PM	0.438458	0.440399	3150	MM	0.470507	0.450832	2760
	0.453820	0.445980			0.486648	0.454191	
	0.445639	0.428680			0.476733	0.436634	
	0.431186	0.423386			0.461404	0.433334	
PN	0.431186	0.423386	3150	MN	0.461404	0.433334	2760
	0.445639	0.428680			0.476733	0.436634	
	0.437578	0.411632			0.467132	0.419632	
	0.423956	0.406472			0.452512	0.416241	
PO	0.423956	0.406472	3150	MO	0.452512	0.416241	2760
	0.437578	0.411632			0.467132	0.419632	
	0.429373	0.394281			0.457663	0.402866	
	0.416487	0.389001			0.443600	0.399111	
PP	0.416487	0.389001	3150	MP	0.443600	0.399111	2760
	0.429373	0.394281			0.457663	0.402866	
	0.422124	0.378952			0.448994	0.387515	
	0.409996	0.373814			0.435591	0.383714	

Note for Table 13:

1. Philips Lumileds maintains a tester tolerance of  $\pm 0.005$  on x, y color coordinates.



### Company Information

LUXEON® is developed, manufactured and marketed by Philips Lumileds Lighting Company. Philips Lumileds is a world-class supplier of Light Emitting Diodes (LEDs) producing billions of LEDs annually. Philips Lumileds is a fully integrated supplier, producing core LED material in all three base colors (Red, Green, Blue) and White. Philips Lumileds has R&D centers in San Jose, California and in The Netherlands and production capabilities in San Jose and Penang, Malaysia. Founded in 1999, Philips Lumileds is the high-flux LED technology leader and is dedicated to bridging the gap between solid-state LED technology and the lighting world. Philips Lumileds technology, LEDs and systems are enabling new applications and markets in the lighting world.

Philips Lumileds may make process or materials changes affecting the performance or other characteristics of our products. These products supplied after such changes will continue to meet published specifications, but may not be identical to products supplied as samples or under prior orders.



[WWW.LUXEON.COM](http://WWW.LUXEON.COM)  
[WWW.LUMILEDSFUTURE.COM](http://WWW.LUMILEDSFUTURE.COM)

FOR TECHNICAL ASSISTANCE OR THE LOCATION OF YOUR NEAREST SALES OFFICE CONTACT ANY OF THE FOLLOWING:

**NORTH AMERICA:**  
1 888 589 3662  
[AMERICAS@FUTURELIGHTINGSOLUTIONS.COM](mailto:AMERICAS@FUTURELIGHTINGSOLUTIONS.COM)

**EUROPE:**  
00 800 443 88 873  
[EUROPE@FUTURELIGHTINGSOLUTIONS.COM](mailto:EUROPE@FUTURELIGHTINGSOLUTIONS.COM)

**ASIA PACIFIC:**  
800 5864 5337  
[ASIA@FUTURELIGHTINGSOLUTIONS.COM](mailto:ASIA@FUTURELIGHTINGSOLUTIONS.COM)

**JAPAN:**  
800 5864 5337  
[JAPAN@FUTURELIGHTINGSOLUTIONS.COM](mailto:JAPAN@FUTURELIGHTINGSOLUTIONS.COM)

©2008 Philips Lumileds Lighting Company. All rights reserved. Product specifications are subject to change without notice. Luxeon is a registered trademark of the Philips Lumileds Lighting Company in the United States and other countries.

---