

SEP8506

GaAs Infrared Emitting Diode

FEATURES

- Side-emitting plastic package
- 50° (nominal) beam angle
- 935 nm wavelength
- Mechanically and spectrally matched to SDP8406 phototransistor, SDP8106 photodarlington and SDP8000/8600 series Schmitt trigger

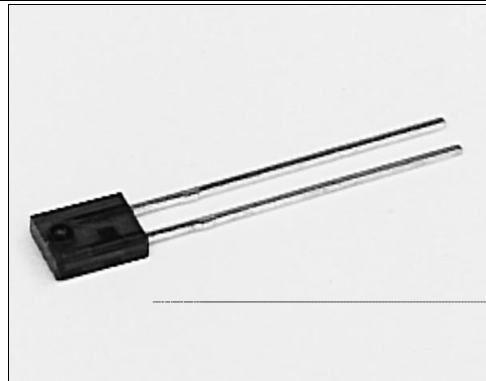

INFRA-20.TIF

DESCRIPTION

The SEP8506 is a gallium arsenide infrared emitting diode molded in a side-emitting red plastic package. The chip is positioned to emit radiation through a plastic lens from the side of the package.

OUTLINE DIMENSIONS in inches (mm)

Tolerance 3 plc decimals ±0.005(0.12)
2 plc decimals ±0.020(0.51)

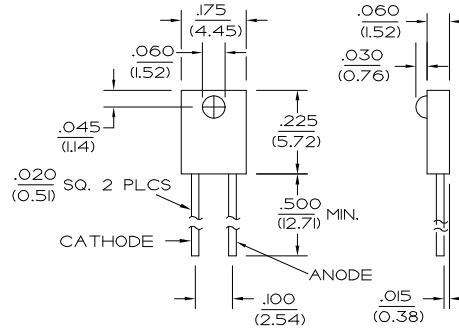

DIM_071.d64

SEP8506

GaAs Infrared Emitting Diode

ELECTRICAL CHARACTERISTICS (25°C unless otherwise noted)

PARAMETER	SYMBOL	MIN	TYP	MAX	UNITS	TEST CONDITIONS
Irradiance ⁽¹⁾	H				mW/cm ²	I _F =20 mA
SEP8506-001		0.05		0.36		
SEP8506-002		0.33		0.52		
SEP8506-003		0.45		0.90		
Forward Voltage	V _F			1.5	V	I _F =20 mA
Reverse Breakdown Voltage	V _{BR}	3.0			V	I _R =10 μA
Peak Output Wavelength	λ _p		935		nm	
Spectral Bandwidth	Δλ		50		nm	
Spectral Shift With Temperature	Δλ _p /ΔT		0.3		nm/°C	
Beam Angle ⁽²⁾	∅		50		degr.	I _F =Constant
Radiation Rise And Fall Time	t _r , t _f		0.7		μs	

Notes

1. Measured in mW/cm² into a 0.104 (2.64) diameter aperture placed 0.535 (13.6) from the lens tip.
2. Beam angle is defined as the total included angle between the half intensity points.

ABSOLUTE MAXIMUM RATINGS

(25°C Free-Air Temperature unless otherwise noted)

Continuous Forward Current	50 mA
Power Dissipation	100 mW ⁽¹⁾
Storage Temperature Range	-40°C to 85°C
Operating Temperature Range	-40°C to 85°C
Soldering Temperature (5 sec)	240°C

Notes

1. Derate linearly from 25°C free-air temperature at the rate of 0.78 mW/°C.

SCHEMATIC



Honeywell reserves the right to make changes in order to improve design and supply the best products possible.

Honeywell

SEP8506

GaAs Infrared Emitting Diode

Fig. 1 Radiant Intensity vs Angular Displacement gra_030.ds4

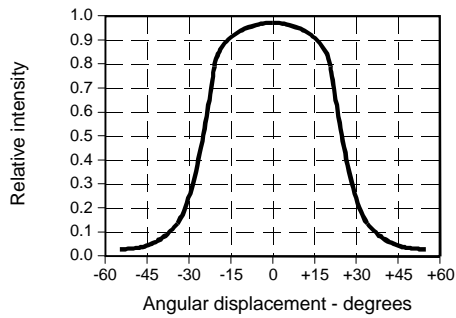

Fig. 2 Radiant Intensity vs Forward Current gra_028.ds4

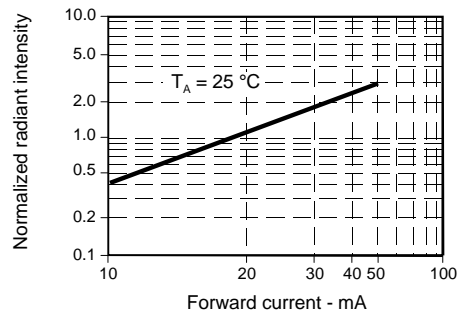

Fig. 3 Forward Voltage vs Forward Current gra_003.ds4

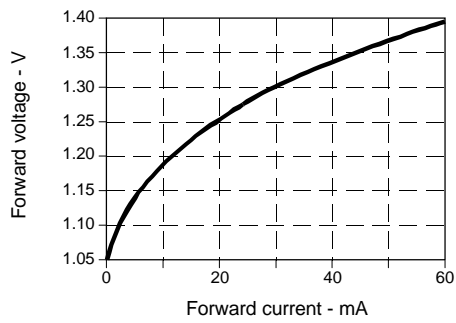

Fig. 4 Forward Voltage vs Temperature gra_207.ds4

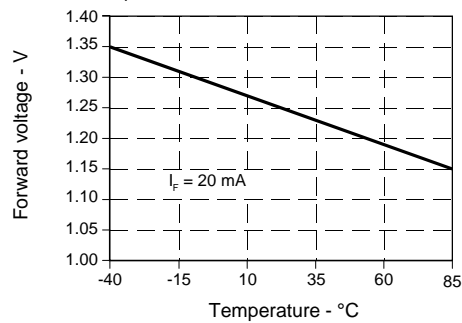

Fig. 5 Spectral Bandwidth gra_005.ds4

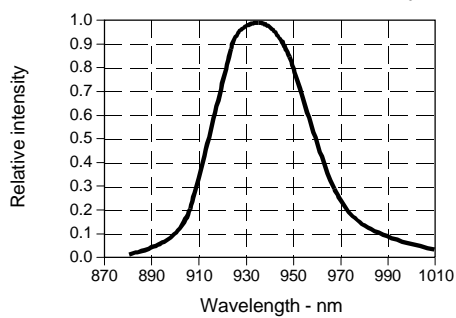
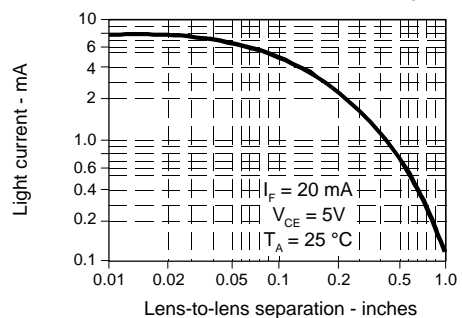
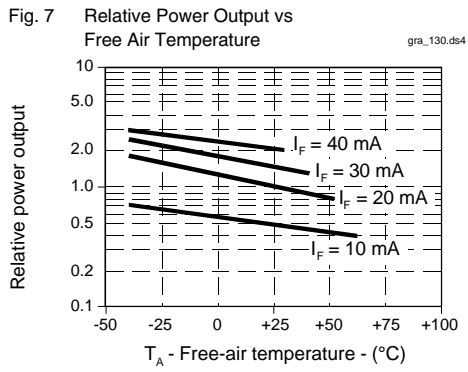

Fig. 6 Coupling Characteristics with SDP8406 gra_031.ds4



SEP8506

GaAs Infrared Emitting Diode



All Performance Curves Show Typical Values